



UNIVERSITÀ
DEGLI STUDI
FIRENZE

FLORE

Repository istituzionale dell'Università degli Studi di Firenze

Among the archaeologists and the designers: a critical survey of Sant'Andrea of Acre in Israel - Wśród archeologów i projektantów:

Questa è la Versione finale referata (Post print/Accepted manuscript) della seguente pubblicazione:

Original Citation:

Among the archaeologists and the designers: a critical survey of Sant'Andrea of Acre in Israel - Wśród archeologów i projektantów: krytyczna ankieta kościoła Sant'Andrea Akko w Izraelu / cecilia luschi. - In: CZASOPISMO TECHNICZNE. - ISSN 0011-4561. - STAMPA. - 11:(2018), pp. 27-38. [10.4467/2353737XCT.18.160.9416]

Availability:

The webpage <https://hdl.handle.net/2158/1142575> of the repository was last updated on 2019-01-03T10:38:41Z

Published version:

DOI: 10.4467/2353737XCT.18.160.9416

Terms of use:

Open Access

La pubblicazione è resa disponibile sotto le norme e i termini della licenza di deposito, secondo quanto stabilito dalla Policy per l'accesso aperto dell'Università degli Studi di Firenze (<https://www.sba.unifi.it/upload/policy-oa-2016-1.pdf>)

Publisher copyright claim:

La data sopra indicata si riferisce all'ultimo aggiornamento della scheda del Repository FloRe - The above-mentioned date refers to the last update of the record in the Institutional Repository FloRe

(Article begins on next page)

Cecilia Maria Roberta Luschi  orcid.org/0000-0002-7777-5360

cecilia.luschi@unifi.it

Dipartimenti di Architettura, University of Florence

AMONG THE ARCHAEOLOGISTS AND THE DESIGNERS: A CRITICAL SURVEY
OF SANT'ANDREA OF ACRE IN ISRAEL

WŚRÓD ARCHEOLOGÓW I PROJEKTANTÓW: KRYTYCZNA ANKIETA
KOŚCIOŁA SANT'ANDREA AKKO W IZRAELU

Abstract

We propose a historical architectural study of the hypogeum of the church of Sant'Andrea in Akko (Israel), which promoted new reflections on the urban historical fabric and at the same time provided concrete data for a redesign of part of the structure in line with the historical role and the building Hierarchy that made it a cornerstone for navigation and orientation at sea. The discovery of its architectural composition led the design to an extended dimension in addition to the building itself. We intend to propose a violation of contemporary architecture as a daughter of history and not as an assertion of modernity often detached from the context. In this case we try to recover the role and monumentality of the building, the urban context and the sea front.

Keywords: Izrael, archeology, historical research

Streszczenie

Artykuł stanowi opis historycznego studium architektonicznego hipogeum kościoła Sant'Andrea w Akko (Izrael), promujący nowe refleksje na temat miejskiej tkanki historycznej i dający konkretne dane do zaprojektowania części konstrukcji zgodnie z historyczną rolą i budową. Odkrycie kompozycji architektonicznej doprowadziło do rozszerzenia projektu poza sam budynek. Proponuje się rozumienie współczesnej architektury jako córki historii, a nie jako twierdzenie o nowoczesności często oderwanej z kontekstu. W tym konkretnym przypadku proponuje się odzyskanie roli i monumentalność budynku w kontekście miejskim i morskim.

Słowa kluczowe: Izrael, archeologia, badania historyczne

The work which is presented, in addition to being an advanced historical research, represents a more geometric and proportional route to the mediaeval project.

The geometric relationships and composition compared with the functional hypothesis of the structure, give us a knowledge of the architectural design of the building.

The road that follows is that of being able to recover all the historical and cultural heritage of the artefact itself, and to be able to propose its preservation and its functional reuse within the historical logic. There seems to be a step towards a new type of enhancement that provides dignity to the building and especially to what it has been through the ages.

Around Sant'Andrea, gradually, there are many interests that have added up. What prompted us to deepen the knowledge of the church of Sant'Andrea is a famous text that reads as follows:

*Acri è golfo et bom porto e qua è uno scollio che fai lo porto.
Alli quali scollii potete stare a prodesse en fondo de iiiij passi.
E de ver terra ferma è la torre delle mosche. La 'ntrata de lo porto è entre la dicta torre e li scollii.
Se venite a lo dicto porto, va lontano a la città, coè a ssavere a la macone dello templo et alla chiesa de lo sancto Andrea iiiij, prodesse per la secca che ède sopra Sancto Andrea. E quando averete la mancone che fo de lo Conestavele a dericto de la torre de le mosche, potete far la via a lo porto dericta. E quando entrarete a lo porto, va tanto entro che aibate la citta de Cayfas en mecca poppe da levante, e la torre delle mosche per mecca proda. E cosi girate allo porto nepto della dicta secca [1].*

*Acri is a gulf and good port, and here there is a reef that protects the port.
You can in stand by to be moored with a bow and a 140 metre-long rope.
On the mainland is the tower of flies. The entrance to the port is between the tower and the rocks. If you arrive at this port, go far from the city, that is, off the Templar Matter and the church of Sant'Andrea because there is a bank in front of Sant'Andrea.
When you have aligned the tower of the temple with the Tower of the Flies, you can go straight in parallel. To enter the port you must navigate until Haifa is half aft from the east, and the Tower of the Flies in the middle of the bow.
And so you enter the port avoiding the reefs (Fig. 1).*

It is the most ancient Mediterranean Portolan text to be used as a Compass to navigate, anonymous and undated, the historian mediaevalist Bacchisio R. Motzo found it over thirty years ago in an archive of Alghero in Sardinia. The Compass is recommended to navigate four miles away from Saint Andrew's shoal and look over the Templar mansion and the church of Sant'Andrea to get into the port without damage. As just reported, giving importance to the church is no longer local but becomes an excellent land marker and a sea warning for navigation.

It becomes the meeting point between land and sea and all that is represented by architecture. We enter then into the depths of the underground site and architecture studied, and try to understand it as it appears.

Direct survey now seems obsolete in favour of high technologies like 3D surveys, but in reality it has a unique potential, which is to confront the structures for a long time and look at

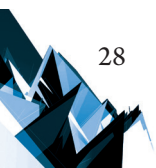

them and see them day by day, interrogate them stone by stone and pillar after pillar. The need to get caught between the building structures and to be immersed in the structural design, promotes a different understanding and a different approach to the cognitive process. At this time we would like to present this kind of observation and investigation that does not exclude the methodological rigour and metrical precision, but adds a personal feeling towards the architecture.

From the above, a method follows that does not rely on preconceived ideas. Often it is better to know nothing of the structure that is to be investigated, to be free to read every possible architectural variant that arises, (for this assertion I apologize to historians and archaeologists, who I read a lot, always after my analyses).

A matter to be clarified concerns the measurement concept in the classical or mediaeval period. Today, the measure for us has a value in metres and starts from zero. But this can only happen in an environment where zero is known.

The measure for a classical or mediaeval manufacturer starts from 1 and contemplates a quantity the 1 is already a quantity itself [2, 3]¹.

The other problem is the irrational quantity such as the 2 radical or the radical 3, known as the diagonal of a square or a cube. But in geometry those measures are rational, they join two opposite corners of a square or a cube. Rationalization of irrational numbers passes directly from the use of the Pythagorean triples identifying square numbers which are in turn the sum of square numbers.

Given these premises, we can now enter the suggestive space of the Church of dell'ipogeo of Sant'Andrea in Acre.

After a day of observation, the architects definitively identify three types of different structures in terms of walls and floors (Fig. 2).

There are barrel covers lowered in the first room to the right of the access corridor.

Then we find the cross lounge, with a perimeter rib, excluding the first left evidently rebuilt in the following period.

In addition to this wide dizzying heights room, we find a narrow transverse corridor, which is parallel to the four newly outdated bays, divided by those from a wall with a sizeable section. We realize that the wall is independent of the main structure of the trusses that rest instead of pillars, except for the first left and the last to the right, where the trusses rest on extroflexions of the wall itself.

Entering into the hallway, a series of three ogival openings are arranged telescopically and narrow between the two septa which are not lying parallel to one another.

Besides this atypical and very curious structure, we know that there are two tanks that stand about 5 metres below and have no direct communication with these compartments.

We have chosen to focus on two main issues. The cisterns on one side and the underground vaulted on the other side.

¹ In the western world, the indi numbers was introduced for the first time, with the addition of zero to perform the positional calculation. Before then and until the modern era, Roman numerals were used with a base nomenclature of 5. (V; X; L; C; D; M -5; 10; 50; 100; 500; 1000).

The cross vaults have the characteristic to download the forces in accordance with the diagonal. The Forces are then collected from the wide section pillars. So the static calculation of the effort must be computed according irrational magnitudes and more with complex operations such as multiplication and division. The workers who do not know the numbers and then work with Roman numerals, definitely used a geometry protocol for static estimate. For correct critical investigation you should know that the measures taken orthogonally are often misleading with respect to the protocol implemented in the presence of cross structures so complex. The search for the geometric program must be carried out according to the diagonal, and still more difficult, should contain a quantity that is not accessible, or the section of the wall

Once consolidated the forces that could have compromised the immobility of the upper structures, it seems to have been decided to chain the crosswise structure by sacrificing one bay.²

It was decided to reinforce the transversality with a wall which, however, has an inclined trend respect to the system rationalized according to the diagonals of vaults of discharge. The reason for a structural redundancy of this kind is the need to be separated from the structure. That is, the bays fit across into the wall and exploits discharges like a vice.

The result is that the building wedge has no chance to slip or rotate, and has an autonomous foundation, thanks to the crosspieces, which divide the two septa.

As the net of openings could still exist between the two environments, we wondered why it was necessary to reestablish a part of the structure, (which also took place after seeing the confinement of the pillars and the building of a new one to support time). Something had to be changed in the management of the upper floors or at least the intention of making a remarkable rise buildings has led to a severe structural re-foundation.

The presence of the vacuum of the cisterns must have been known, with regard to the existing well within the inner section of the second span to the left, the opening surprised the builders that have changed the compositional design to avoid the wall leaning on the cisterns. They put in place then an ancient and effective, such as that used for example for the Ardica of Theodoric, or the so-called cryptoporticoes of Roman style foundation. A technique that raises the facade in complete autonomy with respect to the remainder of the building structure.

The façade in fact was not, as we now think, part of the structure of the body of the building, but was itself a separate building. It was the part of the building that spoke on the outside and was structured according to the monastic rules often borrowed from dall'ordini.

To sum up the facade of the church is a body composed of the western area arcades; it was open or closed (or Galilean or paradisum) and two knight towers to finish the scope of the construction.

What today is called Westwerk [4]³.

Let us read again the structure that we found, and try to see its composition better.

We said earlier that on the left of the entrance there is a small room with no connection to the rest of the structure, it might be the foundation of the left tower. To the right a "full" leads us to think that there may be the foundation of the tower on the right.

² The relief and critical reading of the structures, highlight the cut of the span with the continuous wall of plug. It is almost aligned with the current façade of the church on the upper floor

³ The Westwerk is simply the representation of the Gate of the celestial Jerusalem, and the architectural paradigm are the gates of the city of Rome

The ogival portion with its massive pillars, is the area that supports the Galilean superiorly, and the facade is brought from the foundation structure as we have seen, The façade, or the arduca, is located behind the line of the towers.

This outlines a fascinating piece of mediaeval period, two knight towers that defend the only central access.

The defensive structure in this case seems to be explicit and reasonable given the historical period and location, but as in all research there is always a “but.” If this was the shape of the facade, it would collide with the iconographic sources we have of St. Andrew, and then a dislocation problem opens that is not insignificant.

St. Andrew is like each other access to a Templar mansion that is proposed its rider with two towers to defend access.

However, today, this is the church of Saint Andrew and respecting the historical dynamics, we should work on the awareness that the current church perhaps occupies the historic Templar mansion. However, the studies carried out can provide a framework of territorial relationships that a project of reconstituting the façade can fix and involve [5].

The design of ancient buildings, according to the contemporary feel, is often relegated to a contagious museographic aspect. With conservation we propose a way that draws a lesson from the past. To refurbish sites where there is the possibility, it is a proposal to be evaluated. The Sant’Andrea of Acre, after having thoroughly studied its design genesis, has become an example of a study for refunctionalization.

The need for a new facade to the current church, draws its geometry and dimensions directly from the ancient structures, resting on them and protecting them.

The decentralized access is re-proposed as a verifiable limit for embarking on a journey between history and contemporaneity. The Church of Sant’Andrea appropriates ancient structures by using them and forming according to mediaeval design rules in a contemporary reading. The experimental proposal, and as such it must be interpreted, wants to promote a process of knowledge that becomes a driving force for the project of recovery and design. Everyday life from new life and sharing in the historical city and absolves its lesson of tradition and identity with the possibility of dialogue with the re-born context in a modern way.

Carlo Scarpa once said: I want to confess: I would like a critic to discover in my works certain intentions that I have always had. That is to say, an enormous desire to be within tradition, but without making capitals or columns, because they can no longer be done. Even a god would not invent an Attic base today⁴.

Work in September 2016, responsible Cecilia Luschi, Shally Peleg, Israeli Authority Authorities, with the kind permission of Father Andrea Baccus responsible for the church of Sant’Andrea in Akko.

Project proposal that starts from the elaborated historical data, with the purpose of reconstituting the prospect of the current church of Sant’Andrea is to recreate the hierarchy of the sea front and the dimensional relationships of the various building realities.

⁴ Carlo Scarpa Mille Cipressi, Conference in Madrid 1978, in F. Dal Co G. Mazziarol “Carlo Scarpa Opera Completa” Electa 1984–1992).

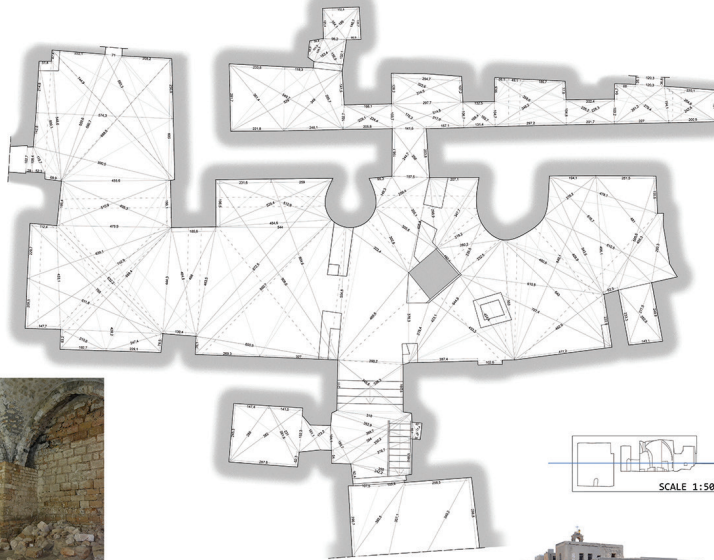

<p>UNIVERSITÀ DEGLI STUDI FIRENZE</p>	<p>ISRAEL ANTIQUITIES AUTHORITY</p>	<p>רשות העתיקות</p>	<p>STUDENTS</p> <ul style="list-style-type: none"> • Domenico Rivetti • Alessandra Vezzi • Federica Trudu • Alessandra Venturoli • Giacomo Martini • Eleni Katsilampi • Benedetta Zamboni 	<p>PROFESSORS</p> <ul style="list-style-type: none"> • Maria Cecilia Roberta Luschi • Yair Varon • Shelly-Jane Peleg • Michael Cohen 	7

SECTION CC'

WITH QUOTES AND PHOTOMOSAIC

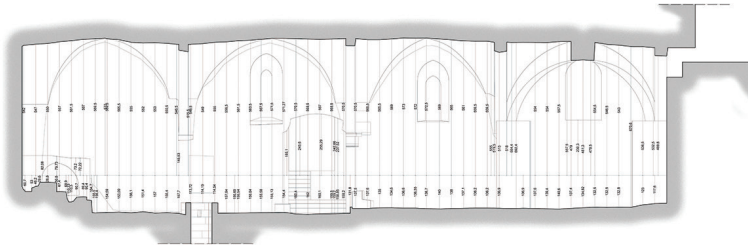

<p>UNIVERSITÀ DEGLI STUDI FIRENZE</p>	<p>ISRAEL ANTIQUITIES AUTHORITY</p>	<p>רשות העתיקות</p>	<p>STUDENTS</p> <ul style="list-style-type: none"> • Domenico Rivetti • Alessandra Vezzi • Federica Trudu • Alessandra Venturoli • Giacomo Martini • Eleni Katsilampi • Benedetta Zamboni 	<p>PROFESSORS</p> <ul style="list-style-type: none"> • Maria Cecilia Roberta Luschi • Yair Varon • Shelly-Jane Peleg • Michael Cohen 	10

Fig. 2, 3. Plan and Section of the ground floor on the archaeological level of the current church of Sant'Andrea

Study of alignments according to the module of the cubit

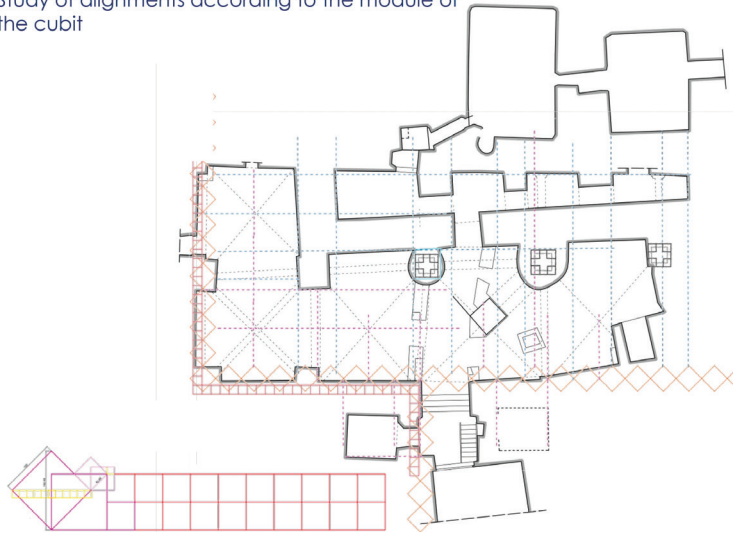

Fig. 4. Geometric schemes of equivalence between the Roman foot and the Royal Cubit, with geometrical relations for the realization of vaults and bays (elaborated by the author)

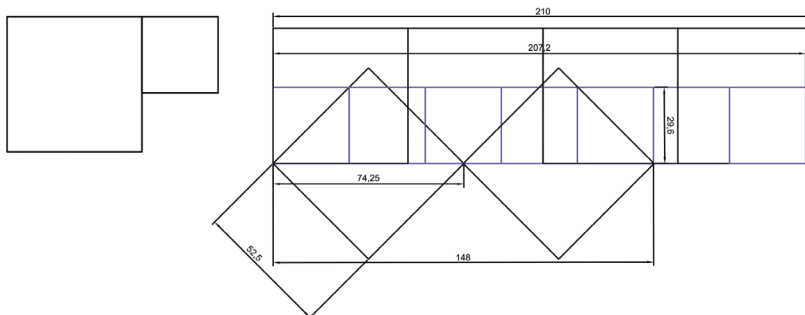

Fig. 5. Study according to the geometric protocol of the Sant'Andrea hypogeum, application of the original geometric proportions (elaborated by the author)

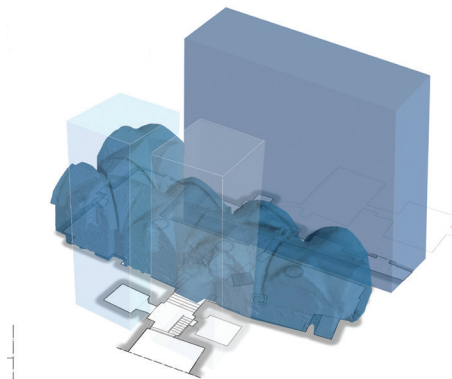

Fig. 6. Ardica di Teodorico (Ravenna), an example of the foundation of a façade in the late ancient period (author's photo)



Fig. 7



Fig. 8. The corridor of the hypogeum of the Sant'Andrea of Akko, which seems to populate the same foundation system designed to support a higher construction, today partly elided (author's photo)

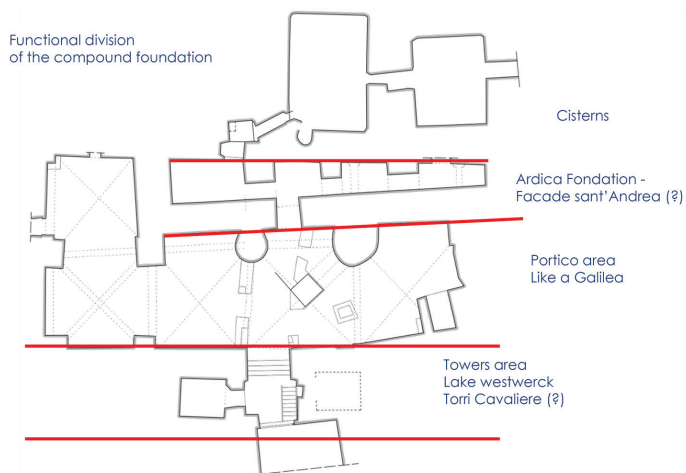
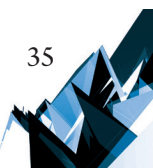

Fig. 9. Functional hypothesis of spaces. The transversal wall cuts the most ancient span going to form the corridor described above (elaborated by the author)



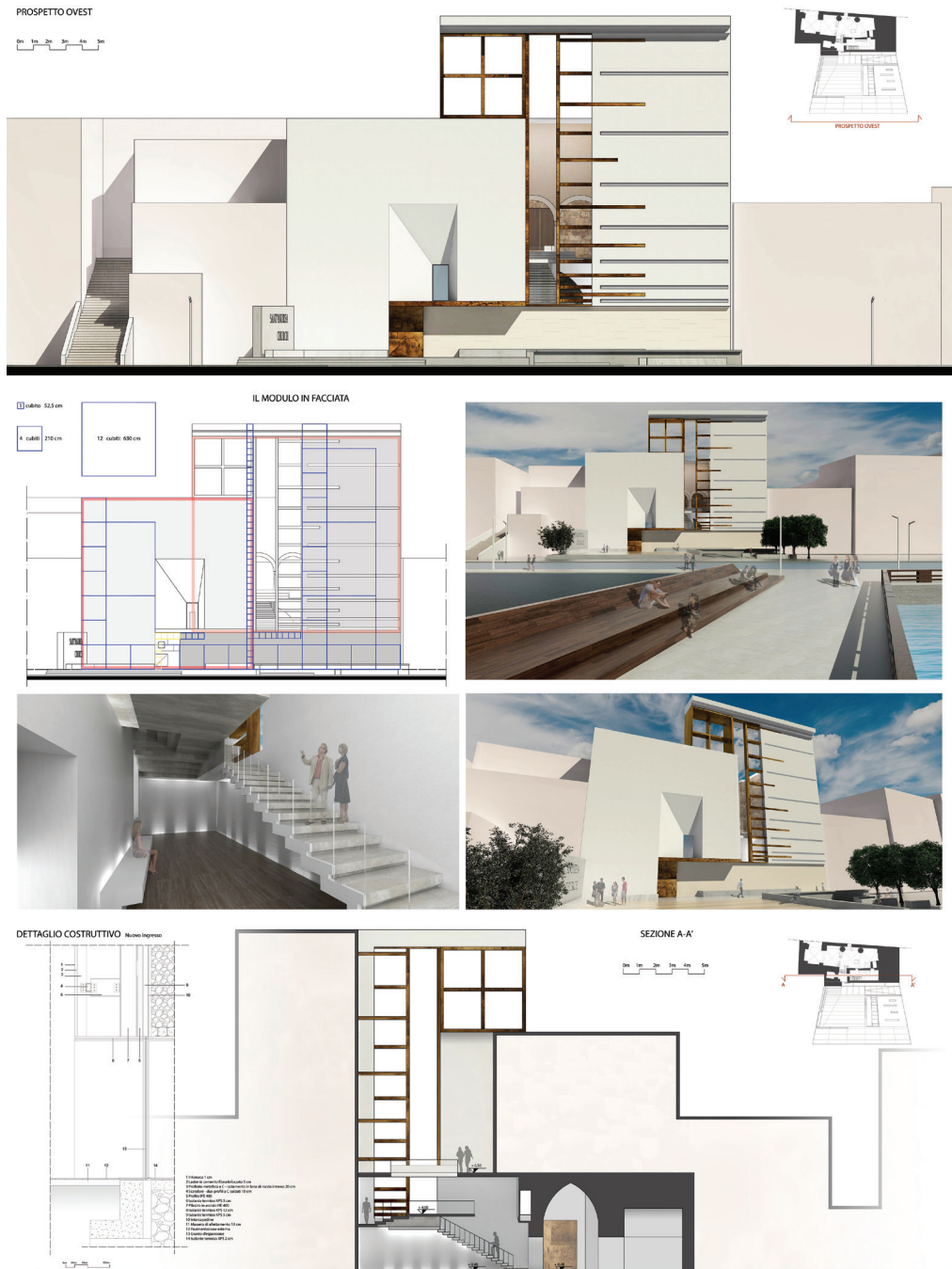

Fig. 11. Overall geometric analysis program, with direct relationships between wall sections and heights and subsequent reconstructive hypothesis (study by Luschi Cecilia and Alessandra Vezzi)

References

- [1] *Lo Compasso da Navigare*, ed. C. Hamilton 396, study by A. Debanne, P.I.E. Peter Lang, Bruxelles 2011.
- [2] Sigler L.E., *Fibonacci's Liber Abaci. A translation into modern english of Leonardo Pisano's book of calculation*, New York, Springer, 2003.
- [3] Luschi C.M.R., *Sui rapporti numerico matematici alla maniera di Federico II. Il castello di Prato. in MATEMATICA E ARCHITETTURA, Metodi analitici, metodi geometrici e rappresentazione in Architettura*, Alinea editrice, Firenze 2001.
- [4] Luschi C.M.R., *La Mistagogia del Monastero fra sintassi teologica e composizione Liturgica*, Aracne editrice, Roma 2015.
- [5] Carlo Scarpa Mille Cipressi, Conference in Madrid 1978, [in:] F. Dal Co G. Mazziarol, *Carlo Scarpa Opera Completa*, Electa 1984–1992.
- [6] [6] Luschi C.M.R., *La mistagogia del monastero fra sintassi teologica e composizione architettonica*, Arcane editrice, Roma 2015.