



Università degli Studi di Firenze

**DOTTORATO DI RICERCA IN SCIENZE CHIMICHE
SETTORE DISCIPLINARE CHIMICA ORGANICA CHIM/06
XXII CICLO**

*Synthesis of Isoxazole Derivatives by
Catalytic Condensation of Primary
Nitro Compounds with Dipolarophiles*

Elena Trogu

Tutor Prof. F. De Sarlo

Coord. Prof. G. Cardini

Co-Tutor Dr F. Machetti

2007-2009

A part of this thesis has been the object of publications and communications at meetings.

PUBBLICATIONS

F. Machetti, L. Cecchi, E. Trogu, F. De Sarlo; Isoxazoles and isoxazolines by 1,3-dipolar cycloaddition base catalysed condensation of primary nitro compounds with dipolarophiles. *Eur. J. Org. Chem.* **2007**, 4352-4359. (Chapter 2 of this thesis).

E. Trogu, F. De Sarlo, F. Machetti; Michael Addition versus Cycloaddition-Condensation of Ethyl Nitroacetate with Electron-deficient Olefins. *Chem. Eur. J.* **2009**, *15*, 7940-7948. (Chapter 3 of this thesis).

E. Trogu, L. Cecchi, F. De Sarlo, L. Guideri, F. Ponticelli, F. Machetti; Base- and copper-catalysed condensation of primary activated nitro compounds with enolisable compounds, *Eur. J. Org. Chem.* **2009**, 5971-5978. (Chapter 5 of this thesis).

E. Trogu, F. De Sarlo, F. Machetti; "In water" and "on water" condensation. Manuscript in preparation (Chapter 6 of this thesis).

CONFERENCE PRESENTATIONS AND SEMINARS

1) L. Cecchi, F. De Sarlo, F. Machetti, **E. Trogu**, Isossazoline e isossazoli via cicloaddizione 1,3-dipolare. Condensazione di nitro composti primari con dipolarofili catalizzata da basi organiche. SCI Sez. Toscana Riunione Scientifica. Firenze 18 dicembre **2006**. Book of Abstracts, 33.

- 2) **E. Trogu**, L. Cecchi, F. Machetti, F. De Sarlo. Isossazoline e isossazoli via cicloaddizione 1,3-dipolare. Condensazione di nitro composti primari con dipolarofili catalizzata da basi organiche. Congresso della Società Chimica Italiana TUMA. Assisi. Settembre **2007**. Book of Abstracts 15.
- 3) L. Cecchi, **E. Trogu**, F. Machetti, F. De Sarlo. Catalyzed Condensation of Primary Nitro Compounds with Dipolarophiles to Isoxazole Derivatives. The 11th RSC-SCI Joint Meeting on Heterocyclic Chemistry. Villa Marigola, Lerici, 8-11 Maggio **2008**. Book of abstracts, O8.
- 4) **E. Trogu**, L. Cecchi, F. Machetti, F. De Sarlo. Reazione del nitroacetato di etile con alcheni elettron-poveri: competizione fra addizione di Michael e condensazione a derivati isossazolici. XXVI Convegno interregionale TUMA 2008. L'aquila 23 - 25 giugno **2008**; Book of Abstracts, 41.
- 5) L. Cecchi, **E. Trogu**, F. Machetti, F. De Sarlo. 4,5-Dihydroisoxazole by condensation of primary nitro compound with dipolarophiles under organic and copper catalysis. VIII Congresso del gruppo interdivisionale di chimica organometallica Co.G.I.C.O. **2008**. Perugia 25-28 giugno 2008, Book of abstracts, O39.
- 6) **E. Trogu**, F. De Sarlo, F. Machetti, Competizione tra Addizione di Michael e ciclo addizione-condensazione nella reazione tra Nitroacetato di etile ed olefine elettron-povere. XXXIV "A.Corbella" Summer School , 22-26 Giugno 2009, Gargnano (BS), Book of Abstract O20.
- 7) F. Machetti, **E. Trogu**, F. De Sarlo, Nitroacetato di etile e olefine elettron-povere: competizione tra addizione di Michael e cicloaddizione-condensazione. XIII Convegno Nazionale sulle Reazioni Pericicliche - Pavia 17-18 settembre **2009**, Book of Abstract, 22-23.

8) L. Cecchi, F. De Sarlo, L. Guideri, F. Machetti, F. Ponticelli, **E. Trogu**, Condensazione catalitica fra nitrocomposti primari e dipolarofili con metilene attivato. Sintesi di derivati isossazolici e di furossani. XIII Convegno Nazionale sulle Reazioni Pericicliche - Pavia 17-18 settembre **2009**, Book of Abstract, 40.

9) **E. Trogu**, L. Cecchi, F. De Sarlo, L. Guideri, F. Ponticelli, F. Machetti, Sintesi catalitica di derivati isossazolici e di furossani via condensazione di nitrocomposti primari con se stessi e con dipolarofili con metilene attivato, XXVIII Congresso Interregionale TUMA 2009, 20-22 Settembre 2009, Tirrenia (PI).

Index

Abstract	11
Riassunto	14
Chapter 1	
1. Introduction	19
1.1. Importance of isoxazoles and their derivatives	19
1.1.1. A new strategy for the synthesis of isoxazole derivatives from primary nitro compounds and dipolarophiles	20
Chapter 2	
2. Base-catalysed condensation of primary nitro compounds with dipolarophiles	29
2.1. Introduction	29
2.2. Results and discussion	31
2.2.1. Conclusions: mechanism of reaction as a catalytic cycle	42
2.3. Experimental section	43
Chapter 3	
3. Michael Addition versus Cycloaddition-Condensation of Ethyl Nitroacetate with Electron-deficient Olefins	59
3.1. Introduction	59
3.2. Results and discussion	62
3.2.1. The use of Copper salt	68
3.3. Synthetic opportunities	71
3.4. Other Dipolarophiles less or differently reactive	74
3.5. Conclusion	77
3.6. Experimental Section	78

Chapter 4

4. An asymmetric approach to 1,3-dipolar cycloaddition.....	99
4.1. Introduction.....	99
4.1.1. Cycloadditions of Nitrile Oxide	100
4.1.2. Nitrile Oxide Cycloadditions with chiral dipolarophiles	102
4.1.3. Cycloadditions of Nitrile Oxide with achiral olefins bearing chiral auxiliaries.....	103
4.1.4. Cycloadditions of Nitrile Oxides with achiral dipolarophiles with chiral metal chelates.....	104
4.1.3.1. Bis(Oxazoline) catalysts.....	108
4.2. Results and Discussion	114
4.2.1. Reactions in presence of a catalytic amount of Copper (II) salts	122
4.2.2. Reactions with different ratio Dipole/Dipolarophile.....	127
4.2.4. Reactions in the presence of a chiral ligand	129
4.3. Diastereoselectivity	130
4.3.1. The use of a chiral nitro compound.....	130
4.3.2. The use of a racemic dipolarophile.....	133
4.4. Conclusions	138
4.5. Experimental section.....	138

Chapter 5

5. Base and Copper Catalysed Condensation of Primary Activated Nitro Compounds with Active Methylene Compounds.....	157
5.1. Introduction.....	157
5.2. Results and Discussion	160
5.3. Conclusions	169
5.4. Experimental section.....	169

Chapter 6

6. “In Water” and “On Water” Condensations	185
6.1. Introduction.....	185
6.2. Results and discussion.....	186
6.2.1. The sole base catalyses.....	189
6.2.2. The role of the base.....	189
6.2.3. Effect of water on enantioselectivity	189
6.3. Conclusions	186
6.4. Experimental Section	186

Appendix	203
-----------------------	------------

Compound List	219
----------------------------	------------

Abstract

The great interest associated with isoxazoles and their derivatives is based on their versatility as synthetic building blocks. One of the most important strategies for obtaining these heterocycles is from nitrile oxides by cycloaddition with dipolarophiles.¹ Primary nitro compounds are extensively used as starting materials for this synthesis, as they are converted into nitrile oxides by various dehydrating agents.²

Recently a new catalysed approach using primary nitro compounds and dipolarophiles to obtain cycloadducts without need of dehydrating reagents was developed.³ Condensation takes place under catalysis with a suitable base⁴ or with a combination of base and copper (II) salt.⁵ The mechanism and applications to different substrates were developed, to obtain polifunctional isoxazoles (Scheme 2-1).

The procedure was then applied to electron-poor olefins and the conditions affecting the competition between Michael addition and cycloaddition were studied, in order to establish how the catalyst may influence the results. It was demonstrated that a selective process was possible, modulating the catalytic system (Scheme 1).⁶

Kinetic profiles for the two processes show that the cycloaddition-condensation to cycloadduct occurs with a longer induction time (white

¹ K. B. G. Torsell, *Nitrile Oxides, Nitrones and Nitronates in Organic Synthesis*; VCH: Weinheim, **1988**.

² T. Mukaiyama, T. Hoshino *J. Am. Chem. Soc.* **1960**, 82, 5339 – 5342.

³ L. Cecchi, F. De Sarlo, F. Machetti, *Eur. J. Org. Chem.* **2006**, 4852 – 4860.

⁴ F. Machetti, L. Cecchi, E. Trogu, F. De Sarlo *Eur. J. Org. Chem.*, **2007**, 4352–4359.

⁵ L. Cecchi, F. De Sarlo, F. Machetti *Chem. Eur. J.* **2008**, 7903 – 7912.

⁶ E. Trogu, F. De Sarlo, F. Machetti *Chem. Eur. J.* **2009**, 7940 – 7948.

circles) which dramatically decreases upon addition of a copper salt to the catalytic system (solid circles) (Figure 1).

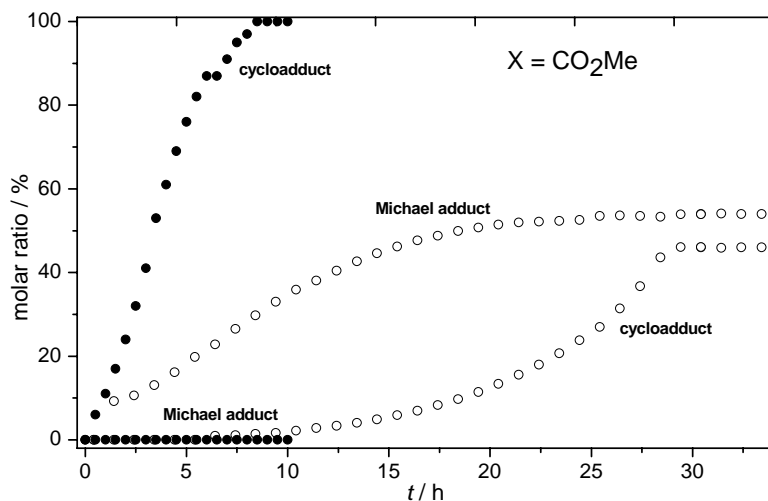
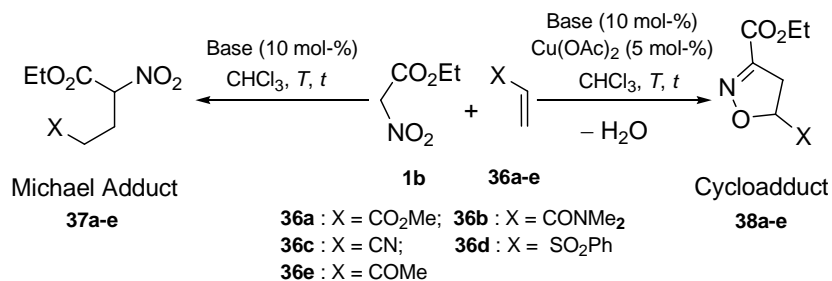


Figure 1.

This procedure was then extended to 1,3-dicarbonyl compounds in order to obtain polifunctional isoxazoles (Table 5-2). Activated nitro compounds, in absence of dipolarophiles, were shown to convert to furoxans (nitrile oxides dimers). The nitro ketone, benzoyl nitromethane, in its enolic form, behaves as a dipolarophile like other

enolizable compounds, leading beside the furoxan to an isomer identified as 3-benzoyl-4-nitro-5-phenylisoxazole (Scheme 5-1).⁷

This method is the first general catalytic process of condensation between nitro compounds and dipolarophiles, that uses cheap and commercially available catalysts and appears to be more attractive for the environment, compared to the protocols commonly in use so far, where stoichiometric amounts of highly polluting reagents are required.

This catalytic method takes place even using water as solvent. A study of the influence of water on the reaction has shown that excellent results are obtained from nitroacetic esters or amides, in conditions that are even more acceptable for the environment.

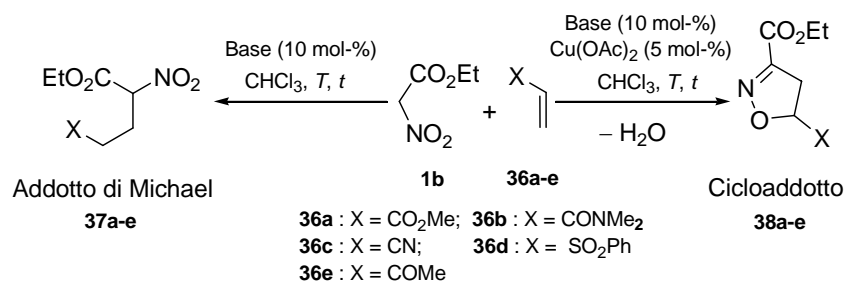
A systematic study on an asymmetric approach of the process was also carried out: many chiral bases and ligands for the metal were used and an appropriate analytical method was tuned. Only little ee % was obtained so far and the study is still in progress.

⁷ E. Trogu, L. Cecchi, F. De Sarlo, L. Guideri, F. Ponticelli, F. Machetti, *Eur. J. Org. Chem.*, **2009**, 5971-5978.

Riassunto

L'interesse verso gli isossazoli deriva dalla loro particolare e versatile reattività. Questa peculiarità ha promosso il loro uso come intermedi sintetici. Una delle più importanti metodiche per la sintesi di questi eterocicli prevede l'utilizzo di una reazione di cicloaddizione tra nitrilossidi e olefine o alchini.¹ I nitrocomposti primari sono stati utilizzati come materiale di partenza per questa sintesi in quanto possono essere convertiti nei corrispondenti nitrilossidi per azione di agenti disidratanti.² Recentemente è stato sviluppato un nuovo metodo catalitico che utilizza come substrati nitrocomposti e dipolarofili ma evita l'uso degli agenti disidratanti.³ La condensazione avviene per azione di una adatta base organica⁴ o attraverso la combinazione di una base con un sale di rame.⁵ Con questo metodo sono stati ottenuti isossazoli funzionalizzati (Scheme 2-1), il meccanismo della reazione è stato inoltre in parte chiarito.

Questa procedura è stata utilizzata con substrati costituiti da olefine elettron-povere. Sono state studiate le condizioni sperimentali che regolano la competizione tra la reazione del nitronato, derivato dal nitrocomposto, che porta o alla cicloaddizione o all'addizione di Michael (Schema 2).⁶ È stato dimostrato che il processo può essere indirizzato selettivamente verso uno dei due prodotti attraverso il controllo della tipologia di catalizzatore. I profili cinetici dei due processi mostrano che la cicloaddizione-condensazione inizia dopo un lungo tempo di induzione (cerchi vuoti). Questo tempo di induzione diminuisce notevolmente all'aggiunta di sali di rame(II) (cerchi pieni) (Figura 2).



Schema 2.

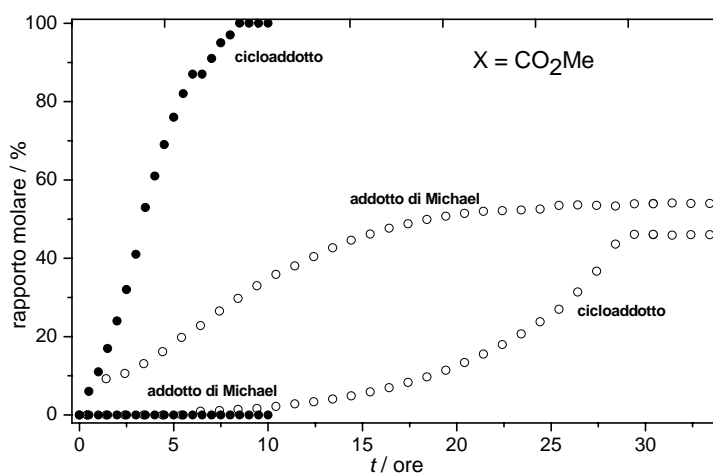


Figura 2.

Applicando questa procedura a composti 1,3-dicarbonilici sono stati ottenuti 5-metilossazoli variamente funzionalizzati (Table 5-2). I nitrocomposti attivati in assenza di dipolarofilo danno reazione di autocondensazione per dare il corrispondente furossano (dimero del nitrilossido). Nitrochetoni come ad esempio benzoinnitrometano, nella loro forma enolica si comportano come dipolarofili e reagendo con il dipolo da loro derivato, formando il corrispondente cicloaddotto che nel caso del benzoinnitrometano corrisponde al 3-benzol-4-nitro-5-fenilisossazolo (Scheme 5-1).⁷ Questo metodo rappresenta il primo processo catalitico di condensazione tra nitrocomposti e dipolarofili, usa

un catalizzatore economico e di facile reperibilità commerciale e si presenta con caratteristiche migliorative, dal punto di vista ambientale, rispetto ad altre procedure sintetiche. Queste ultime usano infatti quantità stechiometriche di reagenti altamente inquinanti. Questo metodo catalitico funziona anche in ambiente acquoso. Lo studio dell'influenza dell'acqua sulla reazione ha fornito sufficienti indicazioni a riguardo dell'eccellente compatibilità dei substrati e dei catalizzatori con questo solvente sia in termini di rese che, soprattutto, di velocità di reazione. Allo stato attuale la procedura è stata saggiata con esteri nitroacetici e le corrispondenti metil ammidi. Uno studio sistematico del processo in termini di enantioselettività è stato condotto: sono state utilizzate molte basi e leganti per il metallo mettendo a punto un adeguato metodo analitico per la determinazione dell'eccesso enantiomerico. Al momento sono stati ottenuti valori di eccesso enantiomerico modesti. Il lavoro su questo argomento è ancora in corso.

Chapter 1

1. Introduction

1.1. Importance of isoxazoles and their derivatives

Isoxazoles, isoxazolines, and isoxazolidines are five-membered heterocyclic systems with one oxygen and one nitrogen atom at adjacent positions.

The chemistry of isoxazole is associated with Ludwig Claisen, who recognized the cyclic structure of 3-methyl-5-phenylisoxazole in 1888, obtained by Ceresole in 1884 from hydroxylamine and benzoylacetone.⁸ A very significant contribution to the development of isoxazole chemistry came between 1930–1946 from Quilico's studies on the synthesis of ring system from nitrile oxides and unsaturated compounds.⁹ The great interest associated with this class of compounds

⁸ a) L. Claisen and O. Lowman *Chem. Ber.*, **1888**, 21, 1149; b) M. Ceresole *Chem. Ber.*, **1884**, 17, 812.

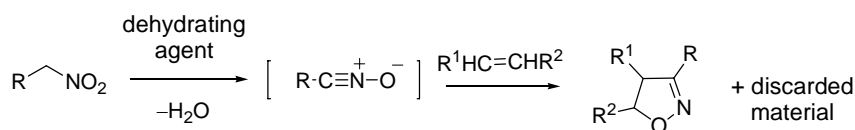
⁹ a) A. Quilico and M. Freri *Gazz. Chim. Ital.*, **1930**, 60, 172.; b) A. Quilico, G. Stagno d'Alcontres and P. Grünanger *Nature*, **1950**, 166, 226.

is based on their versatility as synthetic building blocks: their latent functionalities as enaminones, 1,3-dicarbonyl compounds, γ -amino alcohols, and β -hydroxy nitriles have been widely exploited for the synthesis of other heterocycles and complex molecules. Moreover, many derivatives have applications in various fields such as agriculture, industry and medicine. In particular, the wide spectrum of biological activities characteristic of these systems, including antithrombotic, platelet-activating factor (PAF) antagonist, hypolipidemic, nootropic, immunomodulator, antiviral, antiobesity, and central nervous system (CNS) modulation, may be ascribed to the easy cleavage of the N—O bond with formation of more reactive species.¹⁰

1.1.1. A new strategy for the synthesis of isoxazole derivatives from primary nitro compounds and dipolarophiles

One of the most important strategies for obtaining isoxazole and their derivatives is from cycloaddition between nitrile oxide and dipolarophiles. Primary nitro compounds are extensively used as starting materials for this synthesis. Thus, on treatment with various dehydrating agents such as isocyanates, organic chlorides, organic anhydrides often in the presence of a base, a nitrile oxide intermediate forms and, when added to the dipolarophile, yields the isoxazole or isoxazoline products, besides discarded material derived from the reagent employed (Scheme 1-1).

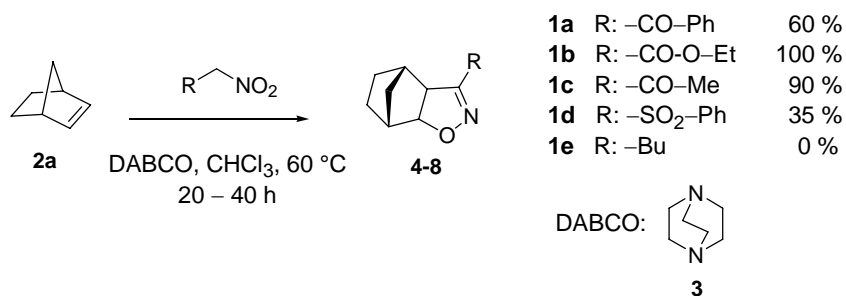
¹⁰ D. Giomi, F. M. Cordero and F. Machetti in: *Comprehensive Heterocyclic Chemistry III* (Eds.: A. Katritzky, C. Ramsden, E. Scriven, R. Taylor), Elsevier, 2008, p. 367.



Scheme 1-1.

Recently a new approach based on synthesis using primary nitro compounds and dipolarophile to obtain cycloadducts without the need of dehydrating reagents was developed.³ Condensation takes place under catalysis with a suitable base for activated nitro compounds⁴ or with metal salts for primary nitroalkanes.⁵

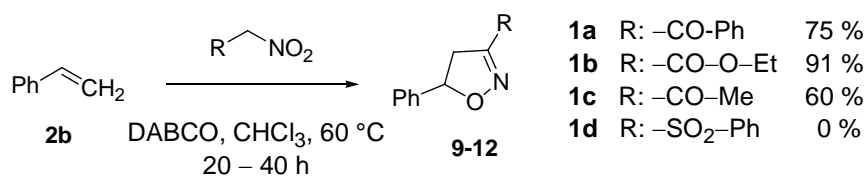
In 2003 it was discovered in the Department of Organic Chemistry at the University of Florence that “activated” nitro compounds like ethyl nitroacetate (**1b**) reacted with norbornene (**2a**) (Scheme 1-2) or styrene (**2b**) (Scheme 1-3) in the presence of a tertiary base like DABCO (**3**) to give the corresponding isoxazolines as formal cycloadducts from nitrile oxide species.



Scheme 1-2.

Since, other experiments have been carried out to expand the application to other nitro compounds and dipolarophiles. It was found that the synthetic procedure leads efficiently to isoxazoline derivatives

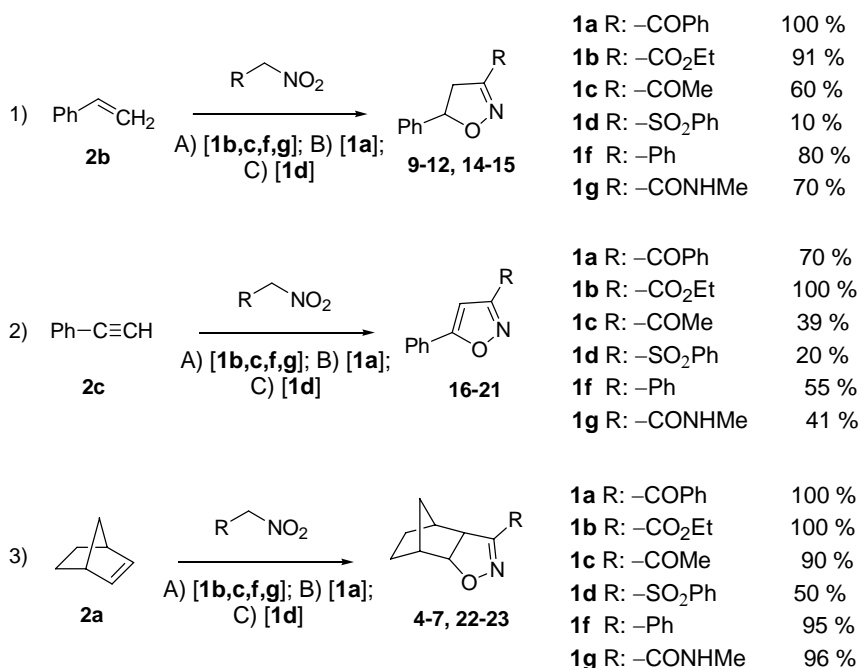
and, most importantly, this occurs without any need for a dehydrating reagent (Scheme 1-3).¹¹



Scheme 1-3.

The role of the base in this process was then examined, screening a wide range of primary, secondary and tertiary aliphatic or azaheteroaromatic amines with one or more basic centres, several nitro compounds and dipolarophiles (alkenes and alkynes) and it turned out that the first base used, DABCO (**3**), was one of the most efficient base along with N-methylimidazole (**13**) and a few others (Scheme 1-4).

¹¹ L. Cecchi, F. De Sarlo, F. Machetti *Tetrahedron Lett.* **2005**, 46, 7877-7879.



Scheme 1-4. A) DABCO, CHCl₃, 60 °C, 20 - 40 h; B) NMI, CHCl₃, 60 °C, 20 - 40 h; C) DABCO, EtOH 60 °C, 80 h.

The efficiency of the base has been formed to be related rather than to its strength, to its ability to establish H-bonded ion pairs with (intermediates) adducts.³

As reported in this thesis this process has been optimized for organocatalysis, lowering the amount of base to less than five mol% with respect to the dipolarophile. In these conditions different functional groups (such as hydroxyl or nitro groups) are well tolerated with the sole limitation for unactivated nitro compounds; in fact the reaction fails using nitroalkanes.⁴

Therefore, a new catalytic system based on a copper salt combined with a base was developed. The catalytic effect of copper on the condensation of primary nitro compounds with dipolarophile to give isoxazole derivatives was highlighted by plotting the progress of reaction of ethyl

nitroacetate (**1b**) and styrene (**2b**): the nitro compound reacts faster under copper (II) catalysis than under organic catalysis by tertiary amines (Figure 1-1). The catalytic effect of Cu (II) salts is even more important with nitroalkanes: for example nitropentane (**1i**) reacts only under copper catalysis.

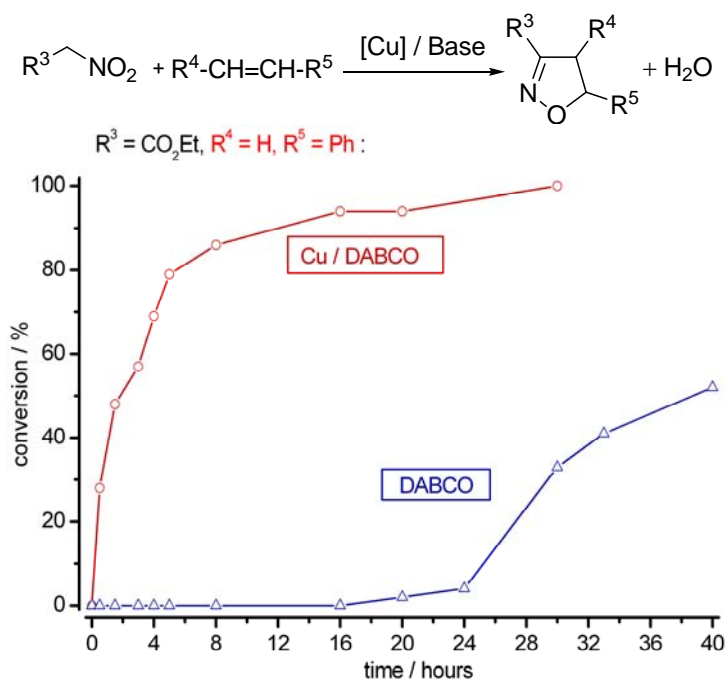


Figure 1-1. The catalytic effect of CuII salts: ethyl nitroacetate (**1b**) reacts faster with copper(II) catalysis (reddish curve) than with organic catalysis by tertiary amines (blue curve).

This method is the first general catalytic process of condensation between nitro compounds and alkene or alkyne dipolarophiles. The process uses a cheap and commercially available catalyst and does not require the exclusion of oxygen or the use of meticulous dried solvents to protect the catalytic system.

This catalytic method takes place even using water as solvent. A study of the influence of water on the reaction has shown that excellent results

are obtained from nitroacetic esters or amides, in conditions that are even more acceptable for the environment.

Chapter 2

2. Base-catalysed condensation of primary nitro compounds with dipolarophiles

2.1. Introduction

The importance of isoxazole derivatives has stimulated the development of many methods for their synthesis,^{12,13} including the use of primary nitro compounds as precursors of 1,3-dipoles, yielding isoxazoles and

¹² For latent functionality in isoxazoles and isoxazolines see: a) V. Jäger, P. A. Colinas in *Synthetic Applications of 1,3-Dipolar Cycloaddition Chemistry Toward Heterocycles and Natural Products*, pag. 416, A. Padwa, W. H. Pearson Eds., Wiley: New Jersey, **2003**. b) A. A. Akhrem, F. A. Lakhvich, V. A. Khripach *Chem. Heterocycl. Compd.* **1981**, *17*, 853 – 868. [*Khim. Geterotsikl. Soedin.*, **1981**, *17*, 1155 – 1173]. c) D. Lednicer, Latent Functionality in *Organic Synthesis Adv. Org. Chem.* **1972**, *8*, 17.

¹³ For the use of heterocycles in organic synthesis see: A. I. Meyers, *Heterocycles in Organic Synthesis*, Wiley, New York, **1974**.

isoxazolines by 1,3-dipolar cycloaddition (1,3-DC).¹⁴ By this retrosynthetic approach, alkyl-, acyl- or silylnitronates or nitrile oxides can be used as 1,3-dipoles depending on the reagents employed. Acidic dehydrating agents¹⁵ have been utilized at high temperatures, while acylating or alkylating reagents have been utilised with a base.¹⁶ These methods have a negative environmental impact and in addition suffer from drawbacks arising from the dipole (dimerisation or polymerisation) or the dehydrating agent (byproducts) and limitations derived from interference by other functional groups present in the reagents. Therefore, product isolation and purification is often complicated by these contaminants and consequently yields may be low. As far as the synthesis from primary nitro compounds via nitrile oxides is concerned, since the presence of the loss of water is irreversible, a dehydrating reagent appears not to be an essential component of the reaction. Thus, various reagents (nitro compound, base and dipolarophile) and solvents were investigated in order to establish reaction flexibility. Recently the dehydration of "activated" primary nitro compounds, including phenylnitromethane, has been reported to be achieved with 1,4-diazabicyclo[2.2.2]octane (DABCO) (**3**) or other bases, provided dipolarophiles are present, thus leading directly to the

¹⁴ a) Caramella, P.; Grünanger, P. In *1,3-Dipolar Cycloaddition Chemistry*, A. Padwa, Ed., Wiley: New York, **1984**. b) K. B. G. Torsell, *Nitrile Oxides, Nitrones and Nitronates in Organic Synthesis*; VCH: Weinheim, **1988**. c) V. Jäger, P. A. Colinas in *Synthetic Applications of 1,3-Dipolar Cycloaddition Chemistry Toward Heterocycles and Natural Products*, pag. 368, A. Padwa, W. H. Pearson Eds., Wiley: New Jersey, **2003**.

¹⁵ T. Shimizu, Y. Hayashi, K. Teramura *Bull. Chem. Soc. Jpn.* **1984**, *57*, 2531 – 2534.

¹⁶ a) T. Mukaiyama, T. Hoshino *J. Am. Chem. Soc.* **1960**, *82*, 5339 – 5342. b) Y. Basel, A. Hassner *Synthesis* **1997**, 309 – 312. c) G. Giacomelli, L. De Luca, A. Porcheddu *Tetrahedron*, **2003**, *59*, 5437 – 5440. d) E. J. Kantorowski, S. P. Brown, M. J. Kurth *J. Org. Chem.*, **1998**, *63*, 5272–5274. e) T. Shimizu, Y. Hayashi, H. Shibafuchi, K. Teramura *Bull. Chem. Soc. Jpn.* **1986**, *59*, 2827–2831. f) N. Maugein, A. Wagner, C. Mioskowski *Tetrahedron Lett.* **1997**, *38*, 1547–1550.

expected cycloadducts.^{3,11,17} No dehydrating agents are required: the reaction proceeds even in the presence of water, which is a reaction product. A major drawback of water, combined with the presence of the base, is the facile decomposition of the activated nitro compounds (**1a-b**, **1f-h**). The mechanism proposed for the reaction implies that the base behaves as a catalyst. Therefore how the reaction is affected when the amount of base is lowered to catalytic quantities has been investigated.^{11,18,19}

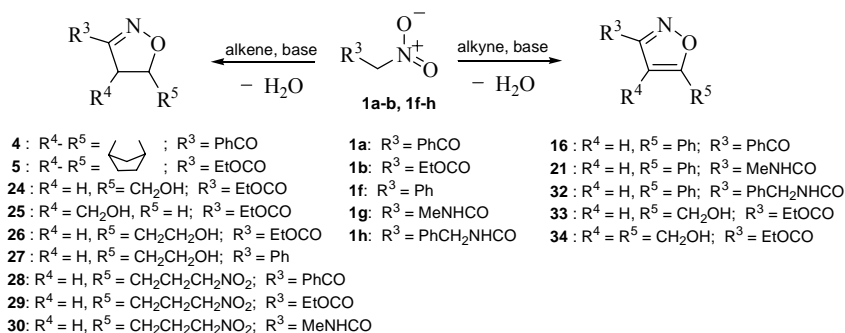
2.2. Results and discussion

The base-catalysed reactions are illustrated in Scheme 2-1: dipolarophiles bearing functional groups such as OH or NO₂ have been included with the aim of illustrating the substrate scope of the method.

¹⁷ L. Cecchi, F. De Sarlo, C. Faggi, F. Machetti *Eur. J. Org. Chem.* **2006**, 3016 – 3020.

¹⁸ For examples of tertiary amines mediated transformations see: S.-K. Tian, Y. Chen, J. Hang, L. Tang, P. McDaid, L. Deng *Acc. Chem. Res.* **2004**, *37*, 621 – 631.

¹⁹ Morita-Baylis-Hillman reaction: a) A. B. Baylis, M. E. D. Hillman *German Patent* **1972**, 2155113, *Chem. Abstr.* **1972**, *77*, 34174q. b) D. Basavaiah, A. J. Rao, T. Satyanarayana *Chem. Rev.* **2003**, *103*, 811 – 892. c) Stille coupling: J.-H. Li, Y. Liang, D.-P. Wang, W.-J. Liu, Y.-X. Xie, D.-L. Yin *J. Org. Chem.* **2005**, *70*, 2832 – 2834. d) Suzuki-Miyaura Cross-Coupling Reaction: J.-H. Li, W.-J. Liu *Org. Lett.* **2004**, *6*, 2809 – 2811. e) Heck reaction: cyanation of ketons: S.-K. Tian, R. Hong, L. Deng *J. Am. Chem. Soc.* **2003**, *125*, 9900 – 9901. f) Ring opening of aziridines: J. Wu, X. Sun, Y. Li *Eur. J. Org. Chem.* **2005**, 4271 – 4275. g) Self-assembly of metalloporphyrins: P. Ballester, A. Costa, A. M. Castilla, P. M. Deyà, A. Frontera, R. M. Gomila, C. A. Hunter *Chem. Eur. J.* **2005**, *11*, 2196 – 2206.

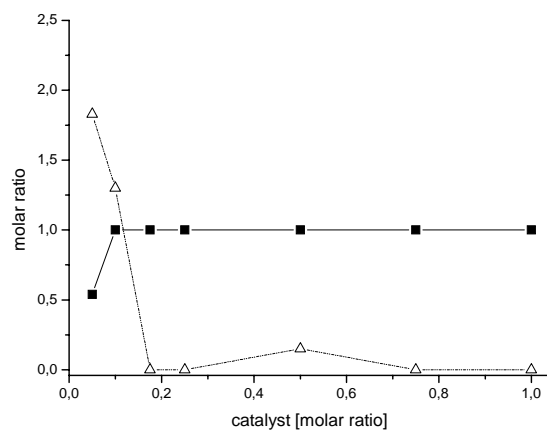
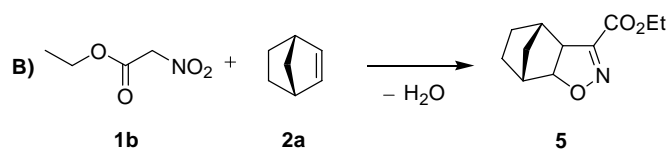
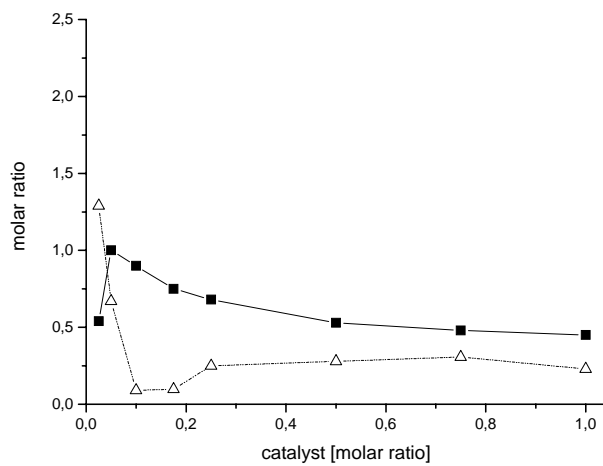
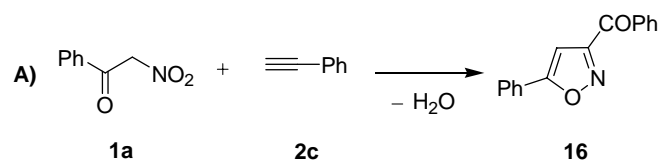


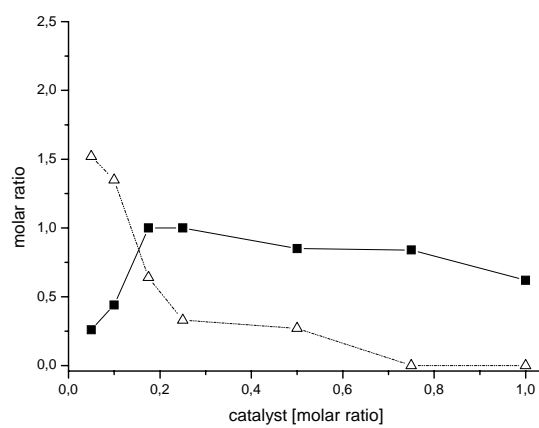
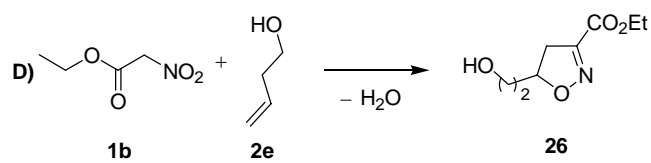
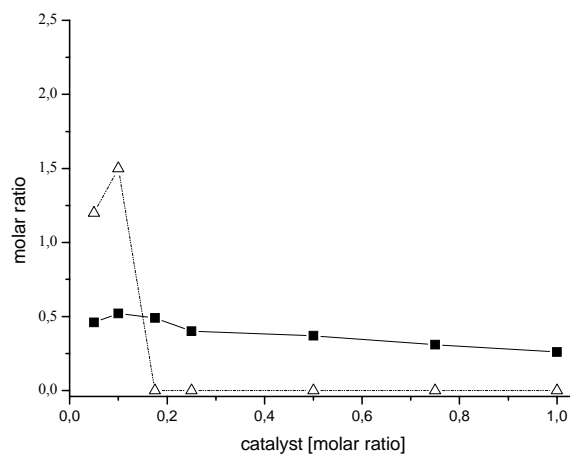
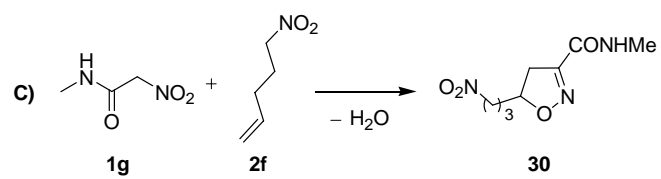
Scheme 2-1. Synthetic approach and nitro compounds/ dipolarophiles used in this study.

Several reactions were chosen as models for this study (Figure 2-1, **A-F**). These were carried out under the usual conditions: nitro compounds **1a-b** and **1f-h** + dipolarophile + base (molar ratios = 2.5: 1: variable, ranging from 0.025 to 1) at 60 °C in chloroform except for one example carried out in ethanol (**26**, Figure 2-1, **E**). The base employed was *N*-methylimidazole (NMI, **13**) for the reaction leading to the adduct **31** in order to avoid a side-reaction leading to furazan derivatives from the reagents benzylnitromethane (**1a**) and the dipolarophile in the molar ratio 2:1.¹⁷ In the other reactions (Figure 2-1, **B-D**), DABCO (**3**) was used as the base. For comparison, the reaction leading to **26** was also studied with 4-(dimethylamino)pyridine (4-DMAP, **32**) as the base (Figure 2-1, **F**). After a pre-arranged time (see Experimental section for details), the reacting mixtures were analysed by ¹H NMR spectroscopy and the molar ratios between the product, nitro compound and dipolarophile were evaluated relative to the dipolarophile (residual + amount converted into adduct). For each molar ratio of base (with respect to the dipolarophile employed) the molar ratios of the dipolarophile converted into the product and the residual nitro compound were reported in Figure 2-1, **A-F**, respectively as solid squares and white triangles. The

presence of the base (with the water produced in the reaction) causes considerable decomposition²⁰ of the nitro compounds (**1a-b** and **1g**): in fact, the total amount (residual + converted into adduct) detected at the end is less than that engaged in the reaction (2.5 molar fraction with respect to the dipolarophile). However, as the amount of base is lowered, the decomposition of the nitro compounds is less severe: some minor variations depend on which base, nitro compound or solvent are involved. The conversion into products observed after the established time results from a balance between the reaction rate (increasing with the molar ratio of the base) and the stability of the starting nitro compound (decreasing as the molar ratio of the base increases). When the conversion is incomplete, a longer reaction time might ensure an increased yield only if some nitro compound is still present (e.g., **30**, at a molar ratio of 0.1 DABCO (**3**), Figure 2-1, C): the excess of the nitro compound (2.5 times the dipolarophile) employed in these experiments was aimed at enhancing the conversion of the dipolarophile into the product. The use of ethanol as the solvent gave good results with ethyl nitroacetate (**1b**) and phenylnitromethane (**1f**), whereas the other nitro compounds were more rapidly cleaved.

²⁰ The decomposition of nitro compounds **1a-b** and **1f-h** under our experimental conditions has not been examined in detail. However, mainly benzoic acid from benzoylnitromethane (**1a**) and ethanol from ethyl nitroacetate (**1b**) have been identified by ¹H NMR, beside minor amounts of nitromethane.





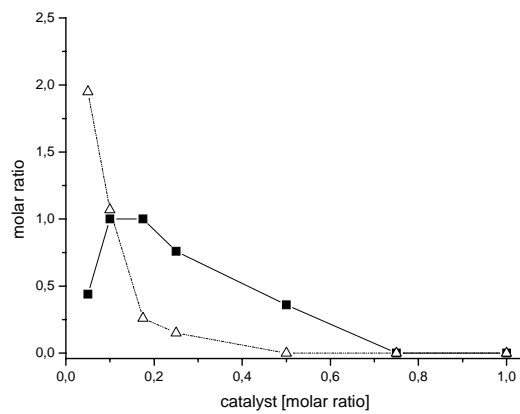
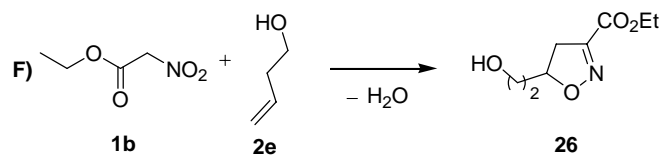
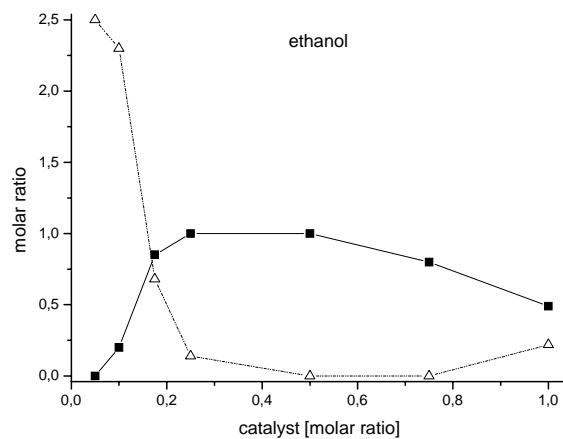
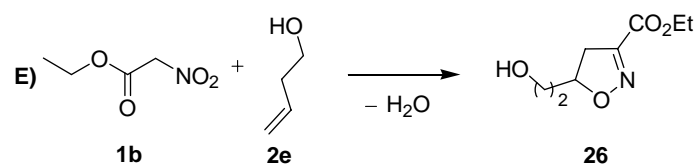


Figure 2-1. Condensation of nitro compounds with dipolarophiles catalysed by organic bases. Effect of the base/dipolarophile ratio on the conversion of the dipolarophile into the cycloadduct and on the decomposition of the nitro

compound (**A–D**, **F** in chloroform, **E** in ethanol). The molar ratios of the product (solid squares) and of the residual nitro compound (white triangles) (with respect to the dipolarophile and detected by ^1H NMR spectroscopy after the established time) are reported as a function of the molar ratio of the base. Nitro compound (0.75 M) + dipolarophile (0.30 M) at 60 °C: (**A**)–(**D**) and (**F**) in chloroform, (**E**) in ethanol. **A**) NMI, 20 h; **B**) DABCO, 40 h; **C**) DABCO, 20 h; **D**) DABCO, 40 h; **E**) DABCO, 40 h; **F**) 4-DMAP, 40 h.

The reaction conditions were selected on the basis of the above results and the compounds prepared are reported in Table 2-1. Compared with previous results (when available) the yields are higher [products **5** (83 %),²¹ **16** (34 %),²² **34** (61 %),²³ **27** (54%)²⁴ and **26** (70%)²⁵] or similar [products **22** (98%)²⁶ and **21** (85%)²⁷].

All the reactions were carried out in chloroform except for that of 2-butyne-1,4-diol (**2h**) which was carried out in ethanol (entries 20 and 21) because of the low solubility of this dipolarophile in chloroform. From dipolarophiles containing monosubstituted multiple bonds, only the 5-substituted regioisomers were detected by ^1H NMR spectroscopy. However, in the reaction of ethyl nitroacetate (**1b**) with allyl alcohol (**2d**), carried out on a larger scale, besides the 5-hydroxymethyl regioisomer **24**, a minor amount of the 4-hydroxymethyl regioisomer **25** was detected and isolated by repeated chromatography. For the reactions of benzonitromethane (**1a**, entries 10 and 13) *N*-

²¹ P. Caldirola, M. De Amici, C. De Micheli, P. A. Wade, D. T. Price, J. F. Boreznak *Tetrahedron* **1986**, *42*, 5267 – 5272.

²² R. Warsinsky, E. Steckhan *J. Chem. Soc. Perkin Trans. I*, **1994**, 2027–2037.

²³ K. S. Lee, Y. K. Kang, K. H. Yoo, D. C. Kim, K. J. Shin, Y.-S. Paikb, D. J. Kima *Biorg. Med. Chem. Lett.* **2005**, *15*, 231 – 234.

²⁴ M. J. Fray, E. J. Thomas *Tetrahedron* **1984**, *40*, 673 – 680.

²⁵ W. J. Pitts, J. Wityak, J. M. Smallheer, A. E. Tobin, J. W. Jetter, J. S. Buynitsky, P. P. Harlow, K. A. Solomon, M. H. Corjay, S. A. Mousa, R. R. Wexler, P. K. Jadhav *J. Med. Chem.* **2000**, *43*, 27–40.

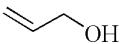
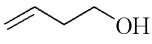
²⁶ G. K. Tranmer, W. Tam *Org. Lett.* **2002**, *23*, 4101 – 4104.

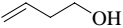

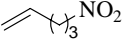
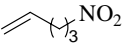
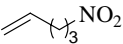



²⁷ N. Nishiwaki, T. Uehara, N. Asaka, Y. Tohda, M. Ariga, S. Kanemasa *Tetrahedron Lett.* **1998**, *39*, 4851 – 4852.

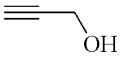
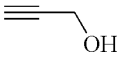
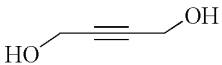
methylimidazole (NMI, **13**) was employed for the above-mentioned reason, with excellent results. The reactions of benzoynitromethane (**1a**) and of nitroacetamides (**1g** and **1h**) could not be carried out in ethanol as cleavage is easier than in chloroform. However, reactions of ethyl nitroacetate (**1b**), leading to **24**, **26**, **34** and **35** (entries 4, 7, 19 and 20), and of phenylnitromethane (**1f**), leading to **27** (entry 9), could be profitably performed in ethanol (Figure 2-1, E): the reaction temperature can be raised to 80 °C with considerable reduction of reaction time and enhancement of conversion (entries 4, 9 and 19).

The presence of a hydroxy group in the dipolarophile does not interfere with the reaction (100% conversion observed: entries 4, 7, 9 and 19). The reduced yield of **34** observed in CHCl₃, in spite of a quantitative conversion (entry 17), is ascribed to partial intermolecular transesterification: the product is protected when ethanol is the solvent (entry 19). The catalytic use of 4-(dimethylamino)pyridine (**32**) (see Figure 2-1, F), applied in two cases (Table 2-1, entries 6 and 21), gave the same results as those obtained with DABCO (**3**), but required a lower concentration of the base (entry 5 vs. entry 6), while for the slow reaction with 2-butyne-1,4-diol (**2h**) no improvement was observed (entry 21). The preparation of **24** from ethyl nitroacetate (**1b**) and allyl alcohol (**2d**) in ethanol was repeated on a larger scale (0.349 g of dipolarophile converted) with no significant difference with respect to the result reported in Table 2-1 (entry 4), but the minor regioisomer **25** was identified.

Table 2-1. ^[a] Base catalysed synthesis of isoxazolines and isoxazoles by condensation of primary nitro compounds and dipolarophiles.

		$R^3-CH_2-NO_2$ + dipolarophile		base (mol%) , solvent, T (°C), t (h)					
Entry	R ³	Dipolarophile	Solvent	T (°C)	Base (mol %) ^[e]	t (h)	Prod.	% ^[b]	% ^[c]
1	EtOCO	Norbornene	CHCl ₃	60	DABCO (10)	40	5	100	100
2	Ph	Norbornene	CHCl ₃	60	DABCO (10)	72	22	100	98
3	EtOCO		CHCl ₃	60	DABCO	60	24	60	-
4			EtOH	80	DABCO	37		100	95
5	EtOCO		CHCl ₃	60	DABCO (17.5)	40	26	100	97
6					4-DMAP	40		100	96
7			EtOH	80	DABCO (17.5)	16	100	97	

Entry	R ³	Dipolarophile	Solvent	T (°C)	Base (mol %) ^[e]	t (h)	Prod.	% ^[b]	% ^[c]
8	Ph		CHCl ₃	60	DABCO	40	27	61	49
9	Ph		EtOH	80	(10)			100	94
10	PhCO		CHCl ₃	60	NMI (5)	72	28	100	83
11	EtOCO		CHCl ₃	60	DABCO (10)	72	29	100	98
12	MeNHCO		CHCl ₃	60	DABCO (5)	120	30	100	88
13	PhCO	Ph— 	CHCl ₃	60	NMI (5)	20	31	100	97
14	MeNHCO	Ph— 	CHCl ₃	60	DABCO (5)	72	21	nd ^[d]	84
15					DABCO (10)			nd ^[d]	75
16	BnNHCO	Ph— 	CHCl ₃	60	DABCO (5)	72	33	97	68

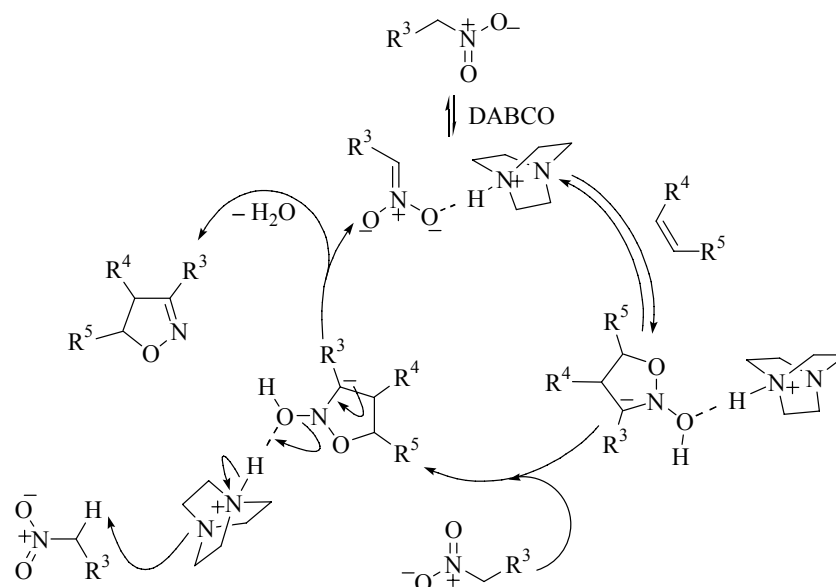
Entry	R ³	Dipolarophile	Solvent	T (°C)	Base (mol %) ^[e]	t (h)	Prod.	% ^[b]	% ^[c]
17			CHCl ₃	60	DABCO	72		100	74
18	EtOCO		EtOH	60	DABCO	72	34	29	-
19				80	(10)			100	98
20	EtOCO		EtOH	80	DABCO (10)	72	35	50	29,46 ^[f]
21					4-DMAP (10)			nd ^[d]	21

[a] See experimental section for details. [b] Conversion of dipolarophile determined by ¹H NMR. [c] Isolated yield determined on analytically pure product and based on dipolarophile. [d] Not determined: signals are not well-resolved in ¹H NMR spectra. [e] Referred to dipolarophile [f] Obtained with 5 equiv of Ethyl nitroacetate instead of 2.5 equiv. in a longer time of 90h.

2.2.1. Conclusions: mechanism of reaction as a catalytic cycle

The illustrated examples unequivocally show that primary activated nitro compounds condense with dipolarophiles to form isoxazole derivatives under organic catalysis by DABCO (**3**) or other suitable N-bases. An attempted rationalisation of the mechanism is depicted in Scheme 2-2: in chloroform the hydrogen-bonded ion pair formed between the nitronate and the protonated base undergoes reversible cycloaddition with the dipolarophile and then the hydrogen-bonded intermediate adduct releases water by reaction with a second molecule of nitro compound to give the product and again the hydrogen-bonded nitronate.

The illustrated catalytic cycle, relevant to a solvent of low polarity such as chloroform, is based on the following evidence. (I) nitro compounds **1a-b** and **1f-g**, having $pK_{\text{HB}} \leq 7$, on mixing with DABCO (**3**) react to give ammonium salts either as separate ions or as hydrogen-bonded complexes depending on the solvent polarity; (II) these nitro compounds are unaffected by dipolarophiles in the absence of a base or other reagents; (III) from nitro compounds and a catalytic amount of base, isoxazoles are produced from alkynes and 4,5-dihydroisoxazoles from alkenes; (IV) changing the base has shown that its efficiency is related to the stability of the hydrogen bond between the nitronate and the protonated base. Indeed, in other solvents the reaction is not favoured when ion separation is caused by highly polar solvents (DMSO, acetonitrile) unless a hydroxy group (ethanol) ensures hydrogen-bonding to the anion.³



Scheme 2-2. Proposed mechanism for catalysed condensation of nitro compounds and dipolarophiles.

2.3. Experimental section

General: Melting points were recorded with a Büchi 510 apparatus and are uncorrected. Chromatographic separations were performed on silica gel 60 (40–6.3 μm) with analytical-grade solvents, driven by a positive pressure of air; R_f values refer to TLC carried out on 25-mm silica gel plates (Merck F254) with the eluent indicated for the column chromatography. For gradient column chromatography R_f values refer to the more polar eluent. ^1H and ^{13}C NMR spectra were recorded with a Mercuryplus 400 spectrometer (operating at 400 MHz for ^1H and 100.58 MHz for ^{13}C). The multiplicities of the ^{13}C NMR signals and assignments were determined by means of HMQC and gHMBC experiments. Chemical shifts were determined relative to the residual solvent peak (CHCl_3 : $\delta = 7.24$ ppm for ^1H NMR and $\delta = 77.0$ ppm for ^{13}C NMR). EI (electron impact) mass spectra (at an ionising voltage of 70 eV) were obtained using a Shimadzu QP5050A quadrupole-based mass spectrometer. Ion

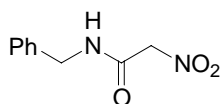
mass/charge ratios (m/z) are reported in atomic mass units followed by the intensities relative to the base peak in parentheses. IR spectra were recorded with a Perkin-Elmer 881 spectrometer. Elemental analyses were obtained with an Elemental Analyser Perkin-Elmer 240C apparatus. Phenylnitromethane (**1f**) and *N*-methyl-2-nitroacetamide (**1g**) were prepared according to reported procedures.³ Commercially available (Lancaster and Aldrich) benzoynitromethane (**1a**) and ethyl nitroacetate (**1b**), were used as supplied. DABCO (**3**), 4-DMAP (**32**) and NMI (**13**) are commercially available and used as supplied. CHCl_3 (ethanol-free) was filtered through a short pad of potassium carbonate just before use. Allyl alcohol (**2d**) and propargyl alcohol (**2g**) were distilled before use. 2-Butyne-1,4-diol (**2h**) was crystallised (AcOEt) before use.

Effect of the Amount of Base on the Conversion of the Dipolarophile (Figure 2-1; A-F):

Different amounts of base were screened in an apparatus in which 6–8 reactions were carried out simultaneously. The base (DABCO, NMI or 4-DMAP), in a variable base/dipolarophile molar ratio (1, 0.75, 0.5, 0.25, 0.175, 0.10, 0.05, 0.025), dipolarophile (0.424 mmol), nitro compound (1.06 mmol) and solvent (chloroform or ethanol, 1.4 mL) were stirred at 60 °C in a sealed tube for the indicated time. For the 0.025 base/dipolarophile molar ratio, twice the amount of reagents and solvent was used. After the requested time, an aliquot portion was withdrawn and diluted with CDCl_3 (0.6 mL). After addition of 4×10^{-3} mL of TFA, the ^1H NMR spectrum was recorded and the conversion (as a molar ratio) was evaluated as follows. Benzoynitromethane (**1a**) and phenylacetylene (**2c**) (Figure 2-1, A): by integrating the 4-H proton signal of the cycloadduct **31** [$\delta = 7.03$ (s) ppm] and the acetylenic proton of phenylacetylene [$\delta = 3.05$ (s) ppm]. Ethyl nitroacetate (**1b**) and norbornene (**2a**) (Figure 2-1, B): by integrating the *CHON* proton signal [$\delta = 4.64$ (d) ppm] of the cycloadduct **6** and the ethylene protons of norbornene [$\delta = 5.98$ (s) ppm]. *N*-Methyl-2-nitroacetamide (**1g**) and 5-nitro-1-pentene (**2f**) (Figure 2-1, C): by integrating the 5-H proton signal [$\delta =$

4.70– 4.80 (m) ppm] of the cycloadduct **30** and an ethylene proton of 5-nitro-1-pentene [δ = 5.64–5.88 (m) ppm]. Ethyl nitroacetate (**1b**) and 3-buten-1-ol (**2e**) (Figure 2-1, D): by integrating the 5-H proton signal [δ = 4.78–5.08 (m) ppm] of the cycloadduct **26** and an ethylene proton of 3-buten-1-ol [δ = 5.68–5.88 (m) ppm]. The residual nitro compound was evaluated by integrating its methylene protons (δ = 5.88, 5.19, 5.08 ppm for **1a**, **1b** and **1g**, respectively). Without base no conversion was observed. In the case of an unclear result a duplicate experiment was run.

Preparation of *N*-Benzyl-2-nitroacetamide (**1h**):

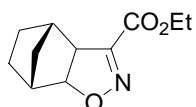


A mixture of ethyl nitroacetate (**1b**) (1.33 g, 10 mmol) and benzylamine (10.9 mL, 10 equiv.) was heated whilst stirring at 60 °C. After 16 h, the mixture was cooled and 3 n HCl was added to pH = 3. The mixture was then extracted with diethyl ether (2×30 mL). The combined organic layers were washed with 5% HCl (2×15 mL), dried with Na₂SO₄, filtered and concentrated in vacuo. Trituration of the resultant solid with cold Et₂O yielded the amide **1h** as a white solid. Yield: 0.970 g, 50%. M.p. 97–98 °C (ref. ²⁸ 87–89 °C). ¹H NMR: δ = 4.48 (d, *J* = 5.6 Hz, 2 H, CH₂Ph), 5.08 (s, 2 H, CH₂NO₂), 6.77 (br. s, 1 H, NH), 7.26–7.38 (m, 5 H, Ph-H) ppm. ¹³C NMR: δ = 44.1 (t, CH₂Ph), 77.7 (t, CH₂NO₂), 127.8 (d, 2 C, Ph-C), 128.1 (d, Ph-C), 128.9 (d, 2 C, Ph-C), 136.6 (s, Ph-C), 159.8 (s, C=O) ppm. IR (CDCl₃): ν = 3419 (NH), 1692 (C=O), 1564, 1527 cm⁻¹. MS (EI): *m/z* (%) = 194 (1) [M]⁺, 148 (100) [M - NO₂]⁺, 133 (6) [PhCH₂NCO]⁺, 107 (81), 91 (89) [PhCH₂]⁺. C₉H₁₀N₂O₃ (194.19): calcd. C 55.67, H 5.19, N 14.43; found C 55.85, H 5.10, N 14.28.

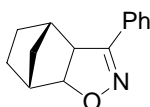
²⁸ S. G. Manjunatha, K. V. Reddy, S. Rajappa *Tetrahedron Lett.* **1990**, 31, 1327 – 1330.

General Procedure for the Preparation of Isoxazolines 5, 22, 24, 26–30 and Isoxazoles 21, 31, 33–35 (Table 2-1):

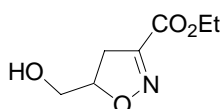
A solution of nitro compound (**1a–b** and **1f–h**) (1.06 mmol unless otherwise stated, 2.5 equiv.), base (0.05–0.175 equiv.) and dipolarophile (0.424 mmol, 1 equiv.) in chloroform or ethanol (1.4 mL) was stirred for the indicated time in a sealed vessel (Schlenk) at 60 or 80 °C. The solvent was then removed and the residue purified by chromatography directly or after the reported workup.

Isoxazoline 5 [Ethyl 3-Oxa-4-azatricyclo[5.2.1.0^{2,6}]dec-4-ene-5-carboxylate]:³

Isoxazoline **5** was prepared according to the general procedure from **1b** and norbornene (**2a**) in chloroform at 60 °C (40 h) using DABCO (**3**) (0.1 equiv.) as the base. The residue was dissolved in diethyl ether (15 mL), washed with brine (3×15 mL portions), satd. Na₂CO₃ solution (3×15 mL portions), and brine again (3×15 mL portions). The organic layer was dried (sodium sulfate), filtered and concentrated. Clear oil. Yield 89 mg, 100%. ¹H NMR (400 MHz, CDCl₃): δ = 1.08–1.43 (m, 4 H, Norb-H), 1.34 (t, 3 H, J = 7.1 Hz, CH₃), 1.49–1.57 (m, 2 H, Norb-H), 2.56 (m, 1 H, Norb-H), 2.59 (m, 1 H, Norb-H), 3.27 (d, J = 8.4 Hz, 1 H, CHC=N), 4.31 (m, 2 H, OCH₂), 4.64 (d, J = 8.4 Hz, 1 H, CHON) ppm. ¹³C NMR (100.58 MHz, CDCl₃): δ = 14.1 (q, CH₃), 22.6 (t, Norb-C), 27.2 (t, Norb-C), 32.3 (t, Norb-C), 39.3 (d, Norb-C), 42.9 (d, Norb-C), 56.5 (d, CC=N), 61.9 (t, OCH₂), 90.3 (d, CON), 152.3 (s, C=N), 160.9 (s, C=O) ppm. MS (EI): *m/z* (%) = 209 (49) [M]⁺, 192 (19), 164 (20), 67 (100). IR (KBr): ν = 2968, 1718 (C=O), 1583 cm⁻¹. C₁₁H₁₅NO₃ (209.2); calcd. C 63.14, H 7.23, N 6.69; found C 63.36, H 7.52, N 6.40.

Isoxazoline 22 [5-Phenyl-3-oxa-4-azatricyclo[5.2.1.0^{2,6}]dec-4-ene]:³

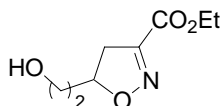
Isoxazoline **22** was prepared according to the general procedure from **1f** and norbornene (**2a**) in chloroform at 60 °C (72 h) using DABCO (**3**) (0.1 equiv.) as the base. The residue was dissolved in diethyl ether (15 mL), washed with water (3×15 mL portions), 1 M NaOH (3×15 mL portions) and brine (3×15 mL portions) in sequence. The organic layer was dried (sodium sulfate), filtered and concentrated. The crude product was triturated in ice-cold diethyl ether and then filtered. Yellowish solid. Yield: 89 mg, 98%. M.p. 95–97 °C (ref. 98–99 °C). ¹H NMR (400 MHz, CDCl₃): δ = 1.16–1.39 (m, 4 H, Norb-*H*), 1.50–1.62 (m, 2 H, Norb-*H*), 2.51 (m, 1 H, Norb-*H*), 2.60 (s, 1 H, Norb-*H*), 3.48 (d, *J* = 8.4 Hz, 1 H, *CHC=N*), 4.62 (d, *J* = 8.4 Hz, 1 H, *CHOH*), 7.30–7.43 (m, 3 H), 7.64–7.77 (m, 2 H, Ph-*Hortho*) ppm. ¹³C NMR (100.58 MHz, CDCl₃): δ = 22.7 (t, Norb-*C*), 27.4 (t, Norb-*C*), 32.3 (t, Norb-*C*), 39.2 (d, Norb-*C*), 42.9 (d, Norb-*C*), 57.0 (d, *CC=N*), 87.8 (d, *CON*), 126.8 (d, 2 C, Ph-*Cortho*), 128.6 (d, 2 C Ph-*Cmeta*), 129.3 (s, Ph-*Cipso*), 129.7 (d, Ph-*Cpara*), 156.9 (s, *C=N*) ppm. MS (EI): *m/z* (%) = 213 (100) [*M*]⁺, 184 (12), 157 (40), 146 (38), 117 (38), 104 (20), 77 (46) [*Ph*]⁺. IR (KBr): ν = 2969, 1594, 1446, 1354 cm⁻¹. C₁₄H₁₅NO (213.28): calcd. C 78.84, H 7.09, N 6.57; found C 78.87, H 7.09, N 6.42.

Isoxazoline 24 [Ethyl 5-(Hydroxymethyl)-4,5-dihydro-3-isoxazolecarboxylate]:

Isoxazoline **24** was prepared according to the general procedure from **1b** and allyl alcohol (**2d**) in ethanol at 80 °C (36 h) using DABCO (**3**) (0.10 equiv.) as the base. The residue was dissolved in dichloromethane (10 mL), silica gel (200 mg) was added to the mixture and the solvent evaporated. The silica gel with the adsorbed product was loaded onto the top of a column of silica gel and purified

by chromatography. Eluent: hexane/diethyl ether, 6:1, then diethyl ether, $R_f = 0.31$. Clear liquid. Yield: 70 mg, 95%. $^1\text{H NMR}$: $\delta = 1.34$ (t, $J = 7.2\text{Hz}$, 3 H, $\text{CH}_3\text{CH}_2\text{O}$), 1.96 (br. s, 1 H, OH), 3.05–3.28 (m, 2 H, 4-H), 3.62 (dd, $J = 4.4$ and 12.4 Hz , 1 H, CHOH), 3.84 (dd, $J = 3.2$ and 12.4 Hz , 1 H, CHOH), 4.33 (q, $J = 7.2\text{ Hz}$, 2 H, $\text{CH}_3\text{CH}_2\text{O}$), 4.84–4.93 (m, 1 H, 5-H) ppm. $^{13}\text{C NMR}$: $\delta = 14.1$ (q, $\text{CH}_3\text{CH}_2\text{O}$), 34.8 (t, C-4), 62.1 (t, $\text{CH}_3\text{CH}_2\text{O}$), 63.3 (t, CH_2OH), 83.8 (d, C-5), 152.1 (s, C-3), 160.4 (s, C=O) ppm. IR (CDCl_3): $\nu = 3600$ (OH), 2985, 1720 (C=O), 1593 (C=N), 1258 cm^{-1} . MS (EI): m/z (%) = 173 (4) $[\text{M}]^+$, 142 (39), 128 (27), 70 (100). $\text{C}_7\text{H}_{11}\text{NO}_4$ (173.17): calcd. C 48.55, H 6.40, N 8.09; found C 48.26, H 6.39, N 7.88.

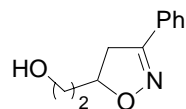
Isoxazoline 26 [Ethyl 5-(2-Hydroxyethyl)-4,5-dihydro-3-isoxazolecarboxylate]:



Isoxazoline **26** was prepared according to the general procedure from **1b** (4.24 mmol) and 3-buten-1-ol (**2e**) in chloroform at $60\text{ }^\circ\text{C}$ (40 h) using DABCO (**3**) (0.175 equiv.) as the base. The residue was purified by chromatography to afford 310 mg (97%) of **26**. In other experiments carried out according to the general procedure the reaction carried out in chloroform at $60\text{ }^\circ\text{C}$ using 4-DMAP (**32**) (0.1 equiv.) as the base or in ethanol at $80\text{ }^\circ\text{C}$ using DABCO (**3**) (0.175 equiv.) as the base afforded the isoxazoline **26** in 96 and 97% yields, respectively. Eluent: dichloromethane then dichloromethane/ methanol, 20:1, $R_f = 0.27$. Clear oil. $^1\text{H NMR}$: $\delta = 1.32$ (t, $J = 7.1\text{Hz}$, 3 H, $\text{CH}_3\text{CH}_2\text{O}$), 1.81–1.87 (m, 1 H, $\text{CH}_2\text{C-5}$), 1.91–1.99 (m, 1 H, $\text{CH}_2\text{C-5}$), 2.04 (br. s, 1 H, OH), 2.89 (dd, $J = 8.0$ and 18.0 Hz , 1 H, 4-H), 3.28 (dd, $J = 11.2$ and 18.0 Hz , 1 H, 4-H), 3.72–3.82 (m, 2 H, CH_2OH), 4.29 (q, $J = 7.1\text{ Hz}$, 2 H, $\text{CH}_3\text{CH}_2\text{O}$), 4.90–5.00 (m, 1 H, 5-H) ppm. $^{13}\text{C NMR}$: $\delta = 14.2$ (q, $\text{CH}_3\text{CH}_2\text{O}$), 37.7 (t, $\text{CH}_2\text{C-5}$), 38.9 (t, C-4), 59.1 (t, CH_2OH), 62.1 (t, $\text{CH}_3\text{CH}_2\text{O}$), 81.7 (d, C-5), 151.5 (s, C-3), 160.5 (s, C=O) ppm. IR (CDCl_3): $\nu = 3625$ (OH), 1720 (C=O), 1589 (C=N), 1381, 1257 cm^{-1} . MS (EI): m/z (%) = 187 (1)

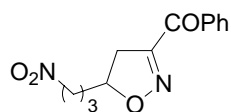
$[M]^+$, 142 (100) $[M - OEt]^+$, 114 (66) $[M - CO_2Et]^+$, 96 (28). $C_8H_{13}NO_4$ (187.19): calcd. C 51.33, H 7.00, N 7.48; found C 51.65, H 6.97, N 7.70.

Isoxazoline 27 [(3-Phenyl-4,5-dihydroisoxazol-5-yl)ethanol]:



Isoxazoline **27** was prepared according to the general procedure from **1f** and 3-buten-1-ol (**2e**) in ethanol at 80 °C (40 h) using DABCO (**3**) (0.10 equiv.) as the base. The residue was purified by chromatography to afford 76 mg (94%) of **27**. In another experiment carried out according to the general procedure, the reaction in chloroform at 60 °C (40 h) using DABCO (**3**) (0.10 equiv.) as the base afforded the isoxazoline **27** in 49% yield. Eluent: hexane then hexane/ethyl acetate, 2:3, $R_f = 0.28$. White solid. M.p. 78–79 °C (ref. ²⁹ 78 °C). 1H NMR: $\delta = 1.86$ – 1.95 (m, 1 H, CH_2C-5), 1.96 – 2.05 (m, 1 H, CH_2C-5), 3.06 (dd, $J = 8.0$ and 16.4 Hz, 1 H, 4-H), 3.46 (dd, $J = 10.4$ and 16.4 Hz, 1 H, 4-H), 3.82 – 3.92 (m, 2 H, CH_2OH), 4.88 – 4.96 (m, 1 H, 5-H), 7.36 – 7.42 (m, 3 H, Ph-H), 7.62 – 7.68 (m, 2 H, Ph-H) ppm. ^{13}C NMR: $\delta = 37.8$ (t, CH_2C-5), 40.5 (t, C-4), 59.9 (t, CH_2OH), 79.5 (d, C-5), 126.6 (d, 2 C, Ph-C), 128.7 (d, 2 C, Ph-C), 129.5 (s, Ph-C), 130.1 (d, Ph-C), 156.8 (s, C-3) ppm. IR ($CDCl_3$): $\nu = 3623$ (OH), 1601 , 1356 cm^{-1} . MS (EI): m/z (%) = 191 (13) $[M]^+$, 146 (100) $[M - CH_2CH_2OH]^+$, 118 (29), 77 (75) $[Ph]^+$. $C_{11}H_{13}NO_2$ (191.23): calcd. C 69.09, H 6.85, N 7.32; found C 68.80, H 6.55, N 7.15.

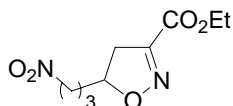
Isoxazoline 28 [[5-(3-Nitropropyl)-4,5-dihydro-3-isoxazolyl] (phenyl)-methanone]:



²⁹ M. J. Fray, E. J. Thomas, *Tetrahedron* **1984**, *40*, 673 – 680.

Isoxazoline **28** was prepared according to the general procedure from **1a** and 5-nitro-1-pentene (**2f**) in chloroform at 60 °C (72 h) using NMI (**13**) (0.05 equiv.) as the base. The residue was dissolved in diethyl ether (15 mL), washed with brine (3×15 mL portions), 3 M NaOH (3×15 mL portions) and brine again (3×15 mL portions). The organic layer was dried (sodium sulfate), filtered and concentrated. The residue was dissolved in dichloromethane (10 mL), silica gel (200 mg) was added to the mixture and the solvent evaporated. The silica gel with the adsorbed product was loaded onto the top of a column of silica gel and purified by chromatography. Eluent: hexane/diethyl ether, 6:1, then hexane/diethyl ether, 3:2, $R_f = 0.15$. Clear oil. Yield: 93 mg, 83%. $^1\text{H NMR}$: $\delta = 1.73\text{--}1.88$ (m, 2 H, $\text{CH}_2\text{C-5}$), 2.10–2.30 (m, 2 H, $\text{CH}_2\text{CH}_2\text{C-5}$), 3.02 (dd, $J = 8.0$ and 17.8 Hz, 1 H, 4-H), 3.43 (dd, $J = 10.8$ and 17.8 Hz, 1 H, 4-H), 4.39–4.52 (m, 2 H, CH_2NO_2), 4.77–4.86 (m, 1 H, 5-H), 7.42–7.50 (m, 2 H, Ph-*Hmeta*), 7.56–7.62 (m, 1 H, Ph-*Hpara*), 8.14–8.21 (m, 2 H, Ph-*Hortho*) ppm. $^{13}\text{C NMR}$: $\delta = 23.4$ (t, $\text{CH}_2\text{CH}_2\text{C-5}$), 32.0 (t, $\text{CH}_2\text{C-5}$), 39.2 (t, C-4), 74.9 (t, CH_2NO_2), 81.9 (d, C-5), 128.2 (d, 2 C, Ph-*Cmeta*), 130.1 (d, 2 C, Ph-*Cortho*), 133.5 (d, Ph-*Cpara*), 135.4 (s, Ph-*Cipso*) 157.5 (s, C-3), 185.9 (s, C=O) ppm. IR (CDCl_3): $\nu = 2936, 1652$ (C=O), 1598 (C=N) 1555 (ON–O), 1365 (ON–O) cm^{-1} . MS (EI): m/z (%) = 262 (7) $[\text{M}]^+$, 174 (42), 105 (100) $[\text{PhCO}]^+$, 77 (83) $[\text{Ph}]^+$. $\text{C}_{13}\text{H}_{14}\text{N}_2\text{O}_4$ (262.26): calcd. C 59.54, H 5.38, N 10.68; found C 59.34, H 4.92, N 10.33.

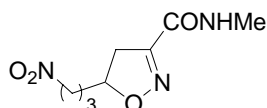
Isoxazoline 29 [Ethyl 5-(3-Nitropropyl)-4,5-dihydro-3-isoxazolecarboxylate]:



Isoxazoline **29** was prepared according to the general procedure from **1b** and 5-nitro-1-pentene (**2f**) in chloroform at 60 °C (72 h) using DABCO (**3**) (0.10 equiv.) as the base. The residue was purified by chromatography. Eluent: hexane/diethyl ether, 1:1, $R_f = 0.30$. Clear liquid. Yield: 96 mg, 98%. $^1\text{H NMR}$: $\delta = 1.32$ (t, $J = 7.0$ Hz, 3 H, CH_3CH_2), 1.68–1.82 (m, 2 H, $\text{CH}_2\text{C-5}$), 2.04–2.22 (m, 2

H, $\text{CH}_2\text{CH}_2\text{C}-5$), 2.83 (dd, $J = 8.0$ and 17.8 Hz, 1 H, 4-H), 3.29 (dd, $J = 10.9$ and 17.8 Hz, 1 H, 4-H), 4.30 (q, $J = 7.0$ Hz, 2 H, CH_3CH_2), 4.36–4.48 (m, 2 H, CH_2NO_2), 4.76–4.84 (m, 1 H, 5-H) ppm. ^{13}C NMR: $\delta = 14.0$ (q, CH_3CH_2), 23.1 (t, $\text{CH}_2\text{CH}_2\text{C}-5$), 31.8 (t, $\text{CH}_2\text{C}-5$), 38.6 (t, C-4), 62.1 (t, CH_3CH_2), 74.8 (t, CH_2NO_2), 82.5 (d, C-5), 151.4 (s, C-3), 160.4 (s, C=O) ppm. IR (CDCl_3): $\nu = 1720$ (C=O), 1590 (C=N) 1555 (ON-O), 1379, (ON-O) cm^{-1} . MS (EI): m/z (%) = 231 (6) $[\text{MH}]^+$, 213 (4), 185 (33) $[\text{MH} - \text{NO}_2]^+$, 155 (64), 142 (100) 114 (92) $[\text{MH} - \text{NO}_2(\text{CH}_2)_3\text{CHO}]^+$. $\text{C}_9\text{H}_{14}\text{N}_2\text{O}_5$ (230.22): calcd. C 46.95, H 6.13, N 12.17; found C 47.29, H 6.16, N 12.19.

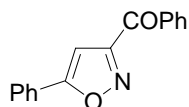
Isoxazoline 30 [N-Methyl-5-(3-nitropropyl)-4,5-dihydro-3-isoxazolecarboxamide]:



Isoxazoline **30** was prepared according to the general procedure from **1g** and 5-nitro-1-pentene (**2f**) in chloroform at $60\text{ }^\circ\text{C}$ (120 h) using DABCO (**3**) (0.05 equiv.) as the base. The residue was dissolved in ethyl acetate (15 mL) and washed with brine (3×15 mL portions), 1 M NaOH (3×15 mL portions), and brine again (3×15 mL portions). The organic layer was dried (sodium sulfate), filtered and concentrated to afford **30** (70 mg). More **30** was obtained by back-extraction of the combined aqueous layers with ethyl acetate (3×30 mL) and concentration of the extracts (10 mg). White solid. Yield: 80 mg, 88%. M.p. 75–76 $^\circ\text{C}$. ^1H NMR: $\delta = 1.62$ – 1.78 (m, 2 H, $\text{CH}_2\text{C}-5$), 2.02–2.20 (m, 2 H, $\text{CH}_2\text{CH}_2\text{C}-5$), 2.87 (d, $J = 5.2$ Hz, 3 H, CH_3), 2.88 (dd, $J = 8.0$ and 17.9 Hz, 1 H, 4-H), 3.30 (dd, $J = 10.9$ and 17.9 Hz, 1 H, 4-H), 4.36–4.48 (m, 2 H, CH_2NO_2), 4.70–4.80 (m, 1 H, 5-H), 6.64 (br. s, 1 H, NH) ppm. ^{13}C NMR: $\delta = 23.3$ (t, $\text{CH}_2\text{CH}_2\text{C}-5$), 26.1 (q, CH_3N), 31.8 (t, $\text{CH}_2\text{C}-5$), 38.6 (t, C-4), 74.9 (t, CH_2NO_2), 82.3 (d, C-5), 153.9 (s, C-3), 160.1 (s, C=O) ppm. IR (CDCl_3): $\nu = 3434$ (N-H), 2941, 1678 (C=O), 1595, 1555 cm^{-1} . MS (EI): m/z (%) = 215 (1) $[\text{M}]^+$, 185 (1) $[\text{M} - \text{NHCH}_3]^+$, 58 (100) $[\text{CONHMe}]^+$.

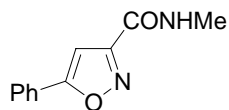
C₈H₁₃N₃O₄ (215.21): calcd. C 44.65, H 6.09, N 19.53; found C 44.35, H 6.10, N 19.68.

Isoxazole 31 [(Phenyl)(5-phenyl-3-isoxazolyl)methanone]:¹⁷



Isoxazole **31** was prepared according to the general procedure from **1a** and phenylacetylene (**2c**) in chloroform at 60 °C (20 h) using 1-methylimidazole (**13**) (0.05 equiv.) as the base. The solvent was then removed and the residue dissolved in diethyl ether (15 mL), washed with brine (3×15 mL portions), 1 M NaOH (3×15 mL portions) and brine again (3×15 mL portions). The organic layer was dried (sodium sulfate), filtered and concentrated. When necessary the workup was repeated. White solid. Yield: 103 mg, 97%. M.p. 77–78 °C (ref. 78–79 °C). ¹H NMR (400 MHz, CDCl₃): δ = 3.38 (dd, *J* = 8.8 and 17.8 Hz, 1 H, 4-H), 3.77 (dd, *J* = 11.4 and 17.8 Hz, 1 H, 4-H), 5.76 (dd, *J* = 8.8 and 11.4 Hz, 1 H, 5-H), 7.29–7.41 (m, 5 H, Ar-H), 7.48 (m, 2 H, Ar-H), 7.61 (m, 1 H, Ar-H), 8.24 (m, 2 H, COPh-*Hortho*) ppm. ¹³C NMR (100.58 MHz, CDCl₃): δ = 41.8 (t, C-4), 84.2 (d, C-5), 125.9 (d, 2 C, Ar-C), 128.4 (d, 2 C, Ar-C), 128.6 (d), 128.8 (d, 2 C, Ar-C), 130.3 (d, 2 C, Ar-C), 133.6 (d), 135.7 (s, Ar-C), 139.7 (s, Ar-C), 157.4 (s, C=N), 186.2 (s, COPh) ppm. MS (EI): *m/z* (%) = 251 (25) [M]⁺, 234 (12), 205 (4), 204 (4), 105 (100) [PhCO]⁺, 77 (55). IR: ν = 3068, 3030, 2926, 2857, 1672, 1652, 1599, 1581, 1572 cm⁻¹. C₁₆H₁₃NO₂ (251.28): calcd. C 76.48, H 5.21, N 5.57; found C 77.31, H 4.69, N 6.01.

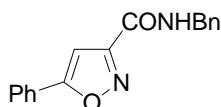
Isoxazole 21 [N-Methyl-5-phenyl-3-isoxazolecarboxamide]:³



Isoxazole **21** was prepared according to the general procedure from **1g** and phenylacetylene (**2c**) in chloroform at 60 °C (72 h) using DABCO (**3**) (0.05 equiv.) as the base. The residue was dissolved in diethyl ether (15 mL) and washed with brine (3×15 mL portions), 1 M NaOH (3×15 mL portions) and

brine again (3×15 mL portions) in sequence. The organic layer was dried (sodium sulfate), filtered and concentrated. White solid. Yield: 73 mg, 84%. M.p. 192–193 °C (ref. 198–199 °C). ¹H NMR (400 MHz, CDCl₃): δ = 3.01 (d, *J* = 4.8 Hz, 3 H, NCH₃), 6.95 (s, 1 H, 4-H), 7.42–7.50 (m, 3 H, Ph-H), 7.74–7.80 (m, 2 H, Ph-H) ppm. ¹³C NMR (100.58 MHz, CDCl₃): δ = 26.1 (q, NCH₃), 99.0 (d, C-4), 125.9 (d, 2 C, Ph-Cortho), 126.8 (s, Ph-Cipso), 129.1 (d, 2 C, Ph-Cmeta), 130.7 (d, Ph-Cpara), 159.1 (s, C-3)*, 159.6 (s, C=O)*, 171.7 (s, C-5), ppm; *may be exchanged. MS (EI): *m/z* (%) = 202 (38) [M]⁺, 172 (34) [M - NHCH]⁺, 145 (20), 105 (56) [PhCO]⁺, 77 (44) [Ph]⁺, 58 (100) [CONHMe]⁺. IR (CHCl₃): ν = 3433, 1685 (C=O), 1551, 1447 cm⁻¹. C₁₁H₁₀N₂O₂ (202.21): calcd. C 65.34, H 4.98, N 13.85; found C 64.95, H 5.21, N 13.95.

Isoxazole 33 [*N*-Benzyl-5-phenyl-3-isoxazolecarboxamide]:

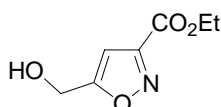


Isoxazole **33** was prepared according to the general procedure from **1h** and phenylacetylene (**2c**) in chloroform at 60 °C (72 h) using DABCO (**3**) (0.05 equiv.) as the base. The residue was dissolved in diethyl ether (15 mL) and washed with water (3×15 mL portions), 1 M NaOH (3×15 mL portions) and brine (3×15 mL portions) in sequence. The organic layer was dried (sodium sulfate), concentrated and the residue dissolved in dichloromethane (6 mL). Silica gel (200 mg) was added to the mixture and the solvent evaporated. The silica gel with the adsorbed product was loaded onto the top of a column of silica gel and purified by chromatography. Eluent: hexane/diethyl ether, 3:1, *R_f* = 0.25. White solid. Yield: 77 mg, 68%. M.p. 151–152 °C (ref. ³⁰ 152 °C). ¹H NMR: δ = 4.64 (d, *J* = 5.8 Hz, 2 H, CH₂Ph), 6.98 (s, 1 H, 4-H), 7.10–7.19 (br. s, 1 H, NH), 7.27–7.32 (m, 1 H, Bn-H), 7.33–7.36 (m, 4 H, Bn-H), 7.44–7.50 (m, 3 H, Ph-Hmeta and Ph-Hpara), 7.78–7.80 (m, 2 H, Ph-Hortho) ppm. ¹³C NMR: δ = 43.5 (t,

³⁰ T. Benincori, E. Brenna, F. Sannicola *J. Chem. Soc. Perkin Trans. 1* **1993**, 675 – 680.

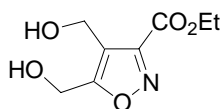
NCH₂Ph), 99.2 (d, C-4), 125.9 (d, 2 C, Ph-*Cortho*), 126.8 (s, Ph-*Cipso*), 127.8 (d, Bn-C), 127.9 (d, 2 C, Bn-C), 128.8 (d, 2 C, Bn-C), 129.1 (d, 2 C, Ph-*Cmeta*), 130.7 (d, Ph-*Cpara*), 137.3 (s, Bn *Cipso*), 158.8 (s, C-3)*, 159.0 (s, C=O)*, 171.7 (s, C-5) ppm; * may be exchanged. IR: ν = 3416 (NH), 1683 (C=O), 1541, 1447 cm⁻¹. MS (EI): m/z (%) = 278 (37) [M]⁺, 277 (90) [M - 1]⁺, 201 (10), 173 (22), 146 (54), 105 (83) [PhCO]⁺, 91 (100) [PhCH₂]⁺, 77 (60) [Ph]⁺. C₁₇H₁₄N₂O₂ (278.31): calcd. C 73.37, H 5.07, N 10.07; found C 73.40, H 5.36, N 10.02.

Isoxazole **34** [Ethyl 5-(Hydroxymethyl)-3-isoxazolecarboxylate]:



Isoxazole **34** was prepared according to the general procedure from **1b** and propargyl alcohol (**2g**) in ethanol at 80 °C (72 h) using DABCO (**3**) (0.10 equiv.) as the base. The solvent was then removed and the residue purified by chromatography to afford 72 mg (98%) of **18**. In another experiment carried out according to the general procedure, the reaction in chloroform at 60 °C (72 h) using DABCO (**3**) (0.10 equiv.) as the base afforded the isoxazole **34** in 74% yield. Eluent: dichloromethane and then dichloromethane/ methanol, 40:1, R_f = 0.29. Clear liquid. ¹H NMR: δ = 1.40 (t, J = 6.8 Hz, 3 H, CH₃), 2.19 (br. s, 1 H, OH), 4.42 (q, J = 6.8 Hz, 2 H, OCH₂), 4.81 (s, 2 H, CH₂OH), 6.66 (t, $4J$ = 0.8 Hz, 1 H, 4-H) ppm. ¹³C NMR: δ = 14.1 (q, CH₃), 56.4 (t, CH₂OH), 62.3 (t, OCH₂), 102.6 (d, C-4), 156.4 (s, C-3), 159.8 (s, C=O), 173.1 (s, C-5) ppm. IR: ν = 3609 (OH), 1734 (C=O), 1600, 1470 cm⁻¹. MS (EI): ³¹ m/z (%) = 171 (4) [M]⁺, 126 (30) [M - OEt]⁺, 68 (100). C₇H₉NO₄ (171.15): calcd. C 49.12, H 5.30, N 8.18; found C 49.22, H 5.44, N 7.96.

³¹ A signal at higher m/z (296) observed in the MS spectrum indicates that transesterification occurred on heating (250 °C inject temperature).

Isoxazole 35 [Ethyl 4,5-Bis(hydroxymethyl)-3-isoxazolecarboxylate]:

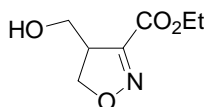
Isoxazole **35** was prepared according to the general procedure from **1b** and 2-butyne-1,4-diol (**2h**) in ethanol at 80 °C (72 h) using DABCO (**3**) (0.1 equiv.) as the base. The residue was purified by chromatography to afford **19** (25 mg, 29%). The reaction repeated with a larger excess of ethyl nitroacetate (282 mg, 2.124 mmol, 5 equiv.) for 90 h afforded 39 mg (46%) of **35**. In another experiment, according to the general procedure, the reaction carried out in ethanol at 80 °C (72 h) using 4-DMAP (**32**) (0.10 equiv.) as the base afforded the isoxazole **35** in 21% yield. Eluent: dichloromethane then dichloromethane/methanol, 50:1, then dichloromethane/ methanol, 20:1, R_f = 0.22. Clear oil. $^1\text{H NMR}$: δ = 1.42 (t, J = 7.2 Hz, 3 H, CH_2CH_3), 3.20–3.48 (br. s, 2 H, $2\times\text{CH}_2\text{OH}$), 4.45 (q, J = 7.2 Hz, 2 H, CH_2CH_3), 4.75 (s, 2 H, CH_2OH), 4.80 (s, 2 H, CH_2OH) ppm. $^{13}\text{C NMR}$: δ = 14.1 (q, CH_3CH_2), 53.8 (t, CH_2OH), 55.3 (t, CH_2OH), 62.7 (t, CH_3CH_2), 117.3 (s, C-4), 154.3 (s, C-3), 161.09 (s, C=O), 169.9 (s, C-5) ppm. IR: ν = 3608 (OH), 1719 (C=O), 1555 cm^{-1} . MS (EI): m/z (%) = 200 (2) $[\text{M} - \text{H}]^+$, 184 (10) $[\text{M} - \text{OH}]^+$, 170 (13), 142 (100), 128 (28), 114 (52), 110 (95). $\text{C}_8\text{H}_{11}\text{NO}_5$ (201.18): calcd. C 47.76, H 5.51, N 6.96; found C 47.47, H 5.28, N 7.21.

Scale-Up of the Preparation of Isoxazoline 24 [Ethyl 5-(Hydroxymethyl)-4,5-dihydro-3-isoxazolecarboxylate]:

In a sealed 50 mL Schlenk flask DABCO (**3**) (67 mg, 0.601 mmol, 0.1 equiv.) was dissolved in anhydrous ethanol (20 mL). Ethyl nitroacetate (**1b**) (2.00 g, 15.0 mmol, 2.5 equiv.) was added to this solution followed by allyl alcohol (**2d**) (0.349 g, 6.01 mmol). The flask was placed in an oil bath heated at 80 °C and the mixture stirred (gentle reflux) for 24 h. The solvent was then removed under reduced pressure and the residue purified by chromatography eluting with diethyl ether/ petroleum ether, 10:1, to yield 874 mg (R_f = 0.94, 1.1 equiv.

corresponding to 73% of the expected recovery) of recovered nitroacetate (**1b**) and 968 mg (93% yield, $R_f = 0.32$) of isoxazoline **24** as a clear oil containing less than 5% of the corresponding 4-substituted regioisomer **25** as a clear liquid. A further chromatographic separation, under the same conditions, allowed the two regioisomers to be separated.

Isoxazole 25 [ethyl 4-(hydroxymethyl)-4,5-dihydro-3-isoxazolecarboxylate]:



$^1\text{H NMR}$: $\delta = 1.37$ (t, $J = 7.2$ Hz, 3 H, $\text{CH}_3\text{CH}_2\text{O}$), 2.53 (br. s, 1 H, OH), 3.64–3.74 (m, 1 H, 4-H), 3.80–3.86 (m, 2 H, CH_2OH), 4.28–4.44 (m, 3 H, $\text{CH}_3\text{CH}_2\text{O}$, 5-H), 4.64 (dd, $J = 8.8$ and 11.2 Hz, 1 H, 5-H) ppm. $^{13}\text{C NMR}$: $\delta = 14.0$ (q, $\text{CH}_3\text{CH}_2\text{O}$), 49.7 (d, C-4), 62.0 (t, CH_2OH), 62.5 (t, $\text{CH}_3\text{CH}_2\text{O}$), 74.6 (t, C-5), 152.1 (s, C-3), 161.6 (s, C=O) ppm. IR (CDCl_3): $\nu = 1716$ (C=O) cm^{-1} . MS (EI): m/z (%) 173 (4) $[\text{M}]^+$, 142 (65), 128 (23), 115 (87), 97 (100). $\text{C}_7\text{H}_{11}\text{NO}_4$ (173.17): calcd. C 48.55, H 6.40, N 8.09; found C 48.22, H 6.06, N 7.76. The spectral data of **24** are identical to those reported above.

Chapter 3

3. Michael Addition versus Cycloaddition-Condensation of Ethyl Nitroacetate with Electron-deficient Olefins

3.1. Introduction

The anion derived from base treatment of a nitro compound is known to undergo conjugate addition with electron-poor olefins.³² These (Michael type³³) reactions [Scheme 3-1, Eq. (1)] have been widely explored and exploited for many poly-functional targets.^{34,35,36,37,38,39,40}

³² N. Ono, *The Nitro Group in Organic Synthesis*, Wiley-VCH, Weinheim, **2001**, p. 103.

³³ a) A. Michael, *J. Prakt. Chem.* **1886**, 35, 349–356; b) A. Michael, *J. Prakt. Chem.* **1894**, 49, 20–25.

³⁴ For reviews on the conjugate additions of nitroalkanes, see: a) R. Ballini, G. Bosica, D. Fiorini, A. Palmieri, M. Petrini, *Chem. Rev.* **2005**, 105, 933–972; b) R. Ballini, L. Barboni, G. Bosica, D. Fiorini, A. Palmieri, *Pure Appl. Chem.* **2006**, 78, 1857–1866.

Strong bases such as tetramethylguanidine (TMG),^{41,42} DBU,^{43,44,45,46,47,48} benzyltrimethylammonium hydroxide (Triton B^{49,50,51}) or NaOH⁵² are

³⁵ For a review on the asymmetric conjugate additions of nitroalkanes, see: D. Almas, i. D. A. Alonso, C. Nájera, *Tetrahedron: Asymmetry* **2007**, *18*, 299–365.

³⁶ For selected examples of asymmetric conjugate addition of nitroalkanes, see: a) X. Yang, X. Zhou, L. Lin, L. Chang, X. Liu, X. Feng, *Angew. Chem.* **2008**, *120*, 7187–7189; *Angew. Chem. Int. Ed.* **2008**, *47*, 7079–7081; b) C. Rabalakos, W. D. Wulff, *J. Am. Chem. Soc.* **2008**, *130*, 13524–13525; c) Y. Wang, P. Li, X. Liang, T. Y. Zhang, J. Ye, *Chem. Commun.* **2008**, 1232–1234; d) E. Reyes, H. Jiang, A. Milelli, P. Elsner, R. G. Hazell, K. A. Jørgensen, *Angew. Chem.* **2007**, *119*, 9362; *Angew. Chem. Int. Ed.* **2007**, *46*, 9202; e) L. Zu, H. Xie, H. Li, J. Wang, W. Wang, *Adv. Synth. Catal.* **2007**, *349*, 2660–2664; f) T. Ooi, S. Takada, K. Doda, K. Maruoka, *Angew. Chem.* **2006**, *118*, 7768–7770; *Angew. Chem. Int. Ed.* **2006**, *45*, 7606–7608; g) L. Hojabri, A. Hartikka, F. M. Moghaddam, P. I. Arvidsson, *Adv. Synth. Catal.* **2007**, *349*, 740–748; h) S.-F. Lu, D.-M. Du, J. Xu, S.-W. Zhang, *J. Am. Chem. Soc.* **2006**, *128*, 7418–7419; i) C. E. T. Mitchell, S. E. Brenner, S. V. Ley, *Chem. Commun.* **2005**, 5346–5348; j) M. S. Taylor, D. N. Zalatan, A. M. Lerchner, E. N. Jacobsen, *J. Am. Chem. Soc.* **2005**, *127*, 1313–1317.

³⁷ For domino processes including conjugated addition of nitroalkanes, see a) G. L. Zhao, I. Ibrahim, P. Dziedzic, J. Sun, C. Bonneau, A. Córdova, *Chem. Eur. J.* **2008**, *14*, 10007–10011; b) A. Carlone, S. Cabrera, M. Marigo, K. A. Jørgensen, *Angew. Chem.* **2007**, *119*, 1119–1122; *Angew. Chem. Int. Ed.* **2007**, *46*, 1101–1104.

³⁸ For dendrimers, see: a) P. Goyal, K. Yoon, M. Weck, *Chem. Eur. J.* **2007**, *13*, 8801–8810; b) G. R. Newkome, K. S. Yoo, H. J. Kim, C. N. Moorefield, *Chem. Eur. J.* **2003**, *9*, 3367–3374; c) G. R. Newkome, R. Güther, C. N. Moorefield, F. Cardullo, L. Echegoyen, E. Perez-Cordero, H. Luftmann, *Angew. Chem.* **1995**, *107*, 2159–2162; *Angew. Chem. Int. Ed. Engl.* **1995**, *34*, 2023–2026.

³⁹ For modified amino acids, see: a) M. J. Crossley, Y. M. Fung, J. J. Potter, A. W. Stamford, *J. Chem. Soc. Perkin Trans. 1* **1998**, 1113–1122; b) P. A. Coghlan, C. J. Easton, *J. Chem. Soc. Perkin Trans. 1* **1999**, 2659–2660; c) R. Ballini, C. Balsamini, F. Bartocchini, M. Gianotti, C. Martinelli, N. Savoretti, *Synthesis* **2005**, 296–300; d) Y. Fu, L. G. J. Hammarström, T. J. Miller, F. R. Fronczek, M. L. McLaughlin, R. P. Hammer, *J. Org. Chem.* **2001**, *66*, 7118–7124.

⁴⁰ For other selected examples, see: a) R. Zschiesche, H. U. Reissig, *Liebigs Ann. Chem.* **1988**, 1165–1168; b) Y. Nakashita, M. Hesse, *Angew. Chem. Int. Ed. Engl.* **1991**, *30*, 1021; c) K. Kawai, T. Ebata, T. Kitazume, *J. Fluorine Chem.* **2005**, *126*, 956–961; d) J. R. Duvall, F. Wu, B. B. Snider, *J. Org. Chem.* **2006**, *71*, 8579–8590; e) J. L. García Ruano, T. de Haro, R. Singh, M. B. Cid, *J. Org. Chem.* **2008**, *73*, 1150–1153.

⁴¹ G. P. Pollini, A. Barco, G. De Giuli, *Synthesis* **1972**, 44–45.

⁴² K. Nakamura, T. Kitayama, Y. Inoue, A. Ohno, *Bull. Chem. Soc. Jpn.* **1990**, *63*, 91–96.

⁴³ N. Ono, H. Miyake, A. Kamimura, N. Tsukui, A. Kaji, *Tetrahedron Lett.* **1982**, *23*, 2957–2960.

⁴⁴ A. Powell, M. Al Nakeeb, B. Wilkinson, J. Micklefield, *Chem. Commun.* **2007**, 2683–2685.

⁴⁵ S. C. Kim, H. S. Lee, Y. J. Lee, J. N. Kim, *Tetrahedron Lett.* **2006**, *47*, 5681–5685.

⁴⁶ C. Milne, A. Powell, J. J. M. Al Nakeeb, C. P. Smith, J. Micklefield, *J. Am. Chem. Soc.* **2006**, *128*, 11250–11259.

⁴⁷ G. B. Rosso, R. A. Pilli, *Tetrahedron Lett.* **2006**, *47*, 185–188.

⁴⁸ X. Bi, D. Dong, Q. Liu, W. Pan, L. Zhao, B. Li, *J. Am. Chem. Soc.* **2005**, *127*, 4578–4579.

⁴⁹ K. Yoon, P. Goyal, *Org. Lett.* **2007**, *9*, 2051–2054.

usually required to generate the nucleophilic species. However, “activated” nitro compounds [Scheme 3-1, Eq. (1), R¹ = EWG] are strong enough to undergo the reaction with catalysis by bases of moderate strength⁵³ (triethylamine,^{54,55,56,57,58} PPh₃^{59,60}) or even without a base if the electron-poor olefin is very reactive, such as methyl vinyl ketone.^{61,62}

A primary nitro compound is shown in this chapter to give, in competition with conjugate addition, a cycloaddition-condensation process involving the nitro group and leading to isoxazole derivatives [Scheme 3-1, Eq. (2)].⁶³ In fact, it was recently reported that cycloaddition-condensation of activated primary nitro compounds with

⁵⁰ R. Zschiesche, H. U. Reissig, *Liebigs Ann. Chem.* **1988**, 1165 – 1168.

⁵¹ K. H. Lui, M. P. Sammes, *J. Chem. Soc. Perkin Trans. 1* **1990**, 457-468.

⁵² R. Ballini, G. Bosica, *Eur. J. Org. Chem.* **1998**, 355 –357.

⁵³ Y. N. Belokon, K. A. Kochetkov, T. D. Churkina, N. S. Ikonnikov, S. A. Orlova, N. A. Kuz'mina, D. E. Bodrov, *Russ. Chem. Bull.* **1993**, 102, 1525 – 1529; [Y. N. Belokon, K. A. Kochetkov, T. D. Churkina, N. S. Ikonnikov, S. A. Orlova, N. A. Kuz'mina, D. E. Bodrov, *Izv. Akad. Nauk SSSR Ser. Khim.* **1993**, 9, 1591 – 1595].

⁵⁴ V. M. Danilenko, A. A. Tishkov, S. L. Ioffe, I. M. Lyapkalo, Y. A. Strelenko, V. A. Tartakovskiy, *Synthesis* **2002**, 635 –647.

⁵⁵ K. P. Birin, A. A. Tishkov, S. L. Ioffe, Y. A. Strelenko, V. A. Tartakovskiy, *Russ. Chem. Bull.* **2003**, 52, 647 – 658; [K. P. Birin, A. A. Tishkov, S. L. Ioffe, Y. A. Strelenko, V. A. Tartakovskiy, *Izv. Akad. Nauk SSSR Ser. Khim.* **2003**, 3, 620 –631].

⁵⁶ J. Killoran, J. F. Gallagher, P. V. Murphy, D. F. O Shea, *New J. Chem.* **2005**, 29, 1258 – 1265.

⁵⁷ D. Bardelang, A. Rockenbauer, H. Karoui, J. P. Finet, I. Biskupska, K. Banaszak, P. Tordo, *Org. Biomol. Chem.* **2006**, 4, 2874 –2882.

⁵⁸ G. Buchi, J. H. Botkin, G. C. M. Lee, K. Yakushijin, *J. Am. Chem. Soc.* **1985**, 107, 5555 – 5556.

⁵⁹ Y. N. Ogibin, A. I. Ilovaiskii, V. M. Merkulova, G. I. Nikishin, *Russ. Chem. Bull.* **2003**, 52, 728 – 733; [Y. N. Ogibin, A. I. Ilovaiskii, V. M. Merkulova, G. I. Nikishin, *Izv. Akad. Nauk SSSR Ser. Khim.* **2003**, 3, 697 – 702].

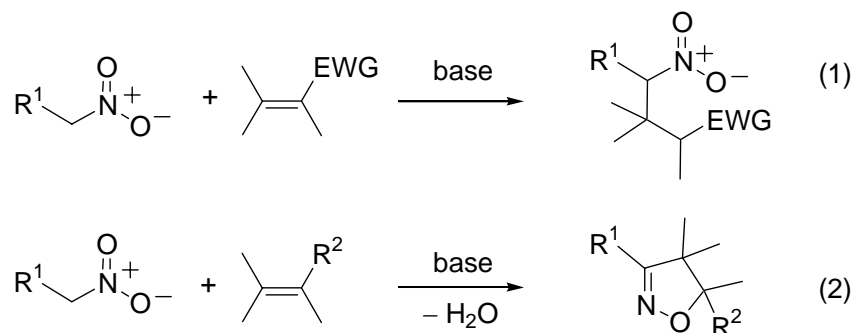
⁶⁰ N. Ono, H. Miyake, A. Kaji, *J. Chem. Soc. Chem. Commun.* **1983**, 875 – 876.

⁶¹ S. Shirakawa, S. Shimizu, *Synlett* **2007**, 3160 –3164.

⁶² A. Lubineau, *J. Aug, Tetrahedron Lett.* **1992**, 33, 8073 –8074.

⁶³ a) D. Giomi, F. M. Cordero, F. Machetti in *Comprehensive Heterocycle Chemistry III* (Eds.: A. Katritzky, C. Ramsden, E. Scriven, R. Taylor), Elsevier, Amsterdam. **2008**; b) V. Jäger, P. A. Colinas in *Synthetic Applications of 1,3-Dipolar Cycloaddition Chemistry Toward Heterocycles and Natural Products* (Eds.: A. Padwa, W. H. Pearson), Wiley, New York, **2003**; c) J. Mulzer, *Organic Synthesis Highlights*, VCH, Weinheim, **1991**; d) K. B. G. Torsell, *Nitrile Oxides Nitrones and Nitronates in Organic Synthesis*; VCH, Weinheim, **1988**, Chapter 5; e) P. Caramella, P. Grünanger in *1,3-Dipolar Cycloaddition Chemistry* (Ed.: A. Padwa), Wiley, New York, **1984**.

alkenes or alkynes takes place under base catalysis, the best results being obtained with those having two basic centres and that are most suited for H-bonding (e.g. 1,4-Diazabicyclo[2.2.2]octane, DABCO, **3**) [Scheme 3-1, Eq. (2), R¹ = EWG].^{3,4,11}



Scheme 3-1.

Therefore, electron-deficient olefins [Scheme 3-1, Eq. (2), R² = EWG] are expected to react with the anion of an activated primary nitro compound according to either [Eq. (1)] and [Eq. (2)] shown in the Scheme 3-1. The conditions affecting the competition between these two processes are considered and discussed in this chapter, in order to establish how catalyst and reaction conditions could favour one result or the other.

3.2. Results and discussion

Ethyl nitroacetate (**1b**), assumed as a model “activated” nitro compound,^{64,65} under base catalysis (DABCO, **3**), reacts with compounds

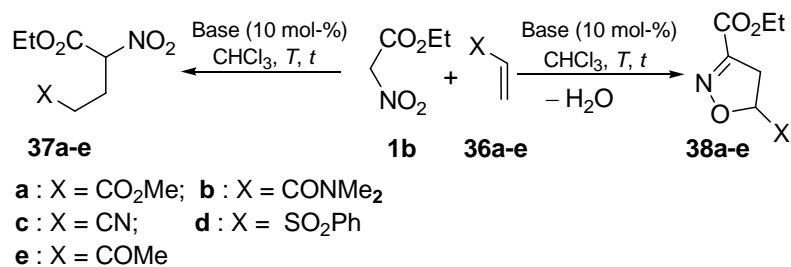
⁶⁴ M. T. Shipchandler, *Synthesis* 1979, 666 – 686.

⁶⁵ For selected recent studies and applications of nitroacetates, see: a) P. G. Cozzi, L. Zoli, *Angew. Chem.* **2008**, *120*, 4230 – 4234; *Angew. Chem. Int. Ed.* **2008**, *47*, 4162 –4166; b) R. R. Shakirov, T. V. Dokichev, R. Z. Biglova, N. M. Vlasova, N. Z. Baibulatova, R. F. Talipov *Chem. Heterocycl. Compd.* **2008**, *44*, 43– 49; c) N. A. Gavrilova, E. S. Semichenko, O. S. Korotchenko, G. A. Suboch, *Russ. J. Org. Chem.* **2008**, *44*, 624 –625; [N. A. Gavrilova, E. S.

containing an electron-deficient double bond (**36a-e**) in two ways to give either the Michael-type open-chain adducts (**37a-e**) or the cycloadducts (**38a-e**) as a result of water elimination.

The results reported in Table 3-1, strongly depend on the dipolarophile and on the reaction conditions. The condensation appears to be favoured with respect to the conjugate addition as the temperature increases (*cf.* entries 1 and 2, 5 and 6, 9 and 10, 13 and 14).

Semichenko, O. S. Korotchenko, G. A. Suboch, *Zh. Org. Khim.* **2008**, *44*, 628–629]; d) D. B. Ramachary, M. Kishor, Y. V. Reddy, *Eur. J. Org. Chem.* **2008**, 975–993; e) R. R. Shakirov, T. V. Dokichev, R. Z. Biglova, N. M. Vlasova, N. Z. Baibulatova, R. F. Talipov, *Chem. heterocycl. Compd.* **2008**, *44*, 43–49; [R. R. Shakirov, T. V. Dokichev, R. Z. Biglova, N. M. Vlasova, N. Z. Baibulatova, R. F. Talipov, *Khim. Geterotsikl. Soedin.* **2008**, 53–60]; f) C. F. Bernasconi, M. Prez-Lorenzo, S. D. Brown, *J. Org. Chem.* **2007**, *72*, 4416–4423; g) S. Nakamura, H. Sugimoto, T. Ohwada, *J. Am. Chem. Soc.* **2007**, *129*, 1724–1732; h) H. Sugimoto, S. Nakamura, T. Ohwada, *Adv. Synth. Catal.* **2007**, *349*, 669–679; i) V. Singh, S. Batra, *Eur. J. Org. Chem.* **2007**, 2970–2976; j) A. Singh, R. A. Yoder, B. Shen, J. N. Johnston, *J. Am. Chem. Soc.* **2007**, *129*, 3466–3467; k) N. Coia, D. Bouyssi, G. Balme, *Eur. J. Org. Chem.* **2007**, 3158–3165; l) A. Szumna, *Org. Biomol. Chem.* **2007**, *5*, 1358–1368; m) N. Z. Tugusheva, L. M. Alekseeva, A. S. Shashkov, V. G. Granika, *Russ. Chem. Bull.* **2006**, *55*, 1470–1474; [N. Z. Tugusheva, L. M. Alekseeva, A. S. Shashkov, V. G. Granika, *Izv. Akad. Nauk. Ser. Khim.* **2006**, *8*, 1416–1420]; n) J.-P. Strachan, R. C. Whitaker, C. H. Miller, B. S. Bhatti, *J. Org. Chem.* **2006**, *71*, 9909–9911; o) L. Minuti, A. Marrocchi, I. Teseia, E. Gacs-Baitz, *Tetrahedron Lett.* **2005**, *46*, 8789–8792; p) B. Moreau, A. B. Char Charette, *J. Am. Chem. Soc.* **2005**, *127*, 18014–18015; q) N. N. Kondrashova, M.-G. A. Shvekhgeimer, *Dokl. Chem.* **2004**, *398*, 187–190; [N. N. Kondrashova, M.-G. A. Shvekhgeimer, *Dokl. Akad. Nauk.* **2004**, *398*, 349–352]; r) P. Ploypradith, C. Mahidol, P. Sahakitpichan, S. Wongbundit, S. Ruchirawat, *Angew. Chem.* **2004**, *116*, 884–886; *Angew. Chem. Int. Ed.* **2004**, *43*, 866–866; s) T. Sommermann, B. G. Kim, K. Peters, E.-M. Peters, T. Linker, *Chem. Commun.* **2004**, 2624–2625; t) K. P. Birin, A. A. Tishkov, S. L. Ioffe Yu. A. Strelenko, V. A. Tartakovsky, *Russ. Chem. Bull.* **2003**, *52*, 647–658; [K. P. Birin, A. A. Tishkov, S. L. Ioffe Yu. A. Strelenko, V. A. Tartakovsky, *Izv. Akad. Nauk. Ser. Khim.* **2003**, *3*, 620–631]; u) H. M. Liu, F. Zhang, D. P. Zou, *Chem. Commun.* **2003**, 2044–2045; v) L. A. Rodinovskaya, K. S. Chunikhin, A. M. Shestopalov, *Chem. Heterocycl. Compd.* **2002**, *38*, 442–448; [L. A. Rodinovskaya, K. S. Chunikhin, A. M. Shestopalov, *Khim. Geterotsikl. Soedin.* **2002**, *4*, 507–514]; w) A. B. Charette, P. Ryan T. Ollevier, *Helv. Chim. Acta* **2002**, *85*, 4468–4484; x) J. T. Lowe, A. Chandrasekaran, R. O. Day, W. Rosen, *Chem. Commun.* **2001**, 1390–1391; y) B. M. Trost, J.P. Surivet, *Angew. Chem.* **2000**, *112*, 3252–3254; *Angew. Chem. Int. Ed.* **2000**, *39*, 3122–3124.

Table 3-1. Effect of temperature and base on the ratio between Michael adduct **36a-e** and cycloadduct **37a-e**.^[a]

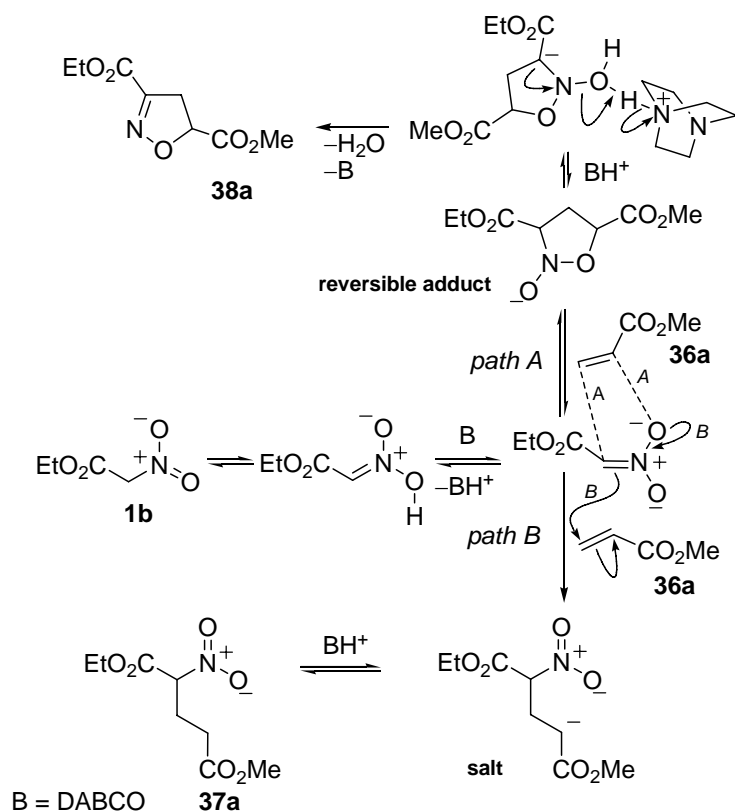
Entry	36	Base ^[b]	T (° C)	t (h)	Conv. [%] ^[c]	Yield [%] ^[d] 36a-e	Yield [%] ^[d] 37a-e
1	a ^[e]	DABCO	30	240	88	88	0
2	a	DABCO	60	48	100	59	41
3	a	NMP	60	168	100	47	52
4	b	DBU	60	88	79	79	0
5	b ^[e]	DABCO	30	240	10	24	0
6	b	DABCO	60	48	100	18	82
7	b	NMP	60	120	69	13	55
8	b	DIPEA	60	168	39	38	0
9	c	DABCO	30	240	100	64	36
10	c	DABCO	60	168	86	41	36
11	c	NMP	60	120	67	30	37
12	c ^[e]	DBU	60	18	100	91	0
13	d ^[e]	DABCO	30	96	100	90	0
14	d	DABCO	60	20	100	80	19
15	d	NMP	60	96	87	58	29

Entry	36	Base ^[b]	T (° C)	t (h)	Conv. [%] ^[c]	Yield [%] ^[d] 36a-e	Yield [%] ^[d] 37a-e
16	e ^[e]	NMP	60	18	100	82	0
17	e	NMI	60	18	100	88	11
18	e	DABCO	60	18	100	97	0

[a] See experimental section for details. [b] DABCO: 1,4-diazabicyclo[2.2.2]octane; NMP: N-methylpiperidine; DBU: 1,8-Diazabicyclo[5.4.1]undec-7-ene; DIPEA: diisopropylethylamine; NMI: N-methylimidazole. [c] Conversion based on the consumption of dipolarophile and determined by ¹H NMR spectroscopy. [d] Spectroscopic yield determined by ¹H NMR with the use of an internal standard. [e] Compound 30-34 was isolated and characterised, see experimental section.

Attempted use of other bases indicates that a very strong base such as DBU (**3b**) greatly favours the Michael-type open-chain adducts compared to cycloadducts (*cf.* entries 4 and 6), while DABCO (**3**) ensures a faster conversion, with variable proportions of products: moreover the molar ratio between (*e. g.*) **37a** and **38a** changes as the reaction proceeds. However it was verified that compounds **37a-e** and **38a-e** do not convert each other in the reaction conditions, therefore the ratio between them does not depend on kinetic *vs.* thermodynamic control. The model reaction between ethyl nitroacetate (**1b**) and methyl acrylate (**36a**) has been monitored by ¹H NMR. Molar concentrations of the dipolarophile **36a** and of the products **37a** and **38a** are plotted *vs.* time at different base concentrations (Figure 3-1). The formation of the cycloadduct **38a** exhibits a long induction period, thus suggesting a mechanism where a reversible cycloaddition of the nitronate to the dipolarophile precedes the rate determining step, in which irreversible water release leads to the product **38a** (Scheme 3-2, *path A*).⁵ Indeed, it would be hard to explain why cycloadduct (**38a-e**) is favoured with respect to open-chain

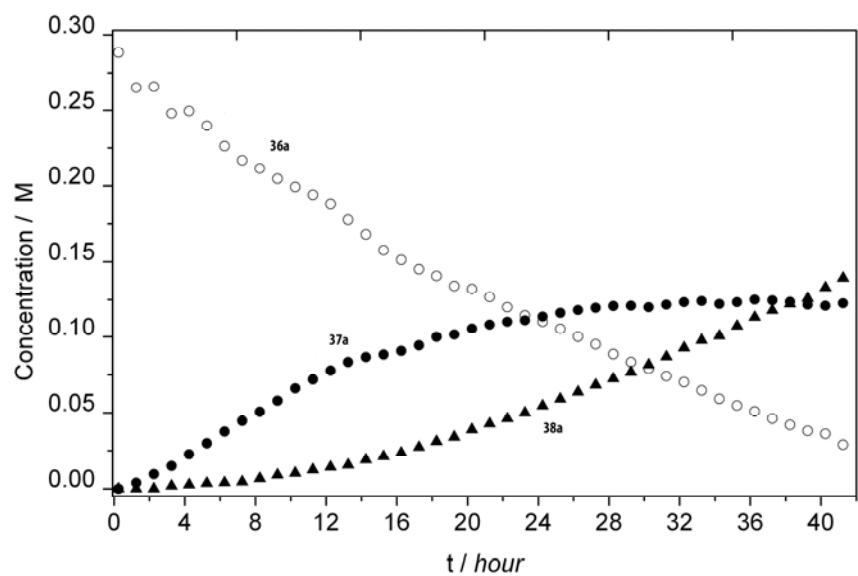
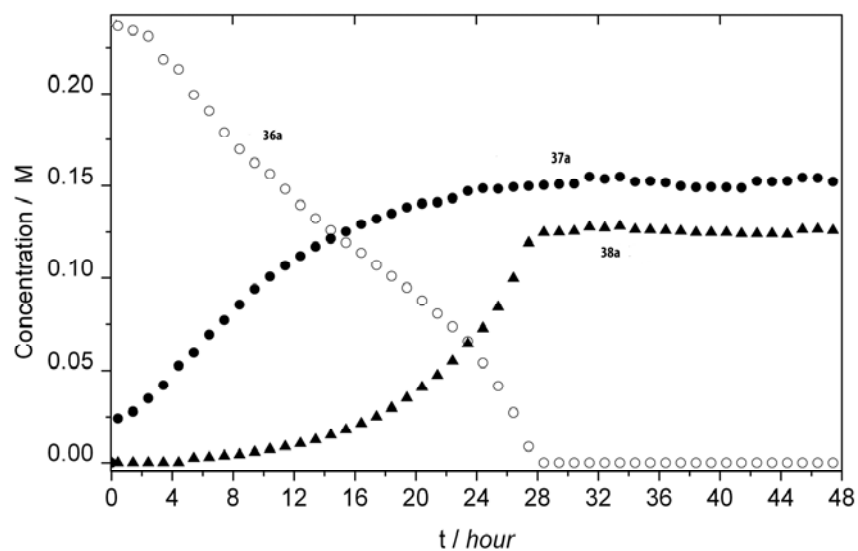
Michael adduct (**37a-e**) as the temperature increases (Table 3-1), if cycloaddition were the rate determining step. The conjugate addition (Scheme 3-2, *path B*) takes place without significant induction time, and its initial rate can be approximately evaluated from the graphs (Figure 3-1) since during early reaction stages the condensation rate can be neglected. The reaction is first order in the base, as expected.⁶⁶



Scheme 3-2. Competition between conjugate addition (*path B*, curly arrows) and cycloaddition-condensation (*path A*, dotted interaction) in the model reaction of ethyl nitroacetate (**1b**) with methyl acrylate (**36a**).

⁶⁶ At concentration about 0.3M (**36a**) and 0.75M (**1b**) the following approximate rates were observed: $2.86 \times 10^{-6} \text{ mol (dm}^3\text{)}^{-1}\text{s}^{-1}$ (base 0.3M), $1.94 \times 10^{-6} \text{ mol (dm}^3\text{)}^{-1} \text{ s}^{-1}$ (base 0.0225M), $0.646 \times 10^{-6} \text{ mol (dm}^3\text{)}^{-1} \text{ s}^{-1}$ (base 0.015M).

Therefore the cycloaddition-condensation to **38a** becomes predominant at low base concentration (Figure 3-1, bottom), since the induction time is apparently barely affected. However, the conversion requires exceedingly long times to be completed.



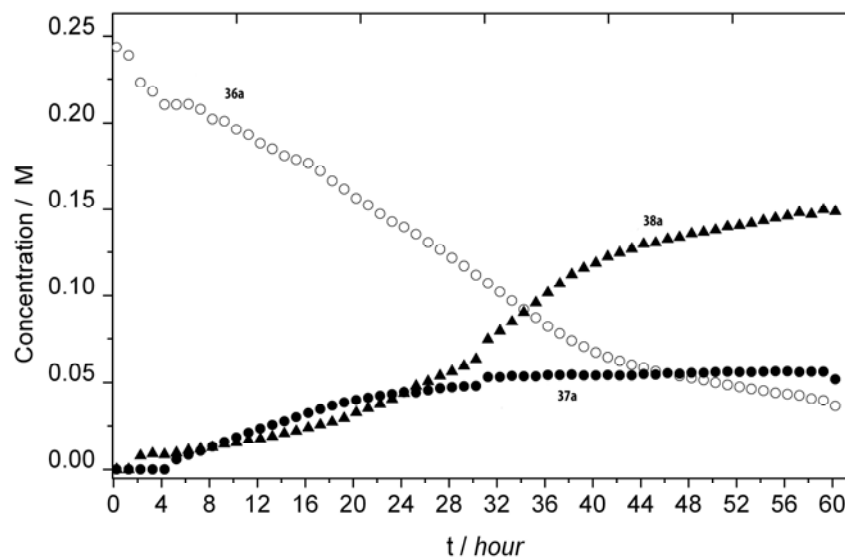


Figure 3-1. Kinetic profiles for reactions between ethyl nitroacetate (**1b**) and methyl acrylate (**36a**) in the presence of DABCO at **36a**/DABCO molar ratios of 1:0.1 (top), 1:0.075 (middle) and 1:0.05 (bottom). Plots of **36a** (\circ), **37a** (\bullet) and **38a** (\blacktriangle) concentrations versus time. The reactions were each performed in a septum-sealed NMR tube in the probe of the spectrometer at 60 °C. See Experimental Section for details.

3.2.1. The use of Copper salt

As reported recently, in the presence of a base, addition of catalytic Cu^{II} salt allows various dipolarophiles to undergo the cycloaddition-condensation not only with activated nitro compounds, but with nitroalkanes, too.^{5,67} Surprisingly, in these conditions, nitroalkanes give excellent yields of the corresponding isoxazolines also with methyl acrylate, among other substrates.

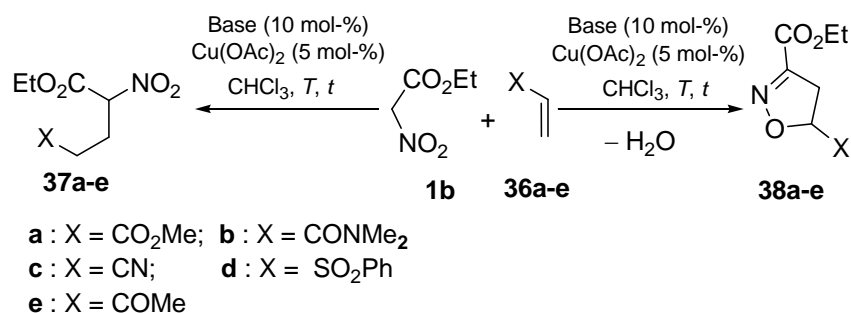
Therefore the reactions considered so far (Table 3-1) have been repeated in the presence of Cu^{II} salt. Addition of a copper salt to the catalytic system dramatically increases the proportion of cycloadduct **38a-e**,

⁶⁷ L. Cecchi, F. De Sarlo, F. Machetti *Synlett* **2007**, 2451 – 2453.

which is often the sole reaction product (Table 3-2). Significant amounts of open chain adducts **37a-e** are obtained from phenyl vinyl sulfone (**36d**) and methyl vinyl ketone (**36e**), while in other reactions minor amounts of open adducts can be observed only at 30 °C (Table 3-2, entries 1, 8).

Thus the effect of the temperature in product ratio follows the same trend observed in the reactions without copper (II) (Table 3-1). In reactions of methyl vinyl ketone (**36e**) the ratio between the products **37e** and **38e** depends on the base employed (Table 3-2, entries 14–19), however we were unable to achieve a high selectivity towards **38e**.

Table 3-2. Effect of copper(II) acetate on the ratio between Michael adduct (**37a-e**) and cycloadduct (**38a-e**).^[a]



Entry	36	Base ^[b]	T (°C)	t (h)	Conv. [%] ^[c]	Yield [%] ^[d] 37a-e	Yield [%] ^[d] 38a-e
1	a	DABCO	30	240	100	24	74
2	a	DABCO	60	20	100	0	98
3	a	NMP	60	20	100	0	94
4	b	DABCO	30	240	100	0	98
5	b	DABCO	60	20	100	0	100

Entry	36	Base ^[b]	T (°C)	t (h)	Conv. [%] ^[c]	Yield [%] ^[d] 37a-e	Yield [%] ^[d] 38a-e
6	b	NMP	60	20	100	0	100
7	b	DIPEA	60	66	100	0	100
8	c	DABCO	30	168	57	17	38
9	c	DABCO	60	20	100	0	94
10	c	NMP	60	20	100	0	97
11	d	DABCO	30	144	75	26	48
12	d	DABCO	60	20	100	16	82
13	d	NMP	60	20	94	25	55
14	e	DABCO	60	18	100	75	18
15	e	NMM	60	18	100	28	70
16	e	NMI	60	18	100	50	47
17	e	Imidazole	60	18	100	73	27
18	e	DMP	60	18	100	53	47
19	e	NPyM	60	18	100	79	14

[a] See experimental section for details. [b] NMM: N-methylmorpholine; DMP: 1,4 Dimethylpiperazine; NPyM: N-(4-pyridinyl)morpholine. [c] Conversion based on the consumption of dipolarophile and determined by ¹H NMR spectroscopy. [d] Spectroscopic yield determined by ¹H NMR with the use of an internal standard.

Kinetic profiles for the reaction **1b** + **36a** [**36a** 1 equiv, DABCO (**3**) 0.1 equiv, Cu(OAc)₂ 0.05 equiv, in chloroform at 60°C] are illustrated in Figure 3-2 (plots a - d). The excess of nitroacetate (**1b**, in the range 2.5 to 1 equiv) affects the reaction course as shown in Figure 3-2: after 24 h, conversion is over 90%, even without excess of nitroacetate, while above 1.5 equivalent conversion is quantitative after 12 h.

Thus the presence of Cu^{II} causes a dramatic drop of the induction time, whereas the maximum rate appears to be scarcely affected. In fact, the

maximum reaction rates evaluated from graphs in Figure 3-2 (9 to 14 $\times 10^{-6}$ mol dm $^{-3}$ s $^{-1}$) and graph in Figure 3-1 (top) (6×10^{-6} mol dm $^{-3}$ s $^{-1}$) are not very different, the gap possibly arising from the difference in dipolarophile concentrations. These observations suggest that the copper salt has a catalytic effect mainly on the cycloaddition pre-equilibrium, while a minor effect (if any) is observed on the rate determining dehydration step.

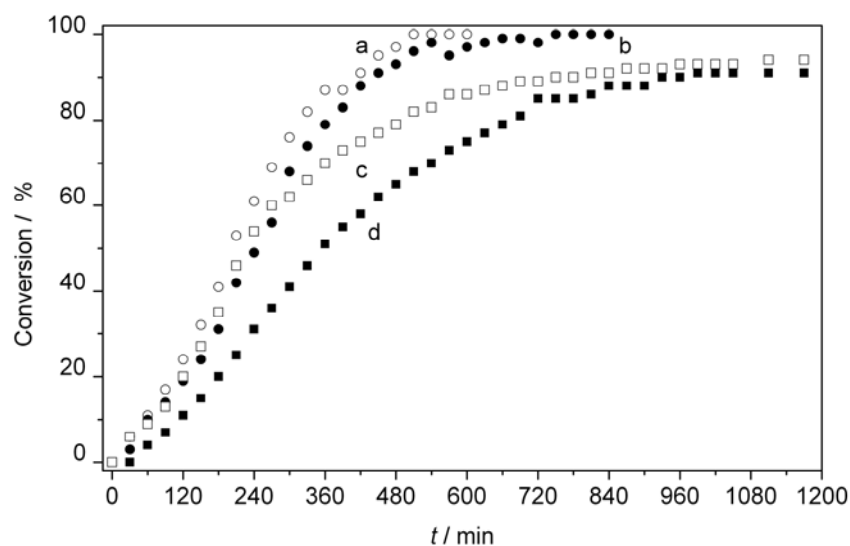


Figure 3-2. Kinetic profiles for condensations between ethyl nitroacetate (**1b**) and methyl acrylate (**36a**) at different 1/2a molar ratios: 2.5:1, plot **a** (\circ); 1.5:1, plot **b** (\bullet); 1.2:1, plot **c** (\square); 1:1, plot **d** (\blacksquare). The reactions were performed in septum-sealed NMR tubes in the probe of the spectrometer at 60 °C. See Experimental Section for details.

3.3. Synthetic opportunities

The scope of the reactions of ethyl nitroacetate (**1b**) has been extended to mono- and poly-substituted electron-poor dipolarophiles, employing the most favourable conditions leading to isoxazole derivatives. The reaction with methyl acrylate (**36a**), as it was shown before (Figure 3-2),

is conveniently carried out using 1.5 equivalents of ethyl nitroacetate (**1b**). These conditions represent the balance between conversion, reaction time and nitroacetate consuming. The same ratio has been applied to most reactions reported in Table 3-3 (entries 1 - 7), while a larger excess of **1b** (2.5 equiv) is required for the less reactive substrates (entries 8 - 10). N-Methylpiperidine (NMP, **3c**) has been employed as a base, but N-methylmorpholine (NMM, **3e**) has been preferred for methyl vinyl ketone (**36e**, see entry 15 in Table 3-2).

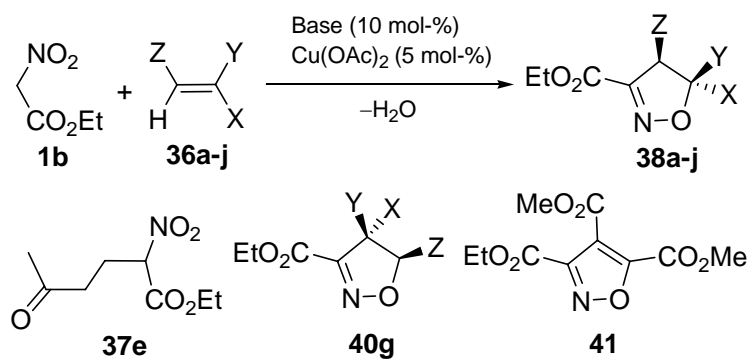
Under the copper/base catalytic system in chloroform at 60 °C, the cyclic dehydrated cycloadducts (**38a-j**) are the main products. Significant amount of the regioisomeric cycloadduct (**40g**) is only obtained from the reaction with methyl crotonate (**36g**).⁶⁸ Other by-products obtained in addition to cycloadducts are: the conjugate adduct **37e**, observed in the reaction with methyl vinyl ketone (**36e**), and the aromatised isoxazole **41**, from either reactions with dimethyl maleate (**36h**) and with dimethyl fumarate (**36i**). It is worth noting that the cycloaddition-condensation is faster with dimethyl maleate (**36h**) than with dimethyl fumarate (**36i**) and that these substrates give the same mixture of the diastereoisomers **39h** (*cis*, less than 10%) and **38h** (*trans*). These isoxazolines are both dehydrogenated to **41** in the reaction conditions:⁶⁹ in fact the observed amount of isoxazole **41** is higher in the reaction with dimethyl fumarate (**36i**) because it takes longer. The data in Table 3-3 refer to reactions aimed at the highest selectivity in favour of isoxazole derivatives **38a-j**. On the other hand, previous literature

⁶⁸ For examples of opposite regioselectivity of 1,3-DC of nitrile oxides with methyl crotonate see a) R. Huisgen, M. Christl, *Chem. Ber.* **1973**, *106*, 3291 - 3311; b) G. Faita, M. Mella, A. Mortoni, A. Paio, P. Quadrelli, P. Seneci *Eur. J. Org. Chem.* **2002**, 1175 - 1183; c) M. Gucma, W. M. Gołębiewski *J. Heterocyclic Chem.* **2008**, *45*, 241 - 245. d) M. Gołębiewski, M. Gucma, W. J. *Heterocyclic Chem.* **2008**, *45*, 1687 - 1693.

⁶⁹ F. De Sarlo, A. Guarna, A. Brandi *J. Heterocyclic Chem.* **1983**, *20*, 1505 - 1507.

data and the results reported here indicate that factors enhancing selectivity in favour of conjugate addition are: (i) absence of Cu^{II} catalyst, (ii) use of strong bases, *e.g.* DBU (**3b**), *cf.* entries 4 and 6 in Table 3-1, (iii) increase in base concentration, *cf.* Figure 3-1, (iv) increase in nitroacetate excess, as evidenced in the reaction with phenyl vinyl sulfone (**36d**). Thus, a large excess (2.5 equiv of nitroacetate **1b** with respect to olefin **36d**) give the ratio **37d** / **38d** = 25 / 55 (entry 13, Table 3-2), while 1.5 equiv of **1b** afford, in the same conditions, **38d** as the sole product in 83 % of yield (entry 4, Table 3-3) However, a detailed preparative study of the conjugate adducts **37a-e** was beyond the aims of this research.

Table 3-3. 4,5-Dihydroisoxazoles from ethyl nitroacetate (**1b**) and olefins **36a-j**.^[a]



Entry	36	X	Y	Z	Products ^[b]	Yield (%) ^[c]
1	a	CO ₂ Me	H	H	38a	89
2	b	CONMe ₂	H	H	38b	100
3	c	CN	H	H	38c	85
4	d	SO ₂ Ph	H	H	38d	83

Entry	36	X	Y	Z	Products ^[b]	Yield (%) ^[c]
5	e	COMe	H	H	(37e + 38e) ^[d]	90
6	f	CO ₂ Me	Me	H	38f	93
7	26	CO ₂ Me	H	Me	(38g + 40g) ^[e]	76
8	g	H	CO ₂ Me	CO ₂ Me	(38h + 38i) ^[f] + 41 ^[g]	86
9	h	CO ₂ Me	H	CO ₂ Me	(38h + 38i) ^[e] + 41 ^[h]	90
10	i	H	-CO-N(Ph)-CO-		38j	71

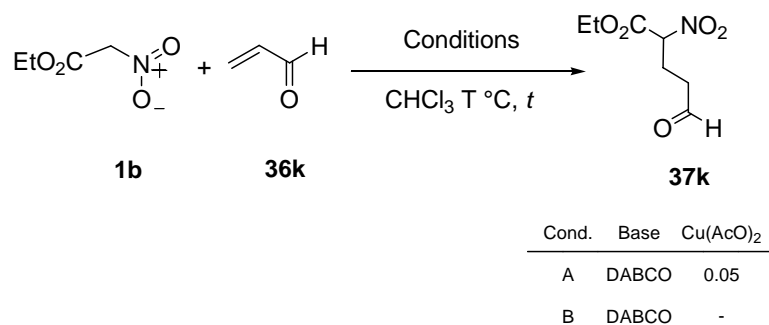
[a] See experimental section for more details. [b] Products in parenthesis could not be separated. [c] Isolated yield. [d] **38e** / **37e** = 2.5 : 1 molar ratio. [e] **38g** / **40g** = 1.8 : 1 molar ratio. [f] **38h** / **38i** = 1 : 10 molar ratio [g] (**38h** + **38i**) / **41** = 11 : 1 molar ratio. [h] (**38h** + **38i**) / **41** = 1 : 2 molar ratio.

3.4. Other Dipolarophiles less or differently reactive

Other dipolarophiles in addition to the olefins **36a-j** were used with ethyl nitroacetate (**1b**) in the conditions illustrated above, but these reagents have shown a different behaviour, therefore are not included in Table 3-3.

- **Acrylaldehyde (36k)**

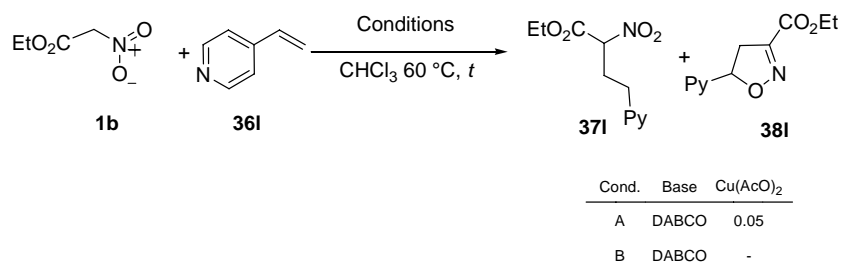
The reaction was carried out at 60 °C in presence or in absence of copper salt, but the cycloadduct was not observed. The product obtained was probably the Michael adduct (**37k**) (Scheme 3-3), but it is not easy to purificate, because of his low stability. For this reason, the reaction was carried out in shorter time and at lower temperature, to preserve the product, but the starting material **36k** resulted already finished after two hours at 10 °C. The velocity of this reaction, beside the GCMS and IR analyses, has confirmed the open adduct structure (**37k**); the product was not further investigated.



Scheme 3-3.

- **4-Vinylpyridine (36l)**

The reactions were carried out in presence or in absence of Cu(AcO)₂ at 60 °C. When copper was added, a strong colour variation was observed, because of the strong interaction between the metal and pyridine **36l**. After 19 h the colour turned from green to dark red and the starting material (**36l**) was all over. The crude was then purified on silica gel and a mixture of products **37l** and **38l** was obtained (Scheme 3-4) with low yield; the products were not further investigated.

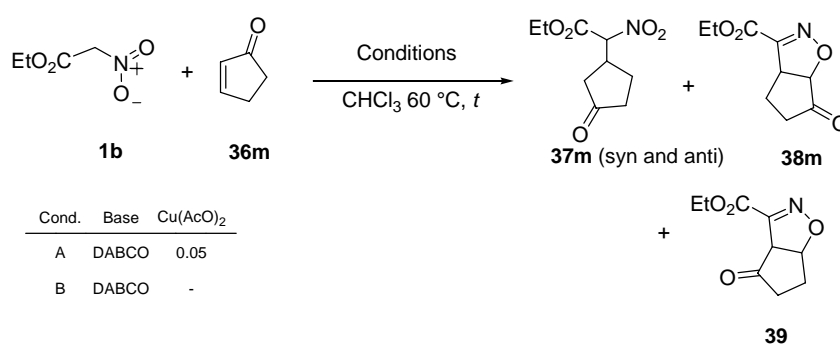


Scheme 3-4.

The mixture of the two products (**37l** and **38l**) was also obtained in absence of copper.

- **Cyclopent-2-en-1-one (36m)**

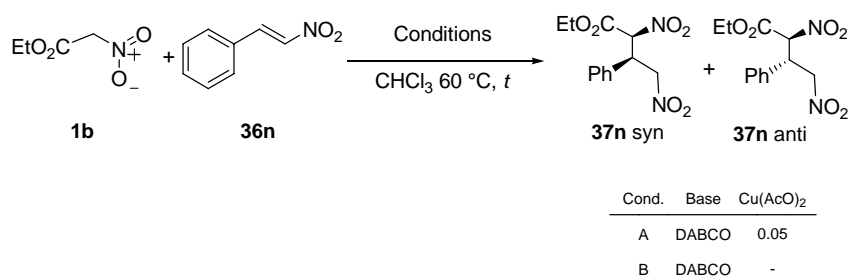
The reactions were carried out in presence or in absence of $\text{Cu}(\text{AcO})_2$ at $60\text{ }^\circ\text{C}$. With this dipolarophile **36m** the expected products are three (**37m**, **38m** and **39**) (Scheme 3-5); the open adduct (**37m**) was formed in the standard conditions in absence of metal, and a GC analysis has shown the presence of two diastereoisomers, syn and anti, in ratio 57: 43. In the presence of copper and with NMP (**3c**) as base, trace of cycloadducts (**38m** and **39**) were isolated. The products were not further investigated.



Scheme 3-5.

- **2-Nitrovinylbenzene (36n)**

The reactions were carried out in presence or in absence of $\text{Cu}(\text{AcO})_2$ at $60\text{ }^\circ\text{C}$, but in these conditions only the Michael adduct (**37n**) was formed (Scheme 3-6).



Scheme 3-6.

After purification on silica gel the product **37n** was obtained as a mixture of two diastereoisomers with 59 % yield.⁷⁰

- **1-Nitrocyclohexene (36o), 1-Acetyl-1-cyclohexene (36p) and 1,2-dimethoxy-4-(2-nitrovinyl)benzene (36q)**

The reactions were carried out in presence or in absence of $\text{Cu}(\text{AcO})_2$ at 60 °C, but with these dipolarophiles (**36o-q**) (Figure 3-3) any product was yielded.

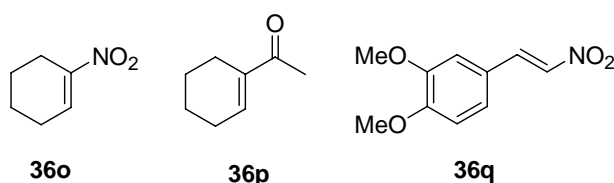


Figure 3-3. With these dipolarophiles any products were yielded.

3.5. Conclusions

The results illustrated in this chapter show, for the first time, that the reaction of a primary nitro compound with electron-deficient olefins can be modulated by using different conditions and catalytic systems (bases of various strength, presence of Cu^{II} salt) to cause either the well known conjugate addition (Michael reaction) or cycloaddition-condensation to isoxazole derivatives with involvement of the nitro group. Conjugate addition requires strong bases in most cases, whereas with weaker bases the cycloaddition-condensation can be faster but takes place after a long induction time; addition of Cu^{II} greatly reduces induction times, thus favouring the cycloaddition-condensation.

⁷⁰ M. D. Alcántara, F. C. Escribano, A. Gómez-Sánchez, M. J. Diáñez, M. D. Estrada, A. López-Castro, S. Pérez-Garrido *Synthesis*, **1996**, 64-70.

3.6. Experimental Section

General methods: for the instruments used and other details see Experimental Section in Chapter 2. All compounds were named with Autonom® (Beilstein Information Systems) and modified where appropriate.

Materials: Commercially available (Lancaster and Aldrich) ethyl nitroacetate (**1b**), organic bases and olefins **36a-j** and **36l-q** were used as supplied. The acrylaldehyde (**36k**) was distilled before using.

Effect of temperature and base on the ratio between Michael adduct **37a-e and cycloadduct **38a-e**. (Table 3-1).**

The conversions and spectroscopic yields reported in Table 3-1 refer to reactions performed in an apparatus where eight reactions were carried out simultaneously. A mixture of ethyl nitroacetate (**1b**) (1.06 mmol), base (0.0424 mmol) and olefin (0.424 mmol) in chloroform (1.4 mL) was kept at 30 °C or 60 °C. After the indicated time, a portion was withdrawn from the reaction mixture, diluted with CDCl₃ (0.6mL) and the ¹H NMR spectrum registered. Integration of the more reliable signals for olefin, adduct and cycloadduct gave the conversion ratio. Compounds **37a-e** and **38a-e** were assumed to be the only products derived from dipolarophiles **36a-e**. The reaction solution, combined with the NMR sample, was concentrated *in vacuo* and then 2',4'-dimethoxyacetophenone (**42**) was added as an internal standard (30 - 50 mg, 0.18 - 0.30 mmol). A portion was withdrawn, dissolved in CDCl₃ (0.6mL) and the ¹H NMR spectrum registered. Integration of 3'- and 5'- protons signals of the internal standard (m, 6.40 - 6.58), signals of 5-H protons of compounds **38a-e** and the more reliable signals of compounds **37a-e** gave the spectroscopic yields. In case of an unclear result, a duplicate experiment was run.

Effect of copper(II)acetate on the ratio between Michael adduct and cycloadduct. (Table 3-2).

The conversions and spectroscopic yields reported in Table 3-2 refer to reactions performed in an apparatus where eight reactions were carried out simultaneously. A mixture of ethyl nitroacetate (**1b**) (1.06 mmol), base (0.0424 mmol), copper (II) acetate (0.0212 mmol) and olefin (0.424 mmol) in chloroform (1.4 mL) was kept at 30 °C or 60 °C. After the indicated time, a portion was withdrawn from the reaction mixture, diluted with CDCl₃ (0.6mL) and the ¹H NMR spectrum registered. Integration of the more reliable signals for olefin, adduct and cycloadduct gave the conversion ratio. Compounds **37a-e** and **38a-e** were assumed to be the only products derived from dipolarophiles **36a-e**. The reaction solution, combined with the NMR sample, was concentrated *in vacuo* and then 2',4'-dimethoxyacetophenone (**42**) was added as an internal standard (30 – 50 mg, 0.18 – 0.30 mmol). A portion was withdrawn, dissolved in CDCl₃ (0.6mL) and the ¹H NMR spectrum registered. Integration of 3'- and 5'-protons signals of the internal standard (m, 6.40 – 6.58), signals of 5-H protons of compounds **38a-e** and the more reliable signals of compounds **37a-e** gave the spectroscopic yields. In case of an unclear result, a duplicate experiment was run.

Effect of DABCO (3) concentration on the reaction products from ethyl nitroacetate (1b) and methyl acrylate (36a). (Figure 3-1)

Reactions were run in a septum-sealed 5mm NMR tube spinning (20 Hz) in the probe of the spectrometer at 60 °C. Three different molar ratios between DABCO (**3**) and methyl acrylate (**36a**), (0.1, 0.075, 0.05) were screened changing the molar amounts of DABCO (**3**).

Preparation of samples. Mother reaction mixtures (kept at -10 °C in a freezer until used) were prepared by dissolving DABCO (**3**) [run a) 9.6 mg; run b) 7.2 mg; run c) 4.8 mg], ethyl nitroacetate (**1b**) (282 mg), methyl acrylate (**36a**) (73 mg) and the internal standard (CH₃)₂SO₂ (**42**) (20 mg) in CDCl₃ (4.04 g, freshly filtered through K₂CO₃). A sample reaction was obtained after transfer of 560 μL of the above solutions in a septum-sealed NMR tube. In case of unclear result a duplicate reaction was run.

Concentration evaluation. An array of ^1H NMR spectra, recorded at intervals of 30 minutes until no further spectral changes were observed, was collected for every run and the concentrations were evaluated by integrating the CH_3 protons signals (2.89 ppm) of the internal standard and the OCH_3 proton signals for **37a** and **38a** (3.70 and 3.79 ppm respectively).

Determination of kinetic profile for different molar ratios between ethyl nitroacetate (**1b**) and methyl acrylate (**36a**). (Figure 3-2).

Reactions were run in a septum-sealed 5mm NMR tube spinning (20 Hz) in the probe of the spectrometer at 60 °C. Four different molar ratios between ethyl nitroacetate (**1b**) and methyl acrylate (**36a**), within in the range of 2.5 : 1 to 1 : 1 were screened changing the molar amounts of ethyl nitroacetate (**1b**).

Preparation of reaction samples. Mother reaction mixtures were prepared by dissolving ethyl nitroacetate (**1b**) [run a) 282 mg; run b) 170 mg; run c) 136 mg; run d) 113 mg] and DABCO (**3**) (9.6 mg) in CDCl_3 (4.04 g, freshly filtered through K_2CO_3). Aliquot portion (1/4) of each mother solution was weighed ⁷¹ [run a) 1.082 g; run b) 1.056 g; run c) 1.047 g; run d) 1.04 g] in a NMR tube containing 1.9 mg of $\text{Cu}(\text{OAc})_2$ and set aside at 60 °C for 30 minutes, thus allowing the salt to get in solution. Methyl acrylate (**36a**, 19 μL) was then added and the tube inserted in the NMR probe maintained at 60 °C.⁷²

Concentration evaluation. An array of ^1H NMR spectra, recorded at intervals of 30 minutes until no further spectral changes were observed, was collected for every run and the concentrations were evaluated by integrating the signal of 4-H of the cycloadduct **38a** (m, 3.47 – 3.51 ppm) and one of the ethylenic proton

⁷¹ Weights were considered more reliable than volumes to ensure a correct reagents ratio. The approximate volumes are obtained considering the density of the reaction sample to that of CDCl_3 (1.500 kg/dm^3): 0.735 mL (run a), 0.717 mL (run b), 0.711 mL (run c), 0.707 mL (run d). Initial **36a** concentrations result: 0.287 M (run a), 0.294 M (run b), 0.297 M (run c), 0.298 M (run d).

⁷² After the addition at room temperature of **36a** the NMR set up usually takes 5 – 10 minutes and this mixing time is not included in the time used for abscissa in Figure 3-2.

signals of methyl acrylate (**36a**) (m, 6.00 - 6.22 ppm). Formation of the cycloadduct **38a** was assumed to be the only process involving the dipolarophile **36a**.

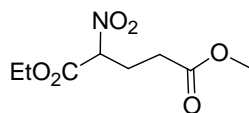
General procedure for the preparation of nitro compounds 37a-e.

Olefin (0.424 mmol) was added to a mixture of ethyl nitroacetate (**1b**) (141 mg, 1.06 mmol) and DABCO (**3**) (4.8 mg, 0.0424 mmol) for **36a-b** and **36d** or DBU (**3b**) (6.5 mg, 0.0424 mmol) for **36c** or N-methyl piperidine (**3c**) (4.2 mg, 0.0424 mmol) for **36e** in chloroform (1.4 mL) and the mixture magnetically stirred in a sealed vessel at 30 °C (unless otherwise stated). After the indicated time the reaction mixture was concentrated and the residue was purified by chromatography on silica gel with the indicated eluant.

General procedure for the preparation of 4,5-dihydroisoxazoles 38a-j (Table 3-3).

Olefin (0.424 mmol) was added to a mixture of copper (II) acetate (3.9 mg, 0.0212 mmol), ethyl nitroacetate (**1b**) (86 mg, 0.636 mmol for **36a-e**; 141 mg, 1.06 mmol for **36f-j**) and N-methylpiperidine (**3c**) (4.2 mg, 0.0424 mmol) (unless otherwise stated) in chloroform (1.4 mL) and the mixture magnetically stirred in a sealed vessel at 60 °C. After the indicated time the reaction mixture was concentrated and the residue was purified by chromatography on silica gel with the indicated eluant.

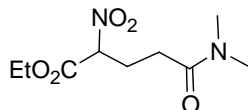
Nitro compound 37a [1-Ethyl 5-methyl 2-nitropentanedioate] (entry 1, Table 3-1):



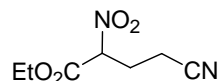
Following the general procedure, methyl acrylate (**36a**) (37 mg, 38 μ L) after 240 h and chromatographic purification (eluting first with hexane and then with

hexane/ethyl acetate 5 : 1, R_f = 0.32) gave **37a** as a clear oil (80 mg, 86 %). ^1H NMR: δ = 1.31 (t, J = 6.0 Hz, 3 H, $\text{CH}_3\text{CH}_2\text{O}$), 2.56 - 2.45 (m, 4 H, CH_2CH and CH_2CO), 3.70 (s, 3 H, CH_3O), 4.29 (q, J = 6.0 Hz, 2 H, $\text{CH}_3\text{CH}_2\text{O}$), 5.33 - 5.26 (m, 1 H, CHNO_2) ppm. ^{13}C NMR: δ = 13.9 (q, CH_3CH_2), 25.3 (t, CH_2CH), 29.4 (t, CH_2CO), 52.0 (q, CH_3O), 63.2 (t, CH_2O), 86.7 (d, CHNO_2), 164.1 (s, C=O), 171.9 (s, C=O) ppm. MS (EI): m/z (%) = 188 (16) $[\text{M} - \text{OCH}_3]^+$, 173 (13) $[\text{M} - \text{NO}_2]^+$, 160 (3) $[\text{M} - \text{CO}_2\text{Me}]^+$, 127 (38), 113 (22), 100 (25), 85 (41), 59 (100) $[\text{CO}_2\text{Me}]^+$. IR (CDCl_3) = ν (tilde) 2986, 2955, 1749 (C=O), 1564 (NO_2), 1439, 1372 (NO_2), 1208 cm^{-1} . Elemental analysis calcd. for $\text{C}_8\text{H}_{13}\text{NO}_6$ (219.19): C 43.84, H 5.98, N 6.39; found: C 43.94, H 5.85, N 6.46

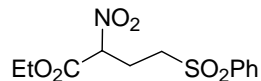
Nitro compound 37b [Ethyl 5-(dimethylamino)-2-nitro-5-oxopentanoate] (entry 5, Table 3-1):



Following the general procedure, *N,N*-dimethylacrylamide (**36b**) (42 mg, 44 μL) after 240 h and chromatographic purification [eluting first with hexane and then gradient with ethyl nitroacetate\hexane from 33 % (1 : 2) to 50% (1 : 1) (R_f = 0.20) gave **37b** as a pale yellow oil (23 mg, 23 %). ^1H NMR: δ = 1.28 (t, J = 6.8 Hz, 3 H, $\text{CH}_3\text{CH}_2\text{O}$), 2.32 - 2.58 (m, 4 H, CH_2CH and CH_2CO), 2.92 (s, 3 H, NCH_3), 2.94 (s, 3 H, NCH_3), 4.25 (q, J = 6.8 Hz, 2 H, $\text{CH}_3\text{CH}_2\text{O}$), 5.40 (dd, J = 5.2 and 9.6 Hz, 1 H, CHNO_2) ppm. ^{13}C NMR: δ = 13.9 (q, CH_3CH_2), 25.7 (t, CH_2CH), 28.3 (t, CH_2CO), 35.4 (s, NCH_3), 36.9 (s, NCH_3), 63.0 (t, CH_2O), 87.2 (d, CHNO_2), 164.5 (s, C=O), 170.2 (s, C=O) ppm. MS (EI): m/z (%) = 232 (2) $[\text{M}]^+$, 185 (14) $[\text{M} - \text{NO}_2]^+$, 140 (18), 113 (25), 72 (100) $[\text{CONMe}_2]^+$. IR (film, neat) = ν (tilde) 2940, 1749 (C=O), 1644 (C=O), 1564 (NO_2), 1439, 1372, 1258 cm^{-1} . Elemental analysis calcd. for $\text{C}_9\text{H}_{16}\text{N}_2\text{O}_5$ (232.23): C 46.55, H 6.94, N 12.06; found: C 46.36, H 6.80, N 11.81.

Nitro compound 37c [Ethyl 4-cyano-2-nitrobutanoate] (entry 9, Table 3-1):

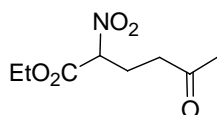
Following the general procedure, acrylonitrile (**36c**) (22.5 mg, 28 μ L, 0.424 mmol), heated at 60 $^{\circ}$ C, after 18 h and chromatographic purification (eluting first with hexane and then with hexane/acetone 5 : 1) (R_f = 0.13) gave **37c** as a clear oil (61 mg, 77%). ^1H NMR: δ = 1.33 (t, J = 8.0 Hz, 3 H, $\text{CH}_3\text{CH}_2\text{O}$), 2.52 – 2.64 (m, 4 H, CH_2CH and $\text{CH}_2\text{C}\equiv\text{N}$), 4.33 (q, J = 8.0 Hz, 2 H, $\text{CH}_3\text{CH}_2\text{O}$), 5.23 – 5.27 (m, 1 H, CHNO_2) ppm. ^{13}C NMR: δ = 13.8 (q, CH_3CH_2), 14.0 (t, $\text{CH}_2\text{C}\equiv\text{N}$), 26.1 (t, CH_2), 63.8 (t, CH_2O), 85.5 (d, CHNO_2), 117.2 (s, $\text{C}\equiv\text{N}$), 163.2 (s, $\text{C}=\text{O}$) ppm. MS (EI): m/z (%) = 187 (<1) $[\text{M}+1]^+$, 159 $[\text{M} - \text{HCN}]^+$, 141 (12) $[\text{M} - \text{OEt}]^+$, 68 (100). IR (film) = ν (tilde) 2986, 2250 ($\text{C}\equiv\text{N}$), 1749 ($\text{C}=\text{O}$), 1564 (NO_2), 1442, 1372 cm^{-1} . Elemental analysis calcd. for $\text{C}_7\text{H}_{10}\text{N}_2\text{O}_4$ (186.17): C 45.16, H 5.41, N 15.05; found: C 45.38, H 5.62, N 14.90.

Nitro compound 37d [Ethyl 4-benzenesulfonyl-2-nitrobutanoate] (entry 13, Table 3-1)

Following the general procedure, phenyl vinyl sulfone (**36d**) (71.5 mg) after 96 h and chromatographic purification (eluting first with petroleum ether and then with petroleum ether/ethyl acetate 3 : 1, R_f = 0.28) gave **37d** as a pale yellow oil (105 mg, 82 %). ^1H NMR: δ = 1.27 (t, J = 7.2 Hz, 3 H, $\text{CH}_3\text{CH}_2\text{O}$), 2.61 (q, J = 7.2 Hz, 2 H, CHCH_2), 3.21 (t, J = 6.8 Hz, 2 H, CH_2SO_2), 4.27 (q, J = 7.2 Hz, 2 H, $\text{CH}_3\text{CH}_2\text{O}$), 5.38 (7, J = 8.0 Hz, 1 H, CHNO_2), 7.58 m, 2 H, Ph-H), 7.68 (m, 1 H, Ph-H), 7.89 (m, 2 H, Ph-H) ppm. ^{13}C NMR: δ = 13.8 (q, CH_3CH_2), 23.7 (t, CHCH_2), 51.6 (t, CH_2SO_2), 63.5 (t, CH_2O), 85.3 (d, CHNO_2), 128.0 (d, 2 C, Ph-C), 129.6 (d, 2 C, Ph-C), 134.3 (d, Ph-C), 138.2 (s, Ph-C), 163.4 (s, $\text{C}=\text{O}$) ppm. MS (EI): m/z (%) = 160 (80) $[\text{M} - \text{SO}_2\text{Ph}]^+$, 132 (44), 77 (100) $[\text{Ph}]^+$. IR (CDCl_3) = ν (tilde) 3070, 2985, 1803, 1752 ($\text{C}=\text{O}$), 1565, 1447, 1308, 1153 cm^{-1} . Elemental analysis

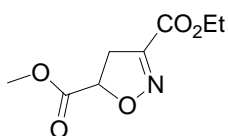
calcd. for $C_{12}H_{15}NO_6S$ (301.32): C 47.83, H 5.02, N 4.65; found: C 47.80, H 5.20, N 4.71.

Nitro compound 37e [2-Nitro-5-oxo-hexanoic acid ethyl ester] (entry 15, Table 3-1):



Following the general procedure, methyl vinyl ketone (**36e**) (30 mg, 35 μ L) after 18 h (60 $^{\circ}$ C) and chromatographic purification (eluting first with petroleum ether and then with petroleum ether/ethyl acetate 5 : 1, R_f = 0.21) gave **37e** as a clear oil (43 mg, 50 %). 1H NMR: δ = 1.28 (t, J = 7.2 Hz, 3 H, CH_3CH_2O), 2.14 (s, 3 H, CH_3CO), 2.38 - 2.46 (m, 2 H, CH_2CH), 2.54 - 2.64 (m, 2 H, CH_2CO), 4.26 (q, J = 7.2 Hz, 2 H, CH_3CH_2O), 5.21 (dd, J = 6.4 and 8.4 Hz, 1 H, $CHNO_2$) ppm. ^{13}C NMR: δ = 13.8 (q, CH_3CH_2), 24.0 (t, CH_2CH), 29.9 (q, CH_3CO), 38.3 (t, CH_2CO), 63.1 (t, CH_2O), 86.7 (d, $CHNO_2$), 164.2 (s, CO_2Et), 205.9 (s, CH_3CO) ppm. MS (EI): m/z (%) = 188 (2) $[M - CH_3]^+$, 160 (1) $[M - COMe]^+$, 156 (2) $[M - HNO_2]^+$, 115 (10), 114 (10), 101 (30), 85 (78), 73 (47), 69 (20), 55 (100). IR ($CDCl_3$) = ν (tilde) 2986, 1751 (C=O), 1719 (C=O), 1564 (N=O), 1371 (N=O) cm^{-1} . Elemental analysis calcd. for $C_8H_{13}NO_5$ (203.19): C 47.29, H 6.45, N 6.89; found: C 47.65, H 6.58, N 6.85.

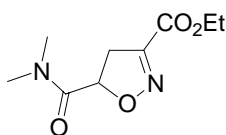
Isoxazoline 38a [4,5-Dihydro-isoxazole-3,5-dicarboxylic acid 3-ethyl ester 5-methyl ester]:



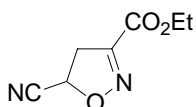
Following the general procedure, methyl acrylate (**36a**) (37 mg, 38 μ L) after 20 h and chromatographic purification (eluting first with hexane and then with hexane/ethyl acetate 4 : 1, R_f = 0.14) gave **38a** as a clear oil (76 mg, 89 %). 1H NMR: δ = 1.34 (t, J = 7.2 Hz, 3 H, CH_3CH_2O), 3.47 - 3.51 (m, 2 H, 4-H), 3.79 (s, 3

H, CH₃O), 4.33 (q, *J* = 7.2 Hz, 2 H, CH₃CH₂O), 5.17 (dd, *J* = 8.2 and 11.4 Hz, 1 H, 5-H) ppm. ¹³C NMR: δ = 14.0 (q, CH₃), 37.6 (t, C-4), 52.9 (q, CH₃O), 62.4 (t, OCH₂), 79.7 (d, C-5), 151.4 (s, C-3), 159.8 (s, CO₂Et), 169.3 (s, CO₂Me) ppm. MS (EI): *m/z* (%) 202^[46] (<1) [M+1]⁺, 201 (<1) [M]⁺, 156 (36) [M - OEt]⁺, 142 (100) [M - CO₂Me]⁺, 70 (60), 59 (93) [CO₂Me]⁺. IR (film) = ν(tilde) 2295, 2958, 1741 (C=O), 1598, 1439 cm⁻¹. Elemental analysis calcd. for C₈H₁₁NO₅ (201.18): C 47.76, H 5.51, N 6.96; found: C 47.36, H 5.65, N 7.27.

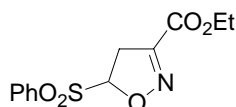
Isoxazoline 38b [ethyl 5-[(dimethylamino)carbonyl]-4,5-dihydro-3-isoxazolecarboxylate]:



Following the general procedure, *N,N*-dimethylacrylamide (**36b**) (42 mg, 44 μL) after 20 h and chromatographic purification (eluting first with hexane and then with hexane/ethyl acetate 1 : 1, *R_f* = 0.15) gave **38b** as a clear oil (92 mg, 100 %). ¹H NMR: δ = 1.33 (t, *J* = 7.0, 3 H, CH₃CH₂O), 2.98 (s, 3 H, NCH₃), 3.15 (s, 3 H, NCH₃), 3.23 (dd, *J* = 11.7 and 17.9 Hz, 2 H, 4-H), 3.99 (dd (s, *J* = 8.0 and 17.9 Hz, 1 H, 4-H), 4.31 (q, *J* = 7.0, 2 H, CH₃CH₂O), 5.41 (dd, *J* = 8.0 and 11.7 Hz, 1 H, 5-H) ppm. ¹³C NMR: δ = 14.0 (q, CH₃), 35.7 (t, C-4), 36.2 (s, NCH₃), 37.2 (s, NCH₃), 62.1 (t, OCH₂), 79.9 (d, C-5), 152.2 (s, C-3), 160.1 (s, C=O), 166.2 (s, C=O) ppm. MS (EI): *m/z* (%) 214 (2) [M]⁺, 184 (14), 169 (3) [M - OEt]⁺, 114 (10), 72 (100) [CONMe₂]⁺. IR (CDCl₃) = ν(tilde) 2984, 2940, 1723 (C=O), 1657 (C=O), 1598, 1566, 1405, 1253 cm⁻¹. Elemental analysis calcd. for C₉H₁₄N₂O₄ (214.219): C 50.46, H 6.59, N 13.08; found: C 50.74, H 6.58, N 13.06.

Isoxazoline 38c [ethyl 5-cyano-4,5-dihydro-3-isoxazolecarboxylate]:

Following the general procedure, acrylonitrile (**36c**) (23 mg, 28 μ L) after 20 h and chromatographic purification (eluting first with hexane and then with hexane/ethyl acetate 4 : 1, R_f = 0.18) gave **38c** as a clear oil^{73,74} (60 mg, 85 %). ¹H NMR: δ = 1.36 (t, J = 7.2, 3 H, $\text{CH}_3\text{CH}_2\text{O}$), 3.60 (d, J = 7.6 Hz, 1 H, 4-H), 3.62 (d, J = 10.8 Hz, 1 H, 4-H), 4.36 (q, J = 7.2, 2 H, $\text{CH}_3\text{CH}_2\text{O}$), 5.36 (dd, J = 7.6 and 10.8 Hz, 1 H, 5-H) ppm. ¹³C NMR: δ = 14.0 (q, CH_3), 39.9 (t, C-4), 62.9 (t, OCH_2), 68.0 (d, C-5), 115.8 (s, CN), 151.1 (s, C-3), 158.9 (s, C=O) ppm. MS (EI): m/z (%) 168 (4) $[\text{M}]^+$, 140 (11) $[\text{M} - \text{HCN}]^+$, 123 (100) $[\text{M} - \text{OEt}]^+$, 113 (49), 110 (10), 96 (18), 95 (10) $[\text{M} - \text{CO}_2\text{Et}]^+$. IR (neat) = ν (tilde) 2986, 2245 ($\text{C}\equiv\text{N}$), 1724 ($\text{C}=\text{O}$), 1602, 1382, 1271, 1124 cm^{-1} . Elemental analysis calcd. for $\text{C}_7\text{H}_8\text{N}_2\text{O}_3$ (168.15): C 50.00, H 4.80, N 16.66; found: C 49.90, H 4.46, N 16.47.

Isoxazoline 38d [ethyl 5-benzenesulphonyl-4,5-dihydro-3-isoxazolecarboxylate]:

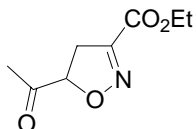
Following the general procedure, ethenesulphonylbenzene (**36d**) (72 mg) after 20 h and chromatographic purification (eluting first with petroleum ether and then with petroleum ether/ethyl acetate 4 : 1, R_f = 0.14) gave **38d** as white solid (99 mg, 83 %). M. p. 87 – 88 °C. ¹H NMR: δ = 1.33 (t, J = 7.2 Hz, 3 H, $\text{CH}_3\text{CH}_2\text{O}$), 3.63 (dd, J = 11.4 and 19.6 Hz, 1 H, 4-H), 3.92 (dd, J = 5.2 and 19.2 Hz, 1 H, 4-H), 4.32 (q, J = 7.2 Hz, 2 H, $\text{CH}_3\text{CH}_2\text{O}$), 5.53 (dd, J = 4.8 and 11.2 Hz, 1 H, 5-H), 7.59 m, 2H, Ph-H), 7.70 (m, 1H, Ph-H), 7.96 (m, 2 H, Ph-H) ppm. ¹³C NMR: δ = 14.0 (q, CH_3), 35.7 (t, C-4), 62.7 (t, OCH_2), 94.0 (d, C-5), 129.4 (d, 2 C, Ph-C), 129.8 (d, 2 C, Ph-C), 134.8 (Ph-C), 134.9 (Ph-C), 152.0 (s, C-3), 158.8

⁷³ Reported b. p. 80 °C (0.1 torr): V. P. Kislyi, A. L. Laikhter, B. I. Ugrak, V. V. Semenov *Russ. Chem. Bull.* **1994**, 43, 98 – 100 [*Izv. Akad. Nauk SSSR Ser. Kim.* **1994**, (1), 103 –105].

⁷⁴ A. Cwik, Z. Hell, A. Fuchs, D. Halmi *Tetrahedron Lett.* **2005**, 46, 6563 – 6566.

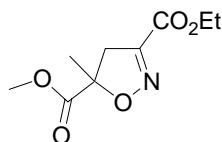
(s, C=O) ppm. MS (EI): m/z (%) 283 (<1) [M]⁺, 238 (2) [M - OEt]⁺, 142 [M - SO₂Ph]⁺, 114 (90), 96 (62), 78 (58), 77(100) [Ph]⁺. IR (CDCl₃) = ν (tilde) 2985, 1726 (C=O), 1604, 1448, 1326, 1269, 1155 cm⁻¹. Elemental analysis calcd. for C₁₂H₁₃NO₅S (283.30): C 50.87, H 4.63, N 4.94; found: C, 50.59, H 4.74, N 5.05.

Isoxazoline 38e [ethyl 5-acetyl-4,5-dihydro-isoxazole-3-isoxazolecarboxylate]:

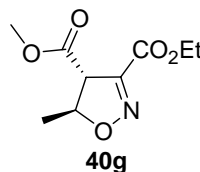
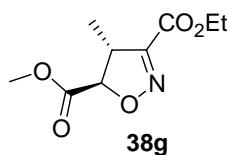


Following the general procedure, methyl vinyl ketone (**36e**) (30 mg, 35 μ L) after 18 h and chromatographic purification (eluting first with petroleum ether and then with petroleum ether/ethyl acetate 5 : 1, R_f = 0.21) gave a mixture of the nitro compound **37e** and the isoxazoline **38e** as a clear oil (72 mg, **37e**: 26%, **38e**: 64 %). Integration of the OCH₃ protons in the ¹H NMR spectrum showed the **37e** : **38e** ratio to be 1 : 2.5. A further chromatographic separation using different eluant (CH₂Cl₂ /hexane 5 : 3) allowed the isoxazoline **38e** (R_f = 0.19)⁷⁵ to be partially separated. ¹H NMR: δ = 1.35 (t, J = 7.2 Hz, 3 H, CH₃CH₂O), 2.31 (s, CH₃CO), 3.34 (dd, J = 12.2 and 18.2 Hz, 1 H, 4-H), 3.49 (dd, J = 7.2 and 18.2 Hz, 1 H, 4-H), 4.34 (q, J = 7.2 Hz, 2 H, CH₃CH₂O), 5.07 (dd, J = 12.2 and 7.2 Hz, 1 H, 5-H) ppm. ¹³C NMR: δ = 13.8 (q, CH₃CH₂), 26.4 (q, CH₃CO), 35.7 (t, C-4), 62.3 (t, OCH₂), 86.0 (d, C-5), 151.6 (s, C-3), 159.7 (s, CO₂Et), 205.1 (s, COMe) ppm. GC-MS (EI): m/z (%) 185 (31) [M]⁺, 142 (40) [M - COMe]⁺, 140 (66), 115 (29), 114 (16), 112 (27) [M - CO₂Et]⁺, 96 (18), 70 (100), 55 (66). IR (CDCl₃) = ν (tilde) 2984, 1726 (C=O), 1595, 1562, cm⁻¹. Elemental analysis calcd. for C₈H₁₁NO₄ (185.18): C 51.89, H 5.99, N 4.57; found: C, 52.10.59, H 5.79, N 7.82.

⁷⁵ C. Ticozzi, A. Zanarotti *Tetrahedron Lett.* **1988**, 29, 6167 - 6170.

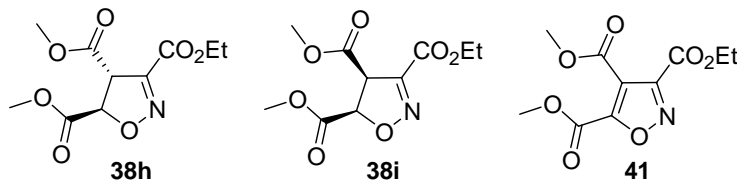
Isoxazoline 38f [5-Methyl-4,5-Dihydro-isoxazole-3,5-dicarboxylic acid 3-ethyl ester 5-methyl ester]:

Following the general procedure, [using N-methylmorpholine (4.3 mg) instead of N-methylpiperidine] the reaction mixture from methyl methacrylate (**36f**) (43 mg, 45, μL) after 65 h was concentrated under reduced pressure, the residue taken up with diethyl ether (20 mL) and the solution washed with aq. 5% HCl (10 mL), water (10 mL), sat. Na_2CO_3 solution (10 mL) and brine (10 mL). The organic layer was then dried over Na_2SO_4 , filtered and concentrated. Chromatographic purification (petroleum ether/ethyl acetate 5 : 1 as eluant, $R_f = 0.23$) gave **38f** as colourless oil (84 mg, 93 %). $^1\text{H NMR}$: $\delta = 1.34$ (t, $J = 7.2$ Hz, 3 H, $\text{CH}_3\text{CH}_2\text{O}$), 1.66 (s, 3 H, 5- CH_3), 3.64 (d, $J = 18.0$ Hz, 1 H, 4-H), 3.70 (d, $J = 18.0$ Hz, 1 H, 4-H), 3.79 (s, CH_3O), 4.32 (q, $J = 7.2$ Hz, 2 H, $\text{CH}_3\text{CH}_2\text{O}$) ppm. $^{13}\text{C NMR}$: $\delta = 14.0$ (q, CH_2CH_3), 23.4 (q, CH_3), 43.4 (t, C-4), 53.1 (t, OCH_3), 62.2 (q, OCH_2), 88.4 (s, C-5), 151.0 (s, C-3), 160.1 (s, CO_2Et), 171.1 (s, CO_2Me) ppm. MS (EI): m/z (%) 216 (<1) $[\text{M}+1]^+$, 215 (<1) $[\text{M}]^+$, 200 (<1) $[\text{M} - \text{Me}]^+$, 170 (35) $[\text{M} - \text{OEt}]^+$, 156 (64) $[\text{M} - \text{CO}_2\text{Me}]^+$, 84 (64), 73 (28) $[\text{CO}_2\text{Et}]^+$, 59 (100) $[\text{CO}_2\text{Me}]^+$. IR (CDCl_3) = $\nu(\text{tilde})$ 2985, 2956, 1740 (C=O), 1595, 1265 cm^{-1} . Elemental analysis calcd. for $\text{C}_9\text{H}_{13}\text{NO}_5$ (215.20): C 50.23, H 6.09, N 6.51; found: C, 50.10, H 6.36, N 6.88.

Isoxazolines 38g [4-Methyl-4,5-Dihydro-isoxazole-3,5-dicarboxylic acid 3-ethyl ester 5-methyl ester] and 40g [5-Methyl-4,5-Dihydro-isoxazole-3,4-dicarboxylic acid 3-ethyl ester 4-methyl ester]:

Following the general procedure, the reaction mixture from (*E*)-methyl crotonate (**36g**) (43 mg, 45 μ L) after 70 h was concentrated under reduced pressure, the residue taken up with diethyl ether (20 mL) and the solution washed with aq. 5% HCl (10 mL), water (10 mL), sat. Na₂CO₃ solution (10 mL) and brine (10 mL). The organic layer was then dried over Na₂SO₄, filtered and concentrated. Chromatographic purification (petroleum ether/ethyl acetate 25 : 1 then petroleum ether/ethyl acetate 10 : 1 as eluant, $R_f = 0.14$) gave a mixture of **38g** and **40g** as colourless oil (69 mg, 76 %). Integration of the 5-H protons in the ¹H NMR spectrum showed the **38g** : **40g** ratio to be 1.8 : 1. Elemental analysis calcd. for C₉H₁₃NO₅ (215.20): C 50.23, H 6.09, N 6.51; found: C, 50.19, H 6.06, N 6.88. **Isoxazoline 38g**. ¹H NMR: $\delta = 1.34$ (t, $J = 6.8$ Hz, 3 H, CH₃CH₂O), 1.41 (d, $J = 7.2$ Hz, 3 H, CH₃), 3.72 - 3.76 (m, 1 H, 4-H), 3.77 (s, 3 H, CH₃O), 4.32 (q, $J = 6.8$ Hz, 2 H, CH₃CH₂O), 4.73 (d, $J = 6.0$ Hz, 1 H, 5-H) ppm. ¹³C NMR: $\delta = 14.0$ (q, CH₃), 17.5 (q, CH₃), 46.3 (t, C-4), 52.8 (q, CH₃O), 62.2 (t, OCH₂), 86.4 (d, C-5), 154.6 (s, C-3), 159.6 (s, CO₂Et), 169.4 (s, CO₂Me) ppm. GC-MS (EI): m/z (%) 216 (<1) [M+1]⁺, 170 (12) [M - OEt]⁺, 156 (38) [M - CO₂Me]⁺, 128 (4), 84 (34), 59 (68) [CO₂Me]⁺, 56 (100). **Isoxazoline 40g**. ¹H NMR: $\delta = 1.33$ (t, $J = 7.2$ Hz, 3 H, CH₃CH₂O), 1.46 (d, $J = 6.4$ Hz, 3 H, CH₃), 3.74 (s, 3 H, CH₃O), 3.90 (d, $J = 7.6$ Hz, 2 H, 4-H), 4.33 (q, $J = 7.2$ Hz, 2 H, CH₃CH₂O), 4.96 - 5.04 (m, 1 H, 5-H) ppm. ¹³C NMR: $\delta = 14.0$ (q, CH₃), 20.4 (q, CH₃), 58.2 (t, C-4), 53.0 (q, CH₃O), 62.3 (t, OCH₂), 84.6 (d, C-5), 149.1 (s, C-3), 159.9 (s, CO₂Et), 169.0 (s, CO₂Me) ppm. GC-MS (EI): m/z (%) 216 (<1) [M+1]⁺, 200(<1) [M - Me]⁺, 184 (2) [M - OMe]⁺, 170 (4) [M - OEt]⁺, 156 (8) [M - CO₂Me]⁺, 142 (4) [M - CO₂Et]⁺, 128 (44), 116 (52), 101 (36), 100 (54), 59 (100) [CO₂Me]⁺. IR (CDCl₃) = ν (tilde) 2984, 2956, 1742 (C=O), 1591, 1438, 1251 cm⁻¹.

Reaction of dimethyl maleate with ethyl nitroacetate. Isoxazolines 38h [(4*S*,*R*)-(5*R*,*S*)-4,5-Dihydro-isoxazole-3,4,5-tricarboxylic acid 3-ethyl ester 4,5-dimethyl ester], isoxazolines 38i [(4*S*,*R*)-(5*S*,*R*)-4,5-Dihydro-isoxazole-3,4,5-tricarboxylic acid 3-ethyl ester 4,5-dimethyl ester] and

isoxazole 41 [Isoxazole-3,4,5-tricarboxylic acid 3-ethyl ester 4,5-dimethyl ester]:

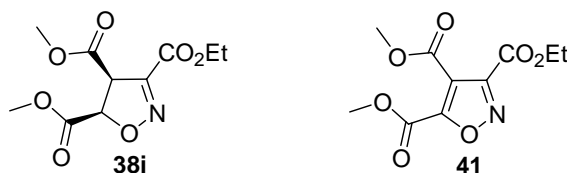
Following the general procedure dimethyl maleate (**36h**) (61 mg, 53 μ L) after 24 h and chromatographic purification (eluting first with hexane and then with hexane /ethyl acetate 5 : 1) gave the isoxazole **41** (R_f = 0.29, 8 mg, 7%) and the isoxazoline **38i** as clear oil (R_f < 0.1, 87 mg, 79%). GC-MS analysis showed the presence of less than 10% of the isomer **38h**.

Isoxazoline 38h. Identified signals. $^1\text{H NMR}$: 3.74 (s, 3 H, CH_3O), 3.79 (s, 3 H, CH_3O), 5.41 (d, J = 9.9 Hz, 1 H, 5-H) 4.64 (d, 1 H, J = 9.9 Hz, 4-H) ppm. $^{13}\text{C NMR}$: δ = 14.2 (q, CH_3), 53.0 (q, CH_3O), 53.2 (q, CH_3O), 55.4 (d, C-4), 62.2 (t, OCH_2), 82.5 (d, C-5), 150.7 (s, C-3), 159.0 (s, CO_2Et), 166.7 (s, CO_2Me), 166.8 (s, CO_2Me) ppm. GC MS (EI): m/z (%) 260 (<1) $[\text{M}+1]^+$, 228 (2), 200 (10), 172 (4), 156 (16), 128 (33), 100 (24), 59 (100). **Isoxazoline 38i.** $^1\text{H NMR}$: δ = 1.33 (t, J = 7.4 Hz, 3 H, $\text{CH}_3\text{CH}_2\text{O}$), 3.78 (s, 3 H, CH_3O), 3.81 (s, 3 H, CH_3O), 3.90 (d, J = 7.6 Hz, 2 H, 4-H), 4.34 (q, J = 7.4 Hz, 2 H, $\text{CH}_3\text{CH}_2\text{O}$), 4.63 (d, 1 H, J = 6.2 Hz, 4-H), 5.36 (d, J = 6.2 Hz, 1 H, 5-H) ppm. $^{13}\text{C NMR}$: δ = 14.1 (q, CH_3), 53.4 (q, CH_3O), 53.5 (q, CH_3O), 55.2 (d, C-4), 62.2 (t, OCH_2), 83.4 (d, C-5), 148.9 (s, C-3), 158.8 (s, CO_2Et), 167.7 (s, CO_2Me), 167.8 (s, CO_2Me) ppm. GC MS (EI): m/z (%) 260 (<1) $[\text{M}+1]^+$, 228 (2), 214 (4), 200 (22), 172 (12), 100 (32), 101 (26), 59 (100) $[\text{CO}_2\text{Me}]^+$. IR (CDCl_3) = ν (tilde) 2985, 2956, 1748 (C=O), 1597, 1437 cm^{-1} . Elemental analysis calcd. for $\text{C}_{10}\text{H}_{13}\text{NO}_7$ (259.21): C 46.34, H 5.06, N 5.40; found: C 46.17, H 5.39, N 5.78.

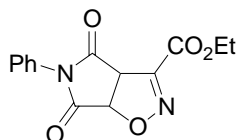
Isoxazole 41. $^1\text{H NMR}$: δ = 1.38 (t, J = 7.2 Hz, 3 H, CH_2CH_3), 3.94 (s, 3 H, OCH_3), 3.98 (s, 3 H, OCH_3), 4.43 (q, J = 7.2 Hz, 2 H, CH_2CH_3) ppm. $^{13}\text{C NMR}$: δ = 13.9 (q, CH_2CH_3), 53.4 (q, OCH_3), 53.6 (q, OCH_3), 63.1 (t, CH_2CH_3), 117.8, (s, C-4), 154.4 (s), 155.5 (s), 157.9 (s, CO_2Me), 158.9 (s, CO_2Et), 160.1 (s, CO_2Me) ppm. MS (EI): m/z (%) 257 (<1) $[\text{M}]^+$, 226 (14) $[\text{M} - \text{OMe}]^+$, 198 (4) $[\text{M} - \text{CO}_2\text{Me}]^+$, 126 (65), 59 (100) $[\text{CO}_2\text{Me}]^+$. IR (CDCl_3) = ν (tilde) 2986, 2956, 1747 (C=O), 1608, 1478, 1434

cm⁻¹. C₁₀H₁₁NO₇ (257.20): calcd. C 46.70, H 4.31, N 5.45; found C 46.64, H 4.70, N 5.69.

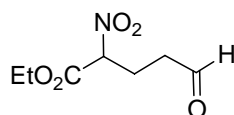
**Reaction of Dimethyl fumarate (36i) with ethyl nitroacetate (1b).
Isoxazoline 38i and isoxazole 41:**



Dimethyl fumarate (**36i**) (61.2 mg, 0.424 mmol) was added to a mixture of copper (II) acetate (3.9 mg, 0.0212 mmol,) ethyl nitroacetate (**1b**) (141 mg, 1.06 mmol) and 1-methylpiperidine (**3c**) (4.2 mg, 0.0424 mmol) in chloroform (1.4 mL) and the mixture magnetically stirred in a sealed vessel at 60 °C. After 69 h a second amount of copper (II) acetate (3.9 mg, 0.0212 mmol) and 1-methylpiperidine (**3c**) (4.2 mg, 0.0424 mmol) was added and the reaction mixture heated for 62 h longer. The reaction mixture was concentrated and the residue purified by chromatography on silica gel eluting first with hexane and then with hexane / ethyl acetate 5 : 1. A first fraction ($R_f = 0.29$) containing the isoxazole **41** (65 mg, 60 %) was followed by a second fraction containing the isoxazoline **38i** [$R_f < 0.1$, 33 mg] as clear oil in 30 % yield. GC-MS analysis of the latter fraction showed the presence of less than 10% of isomer **38h**. **Isoxazoline 38i**. Spectroscopic data are identical to those reported above for compound **38i** obtained from dimethyl maleate (**36h**). Elemental analysis calcd. for C₁₀H₁₃NO₇ (259.21): C 46.34, H 5.06, N 5.40; found: C 46.64, H 4.70, N 5.69. **Isoxazole 41**. Spectroscopic data are identical to those reported above for compound **41** obtained from dimethyl maleate (**36h**). Elemental analysis calcd. for C₁₀H₁₁NO₇ (257.20): C 46.70, H 4.31, N 5.45; found: C 46.95, H 4.62, N 5.72.

Isoxazoline 38j [4,5-Dihydro-isoxazole-3,4,5-tricarboxylic acid 3-ethyl ester-4,5-dimethyl ester]:

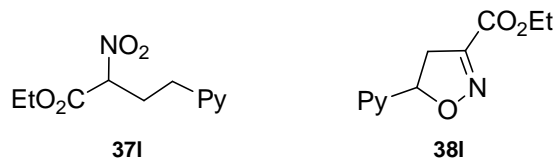
Following the general procedure N-Phenylmaleimide (**36j**) (74 mg) after 64 h and chromatographic purification (eluting first with hexane and then with hexane / ethyl acetate 3 : 1, $R_f = 0.11$) gave **38j** as yellowish powder (87 mg, 71 %). M. p. 174 - 175 °C. $^1\text{H NMR}$: $\delta = 1.38$ (t, $J = 7.2$ Hz, 3 H, $\text{CH}_3\text{CH}_2\text{O}$), 4.38 - 4.46 (m, 2 H, $\text{CH}_3\text{CH}_2\text{O}$), 4.86 [d, $J = 10.0$ Hz, C(=N)CH], 5.68 (d, $J = 10.0$ Hz, OCH), 7.25 - 7.28 (m, 2 H, Ph-H), 7.38 - 7.50 (m, 3 H, Ph-H), ppm. $^{13}\text{C NMR}$: $\delta = 14.0$ (q, CH_2CH_3), 53.7 (d, C(=N)CH), 63.1 (t, $\text{CH}_3\text{CH}_2\text{O}$), 82.0 (d, OCH), 126.1 (d, 2 C, Ph-C), 129.4 (d, 2 C, Ph-C), 130.6 (s, Ph-C), 147.7 (s, C=N), 158.2 (s, CO_2Et), 168.9 (s, NCO), 169.2 (s, NCO) ppm. MS (EI): m/z (%) 288 (12) $[\text{M}]^+$ 243 (2), 119 (100), 91 (16), 77 (6). IR (CDCl_3) = nu (tilde) 1737 (C=O), 1584, 1498, 1378 cm^{-1} . Elemental analysis calcd. for $\text{C}_{14}\text{H}_{12}\text{N}_2\text{O}_5 \cdot \text{H}_2\text{O}$ (288.26): C 58.33, H 4.20, N 9.72; found: C 58.73 H 4.26, N 9.36.

Nitro compound 37k [2-Nitro-5-oxo-pentanoic acid ethyl ester]:

Acrylaldehyde (**36k**; 0.424 mmol) was added to a mixture of copper (II) acetate (3.9 mg, 0.0212 mmol), ethyl nitroacetate (**1b**; 141 mg, 1.06 mmol) and DABCO (**3**) (4.8 mg, 0.0424 mmol) in chloroform (1.4 mL) and the mixture magnetically stirred in a sealed vessel at 10, 30 and 60 °C. After 20 h the reaction mixture was concentrated and the residue was purified by chromatography on silica gel (diethyl ether/ hexane 1:1, $R_f=0.23$, clear oil, 12 mg). $^1\text{H NMR}$ (200 MHz, CDCl_3): $\delta = 1.2$ -1.5 (m, 3 H, CH_3), 2.5 (m, 2 H, CH_2), 2.73 (m, 2 H, CH_2), 4.4 (m, 2 H, CH_2O), 5.25 (m, 1 H, CHNO_2), 9.78 (s, 1 H, CHO) ppm. MS (EI, 70 eV): m/z

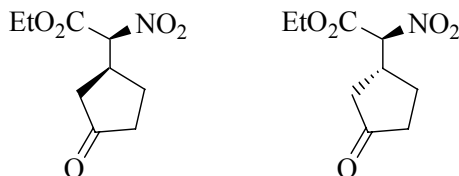
(%) = 144 (6) [M - OEt]⁺, 114 (38), 97 (39), 85 (69), 73 (48), 69 (97), 55 (100). IR (CDCl₃): ν = 2986, 1749 (CHO and C=O), 1564 (NO₂), 1260 (NO₂) cm⁻¹.

Nitro compound 371 [2-Nitro-4-pyridin-4-yl-butylric acid ethyl ester] and **isoxazoline 381** [5-Pyridin-4-yl-4,5-dihydro-isoxazole-3-carboxylic acid ethyl ester]:



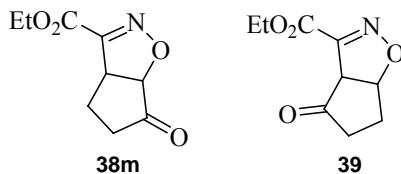
4-Vinylpyridine (**361**; 0.424 mmol) was added to a mixture of copper (II) acetate (3.9 mg, 0.0212 mmol), ethyl nitroacetate (**1b**; 141 mg, 1.06 mmol) and DABCO (4.8 mg, 0.0424 mmol) in chloroform (1.4 mL) and the mixture magnetically stirred in a sealed vessel at 60 °C. After 19 h the reaction mixture was concentrated and before chromatographic purification the crude material was dissolved in dichloromethane (10 mL), washed with water (5 mL x 3) and dried (sodium sulphate); then the residue was purified by chromatography on silica gel (ethyl acetate/ petroleum ether 1:1, R_f=0.30, 31 mg). **Nitro compound 371**: ¹H NMR (400 MHz, CDCl₃): δ = 1.2-1.5 (m, 3 H, CH₃), 2.38-2.81 (m, 4 H, CH₂CH₂), 4.3 (q, 2 H, CH₂O), 5.08 (m, 1 H, CHNO₂), 7.16 (d, 2 H, Py), 8.55 (s br, 2H, Py) ppm. ¹³C NMR (100.58 MHz, CDCl₃): δ = 13.8 (q, CH₃), 30.1 (t, CH₂CH₂), 30.3 (t, CH₂CH₂), 63.0 (t, CH₂O), 87.3 (d, CHNO₂), 123.8 (d, 2 C, Py), 147.5 (s, Py), 150.1 (d, 2 C, Py), 164 (s, C=O) ppm. **Isoxazoline 381**: ¹H NMR (400 MHz, CDCl₃): δ = 1.2-1.5 (m, 3 H, CH₃), 3.63 (m, 2H, H-4), 4.3 (q, 2 H, CH₂O), 5.21 (m, 1 H, H-5), 7.31 (d, 2 H, Py), 8.62 (d, 2H, Py) ppm.

Nitro compound 37m [Nitro-(3-oxo-cyclopentyl)-acetic acid ethyl ester]:



Cyclopent-2-en-1-one (**36m**; 0.424 mmol) was added to a mixture a mixture of copper (II) acetate (3.9 mg, 0.0212 mmol), ethyl nitroacetate (**1b**; 141 mg, 1.06 mmol) and NMP (4.2 mg, 0.0424 mmol) in chloroform (1.4 mL) and the mixture magnetically stirred in a sealed vessel at 60 °C. After 137 h the reaction mixture was concentrated and the residue was purified by chromatography on silica gel (ethyl acetate/ petroleum ether 1:5, R_f=0.22, clear oil 20 mg, 22%). ¹H NMR (400 MHz, CDCl₃): δ = 1.25-1.38 (m, 3 H, CH₃), 1.68-1.91 (m, 2 H, CH₂CH₂), 2.00-2.65 (m, 4H, CH₂CO), 3.17 (m, 1H, CHCH₂), 4.3 (m, 2 H, CH₂O), 5.08 (dd, 1 H, CHNO₂) ppm. MS (EI, 70 eV): **a**) *m/z* (%) = 198 (<1), 139 (12), 111 (17), 95 (55), 83 (49), 71 (43), 67 (64), 55 (100); **b**) *m/z* (%) = 167 (1), 139 (9), 111 (23), 99 (25), 95 (60), 83 (44), 71 (65), 67 (56), 55 (100).

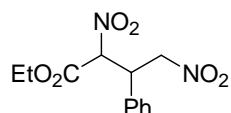
Isoxazolines 38m [6-Oxo-4,5,6,6a-tetrahydro-3aH-cyclopenta[d]isoxazole-3-carboxylic acid ethyl ester] and 39 [4-Oxo-4,5,6,6a-tetrahydro-3aH-cyclopenta[d]isoxazole-3-carboxylic acid ethyl ester]:



Cyclopent-2-en-1-one (**36m**; 0.424 mmol) was added to a mixture a mixture of copper (II) acetate (3.9 mg, 0.0212 mmol), ethyl nitroacetate (**1b**; 141 mg, 1.06 mmol) and NMP (4.2 mg, 0.0424 mmol) in chloroform (1.4 mL) and the mixture magnetically stirred in a sealed vessel at 60 °C. After 137 h the reaction mixture was concentrated and the residue was purified by chromatography on silica gel (ethyl acetate/ petroleum ether 1:5, R_f=0.19, yellowish oil 7 mg, 8%). ¹H NMR

(200 MHz, CDCl₃): δ = 1.18-1.25 (m, 3 H, CH₃), 2.42 (m, 4 H, CH₂), 4.3 (m, 2 H, CH₂O), 4.37 (m, 1 H, H-4), 5.61 (m, 1 H, H-5) ppm. MS (EI, 70 eV): m/z (%) = 197 (7) [M]⁺, 168 (1) [M-Et]⁺, 152 (22) [M-OEt]⁺, 114 (19), 96 (60), 70 (74), 68 (83), 55 (100).

Nitro compound 37n [Nitro 2,4-Dinitro-3-phenyl-butyric acid ethyl ester]:



2-Nitrovinylbenzene (**36n**; 0.424 mmol) was added to a mixture a mixture of copper (II) acetate (3.9 mg, 0.0212 mmol), ethyl nitroacetate (**1b**; 141 mg, 1.06 mmol) and NMP (4.2 mg, 0.0424 mmol) in chloroform (1.4 mL) and the mixture magnetically stirred in a sealed vessel at 60 °C. After 16 h the reaction mixture was concentrated and the residue was purified by chromatography on silica gel (ethyl acetate/ petroleum ether 1:8, R_f=0.23, clear oil 61 mg, 59%). ¹H NMR (400 MHz, CDCl₃): δ = 1.13 (t, J = 7 Hz, 3 H, CH₃), 1.26-1.35 (m, 3 H, CH₃), 4.17 (q, J = 7.2 Hz, 2H, CH₂O), 4.34 (q, J = 5.8 Hz, 2H, CH₂), 4.53 (m, 2 H, CH₂), 4.96 (m, 4 H), 5.54 (dd, J = 15 and 8 Hz, 2 H, CHNO₂) ppm. MS (EI, 70 eV): m/z (%) = 236 (2), 190 (17) [M - 2NO₂]⁺, 189 (42), 161 (58), 144 (11), 131 (33), 115 (100), 104 (43), 91 (71), 77 (49). IR (CDCl₃): ν = 3069, 3034, 2927, 1752 (C=O), 1563 (NO₂), 1375, 1272 (NO₂) cm⁻¹.

Chapter 4

4. An asymmetric approach to 1,3-dipolar cycloaddition

4.1. Introduction

Isoxazole derivatives are not only useful as basic backbones of biologically active substances such as pharmaceuticals and agrochemicals, but are also useful precursors to fine chemicals. Cleavage of the oxygen–nitrogen bond in the ring leads to the formation of a variety of chain possibly chiral compounds. It is important to develop methodologies for the asymmetric synthesis of these products; the preparation of 4,5-dihydroisoxazoles as pure enantiomers is a problem faced by many groups interested in the synthesis of bioactive chiral compounds. Three different types of selectivity must be considered in 1,3-dipolar cycloaddition reactions: regioselectivity, diastereoselectivity, and enantioselectivity. The regioselectivity is controlled by both steric

and electronic effects.⁷⁶ While many papers focus on diastereoselective syntheses of the isoxazoline ring,⁷⁷ only a few examples are found on the preparation of these heterocycles through an enantioselective process.^{78,79,80,81,82}

4.1.1. Cycloadditions of Nitrile Oxide

Nitrile oxides are key reaction intermediates in the synthesis of isoxazole and isoxazoline derivatives by 1,3-dipolar cycloaddition. As mentioned before, nitrile oxides are very reactive compounds, they are commonly employed by the *in situ* technique⁸³, from hydroximoyl chlorides² or by dehydration of nitroalkanes by means of phenyl isocyanate and triethylamine. From the 1980s, many efforts were directed toward asymmetric induction of nitrile oxide cycloaddition to give pure (dia) stereoisomeric isoxazolines, and their acyclic products derived, for the synthesis of natural products. Huisgen and co-workers evaluated the influence of different olefin substituents on the cycloaddition of nitrile oxide, in particular of benzonitrile oxide in diethyl ether.⁸⁴ The reactivity of the dipolarophile is increased by the presence of both electron-donating and -withdrawing substituents, and

⁷⁶ a) K. N. Houk, K. Yamaguchi in *1,3-Dipolar Cycloaddition Chemistry*; Padwa, A. (Ed.), Wiley, New York, 1984; Vol. 2, p. 407. b) K. N. Houk, *Top. Curr. Chem.* **1979**, 79, 1.

⁷⁷ J.-P. G. Seerden, M. M. M. Kuypers, H. W. Scheeren *Tetrahedron: Asymmetry* **1995**, 6, 1441.

⁷⁸ J.-P. G. Seerden, M. M. M. Boeren, H. W. Scheeren *Tetrahedron* **1997**, 53, 11843.

⁷⁹ M. J. Meske *Prakt. Chem.* **1997**, 339, 426.

⁸⁰ M. Takasu, H. Yamamoto *Synlett* **1990**, 194.

⁸¹ K. B. Simonsen, K. V. Gothelf, K. A. Jørgensen *J. Org. Chem.* **1999**, 63, 7536.

⁸² K. B. Jensen, M. Roberson, K. A. Jørgensen *J. Org. Chem.* **2000**, 65, 9080.

⁸³ R. Huisgen, W. Mack, *Tetrahedron Lett.*, **1961**, 583; *Chem. Ber.*, **1972**, 105, 2805.

⁸⁴ K. Bast, M. Christl, R. Huisgen, W. Mack, *Chem. Ber.*, **1973**, 106, 3312.

the effect of conjugation appears to be stronger than the inductive one.⁸⁵ The approach of the nitrile oxide to the π -bond can occur from both olefinic enantiofaces with two regioisomeric modes of reaction (see Figure 4-1).

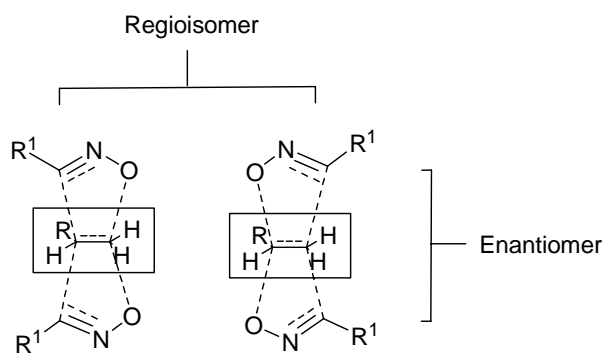


Figure 4-1

The cycloaddition to monosubstituted alkenes can lead to 4 products, two regioisomers, the 4- and/or 5-substituted 2-isoxazoline, in the two enantiomeric forms. Actually reactions with these alkenes give the 5-substituted isomer with an almost complete regioselectivity.⁸⁶ Change of the substituents in the dipole has a small effect on the regioselectivity.

The cycloaddition of nitrile oxides to 1,2-disubstituted alkenes may give mixtures of two regioisomers; the product ratio will depend on the substituents present on the olefin.

In general, to achieve asymmetric induction there are three methods: (1) using chiral dipolarophiles; (2) attaching a chiral auxiliary to the

⁸⁵ R. Huisgen in *1,3-Dipolar Cycloaddition Chemistry*, Vol. 1, A. Padwa, ed. Wiley-Interscience, New York, **1984**, Chapter 1, p. 1.

⁸⁶ a) Ch. Grundmann, P. Grünanger, *The Nitrile Oxides*, Springer-Verlag Berlin-Heidelberg-NewYork **1971**. b) P. Caramella, P. Grünanger, in *1,3-Dipolar Cycloaddition Chemistry*, Vol. 1, A. Padwa, ed. Wiley-Interscience, New York, **1984**, Chapter 3, p. 291. c) P. Grünanger, P. Vita-Finzi, "Isoxazoles" in *The Chemistry of Heterocyclic Compounds*, Vol. 49, Part. 1, E. C. Taylor and A. Weissberger, ed. Wiley, New York, **1991**.

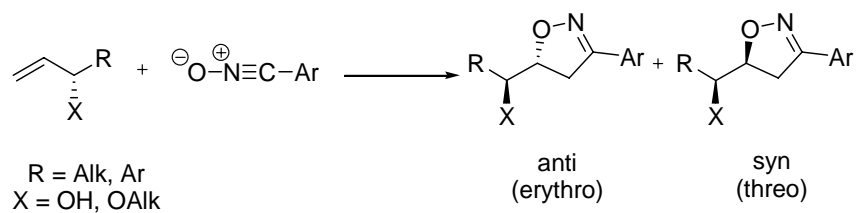
dipolarophile; and (3) employing a chiral catalyst, usually a Lewis acid or a metal complex. The first and the second method have been the most commonly employed for achieving asymmetric induction in the cycloadditions during the past decade. However, the use of chiral catalytic Lewis acids has shown widespread utility, with several excellent commercially available catalysts.

4.1.2. Nitrile Oxide Cycloadditions with chiral dipolarophiles

With chiral monosubstituted alkenes the cycloaddition preferentially occurs on the face of the alkene that is less sterically shielded in the transition state, and the stereoselectivity increases with the size of the R group attached to the pro-chiral center.⁸⁷ Based on these results, Houk et al.⁸⁷ proposed a transition state model involving an inside-alkoxy effect, in order to account for the stereoselectivities of nitrile oxide cycloaddition to a variety of alkenes that contain allylic substitution bearing hydroxyl, alkoxy, or related units. For example, chiral allylic ethers produce preferably the anti (erythro) product, regardless of the nature of the substituent on the allylic oxygen.⁸⁸ Allylic alcohols tend to favour the syn (threo) product, but with low stereoselectivity (Scheme 4-1).

⁸⁷ K. N. Houk, S. R. Moses, Y.-D. Wu, N. G. Rondan, V. Jäger, R. Schohe, and F. R. Fronczek, *J. Am. Chem. Soc.*, **1984**, *106*, 3880.

⁸⁸ a) D. P. Curran in *Advances in Cycloaddition*, Vol. 1, D. P. Curran, ed. Jai Press Inc., Connecticut, **1988**, pp. 129-189. b) A. P. Kozikowski, *Acc. Chem. Res.*, **1984**, *17*, 410. c) V. Jäger, H. Grund, V. Buss, W. Schwab, I. Müller, R. Schohe, R. Franz, and R. Ehrler, *Bull. Soc. Chim. Belg.*, **1983**, *92*, 1039.



Scheme 4-1.

Furthermore examples of reactions are present with cyclic allylic alcohols, which provide useful yields and high levels of diastereocontrol.⁸⁹ Authors believe that stereocontrol is under the exclusive dictate of the allylic stereocenter; a key limitation observed is that cyclohexenols are unreactive.

4.1.3. Cycloadditions of Nitrile Oxide with achiral olefins bearing chiral auxiliaries

The use of chiral auxiliaries to induce (or control) diastereoselectivity in the cycloaddition of nitrile oxides with achiral alkenes to give 5-substituted isoxazolines has been investigated by a number of groups.

The most common chiral dipolarophiles are acrylates, which have been classified into three categories, types I, II, and III (Figure 4-2). Type I reagents are chiral acrylates that incorporate the chiral group in a simple and straightforward manner. Type II reagents are those in which the chiral group is, in comparison with type I, one atom closer to the double bond. This type of compound typically requires a more complex synthesis and the subsequent removal of the stereogenic centre present in the compound. Furthermore, the recycling of the chiral group may be

⁸⁹ N. Becker, E. M. Carreira *Org. Lett.*, 2007, 9, 3857-3858.

cumbersome. Type III reagents are acrylamide compounds bearing a chiral auxiliary connected via an amide linkage. This type of reagent exhibits high activity due to the positive electronic effect at the nitrogen atom of the corresponding iminium salt.

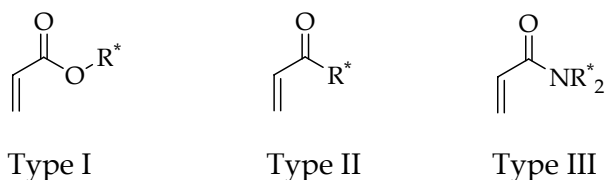


Figure 4-2. Three types of chiral dipolarophiles.

Concerning acrylates, or reagents of type I, several chiral auxiliaries such as menthol derivatives, camphor derivatives,⁹⁰ and oxazolidinones⁹¹ are available. Carbohydrate compounds have also been reported as chiral auxiliaries, although the stereoselectivity was not good.⁹² Chiral α,β -unsaturated N-acyloxazolidinones have been also regarded as a complement for dipolarophile reagents of type I.

4.1.4. Cycloadditions of Nitrile Oxides with achiral dipolarophiles with chiral metal chelates

Perhaps, the most attractive method of introducing enantioselectivity in cycloaddition is to use a chiral catalyst in the form of a Lewis acidic metal complex. In recent years, this area of research has shown the greatest progress with the introduction of many excellent catalytic processes. Quite a number of ligand-metal combinations have been

⁹⁰ Tanaka, K.; Uno, H.; Osuga, H.; Suzuki, H. *Tetrahedron Asymmetry* **1993**, *4*, 629.

⁹¹ Evans, D. A.; Chapman, K. T.; Bisaha, J. *J. Am. Chem. Soc.*, **1988**, *110*, 1238.

⁹² Ferreira, M. L. G.; Pinheiro, S.; Perrone, C. C.; Costa, P. R. R.; Ferreira, V. F. *Tetrahedron Asymmetry*, **1998**, *9*, 2671.

evaluated for their potential as chiral catalysts in these reactions, but the metal-catalyzed asymmetric 1,3-dipolar cycloaddition reactions have only been explored for the five types of dipole shown in Figure 4-3.

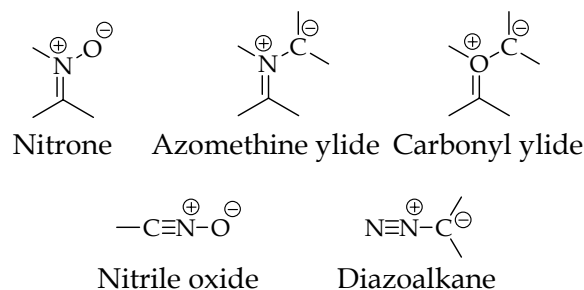


Figure 4-3.

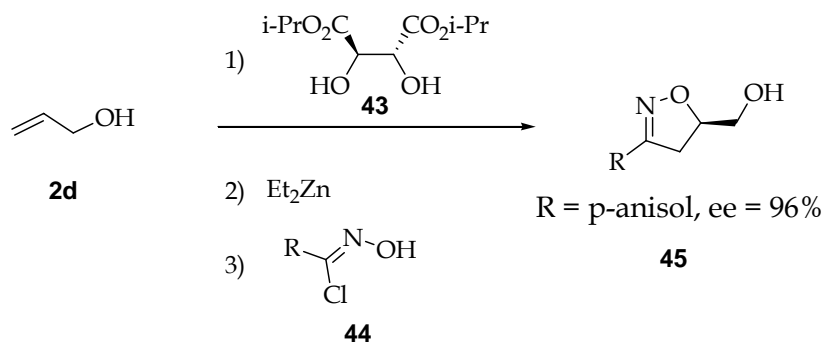
Most studies in this field have been on nitrones. One reason is probably because nitrones are readily available compounds that can be obtained from aldehydes, amines, imines, and oximes.⁹³ On the other hand nitrile oxides are, along with nitrones, the most commonly applied 1,3-dipole for the synthesis of five-membered heterocyclic rings.⁹³ They are easily available from aldoximes or primary nitro compounds, but most nitrile oxides must be prepared in situ, because of their high reactivity and rapid dimerization. The high reactivity of nitrile oxides is probably the reason for little catalytic control of this reaction.⁹⁴ However, in contrast with the Diels–Alder reaction, it is not easy to accomplish good stereoselectivity using nitrile oxide cycloaddition reactions and chiral metal chelates; in fact, this type of approach has been mainly exploited with nitrile oxides and allylic alcohols or acrylamides. The main drawback in controlling the reactions is that the use of Lewis acid

⁹³ a) Torssell, K. B.G. *Nitrile Oxides, Nitrones and Nitronates in Organic Synthesis*; VCH, Weinheim, 1988. b) Tufariello, J. J. In *1,3-Dipolar Cycloaddition Chemistry*; Padwa, A. (Ed.), Wiley, New York, 1984; Vol. 2, p. 83.

⁹⁴ Gothelf, K.V.; Jørgensen, K. A. *Chem. Rev.* 1998, 98, 863.

usually deactivates the nitrile oxide, stopping the reaction. In addition, the presence of a coordinative amine base necessary for the generation of nitrile oxide decreases the effectiveness of the Lewis acid. This inconvenient effect was overcome by utilizing magnesium salts.⁹⁵

The first, and so far only, metal-catalyzed asymmetric 1,3-dipolar cycloaddition reaction of nitrile oxides with alkenes was studied by Ukaji et al.^{96,97} Upon treatment of allyl alcohol (**2d**) with diethyl zinc and (R,R)-diisopropyltartrate (**43**), followed by the addition of diethyl zinc and substituted hydroximoyl chlorides (**44**), the isoxazolidines (**45**) are formed with impressive enantioselectivities of up to 96% enantiomeric excess (Scheme 4-2).⁹⁶



Scheme 4-2.

In Table 4-1 some examples are shown from the recent literature about the previous illustrated procedure and the achieved enantiomeric excess.

⁹⁵ a) S. Kanemasa, K. Okuda, H. Yamamoto, and S. Kaga, *Tetrahedron Lett.*, **1997**, 38, 4095.

b) K. V. Gothelf and K. A. Jørgensen, *Chem. Rev.*, **1998**, 98, 863.

⁹⁶ Shimizu, M.; Ukaji, Y.; Inomata, K. *Chem. Lett.* 1996, 455.

⁹⁷ Ukaji, Y.; Sada, K.; Inomata, K. *Chem. Lett.* 1993, 1847.

Table 4-1. Examples from the recent literature about enantioselectivity in cycloaddition between hydroximoyl chloride and allyl alcohol.

Entry	R/R ¹	Ligand	L.A./Conditions	ee %	Ref
1	Ar, t-Bu/H	 (R,R)- diisopropyltartrate	Et ₂ Zn/Dioxane, CHCl ₃ , 0 °C	90- 93	98, 99
2	Ar, t-Bu/ Me, CO ₂ Et	 (R,R)- diisopropyltartrate	Et ₂ Zn/Dioxane, CHCl ₃ , 0-25 °C	88- 98	100
3	Ar/Et	 R-(+)-Binol	Yb(OTf) ₃ / Amberlyst 21, Et ₂ O, r.t.	18- 73	101
4	Ar/Et	 (-)- Sparteine	Yb(OTf) ₃ / Amberlyst 21, Et ₂ O or DCM, r.t.	15- 68	102

⁹⁸ M. Shimizu, Y. Ukaji, K. Inomata *Chem. Lett.* **1996**, 455-456.

⁹⁹ M. Tsuji, Y. Ukaji, K. Inomata *Chem. Lett.* **2002**, 1112.

¹⁰⁰ Y. Yoshida, Y. Ukaji, S. Fujinami, K. Inomata *Chem. Lett.* **1998**, 1023-1024.

¹⁰¹ H. Yamamoto, S. Hayashi, M. Kubo, M. Harada, M. Hasegawa, M. Noguchi, M. Sumimoto, K. Hori *Eur. J. Org. Chem.* **2007**, 2859-2864.

¹⁰² M. Gućma, W. M. Gołębiewski *J. Heterocyclic Chem.*, **45**, **2008**, 241-245.

Examples above lead to products with good to excellent enantiomeric excess, but these conditions are restricted to allylic alcohol (**2d**) and its derivatives.

4.1.3.1. Bis(Oxazoline) catalysts

C₂-symmetric bis(oxazoline) and salen-metal complexes have recently been shown to be very effective ligands for iron (III),¹⁰³ magnesium (II),¹⁰⁴ copper (II),¹⁰⁵ and chromium (III)¹⁰⁶ complex-catalyzed reactions. When a copper complex of **46** is used as a catalyst, the reaction can also proceed with excellent selectivity (98% de and >98% ee for the endo-isomer);¹⁰⁷ however, an opposite selectivity is achieved using Mg (II).

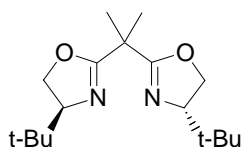


Figure 4-4. (4*S*,4'*S*)-2,2'-(propane-2,2-diyl)bis(4-tert-butyl-4,5-dihydrooxazole) (**46**).

The explanation for the topicity of the two complexes that lead to opposite stereo-outcomes is shown in Figure 4-5. Although they are

¹⁰³ Corey, E. J.; Imai, N.; Zhang, H. *J. Am. Chem. Soc.* **1991**, *113*, 728.

¹⁰⁴ Corey, E. J.; Ishihara, K. *Tetrahedron Lett.* **1992**, *33*, 6807.

¹⁰⁵ (a) Evans, D. A.; Miller, S. J.; Lectka, T. *J. Am. Chem. Soc.* **1993**, *115*, 6460. (b) Evans, D. A.; Lectka, T.; Miller, S. J. *Tetrahedron Lett.* **1993**, *34*, 7027. (c) Evans, D. A.; Murry, J. A.; von Matt, P.; Norcross, R. D.; Miller, S. J. *Angew. Chem. Int. Ed. Engl.* **1995**, *34*, 798. (d) Evans, D. A.; Johnson, J. S. *J. Org. Chem.* **1997**, *62*, 786.

¹⁰⁶ For the other studies of chiral bis(oxazolines) as enantioselective catalysts, see (a) Lowenthal, R. E.; Abiko, A.; Masamune, S. *Tetrahedron Lett.* **1990**, *31*, 6005. (b) Evans, D. A.; Woerpel, K. A.; Hinman, M. M.; Faul, M. M. *J. Am. Chem. Soc.* **1991**, *113*, 726. (c) Nishiyama, H.; Kondo, M.; Nakamura, T.; Itoh, K. *Organometallics* **1991**, *10*, 500. (d) Lowenthal, R. E.; Masamune, S. *Tetrahedron Lett.* **1991**, *32*, 7373.

¹⁰⁷ (a) Corey, E. J.; Imai, N.; Pikul, S. *Tetrahedron Lett.* **1991**, *32*, 7517. (b) Corey, E. J.; Sarshar, S.; Bordner, J. *J. Am. Chem. Soc.* **1992**, *114*, 7938.

similar C_2 -symmetric ligands, they are coordinated with metals in different tetravalent geometry, which leads to different reactions pathways. The tetrahedral magnesium complex facilitates cycloaddition to the C_2 Si-face because of rear phenyl blocking of the Re-face. In contrast, the square-planar copper complex favours Re-addition, due to its Si-face being blocked by a t-butyl group.

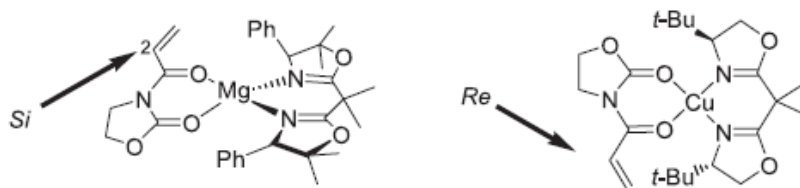
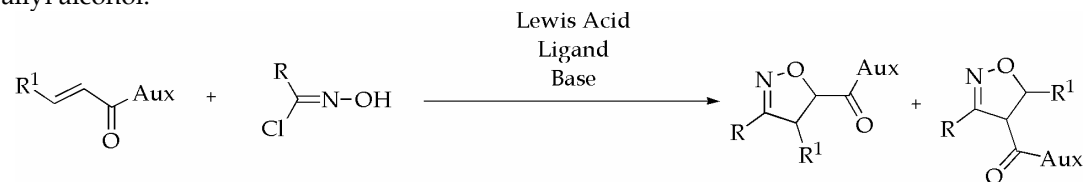


Figure 4-5.

Frequently chiral auxiliaries and metal complex are used together in 1,3-dipolar cycloaddition to improve the selectivity of the process; in Table 4-2 some examples are shown from the recent literature about the use of these conditions and the achieved enantiomeric excess.

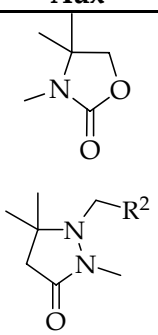
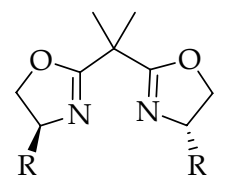
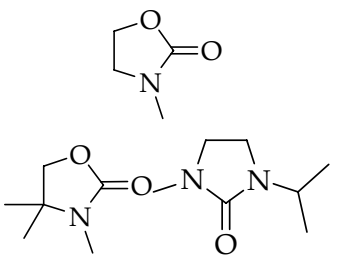
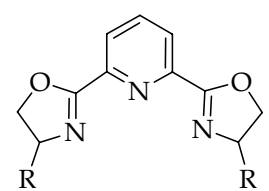
Table 4-2. Some examples from the recent literature about enantioselectivity in cycloaddition between hydroxamoyl chloride and allyl alcohol.

Entry	Aux	R/R ¹	Ligand	L.A./Conditions	ee %	Ref.
1		Ms/Me	-	Mg(ClO ₄) ₂ , Sc(OTf) ₂ or none/ NaBH ₄ , THF-H ₂ O, Δ	67- 72	108
2		Ar/H	-	ZnI ₂ , MgBr ₂ , Ni(ClO ₄) ₂ , Fe(ClO ₄) ₂ , Ti(OPr-i) ₄ or Cu(OTf) ₂ / Et ₃ N, DCM, 0 °C	46- 92	109, 110

R² = CH₂Ph, CH(CH₃)₂

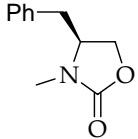
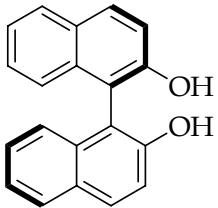
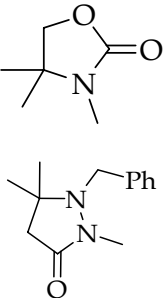
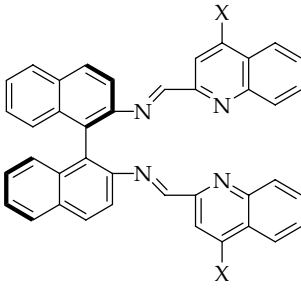
¹⁰⁸ G. Faita, A. Paio, P. Quadrelli, F. Rancati, P. Seneci *Tetrahedron Letters* 41 (2000) 1265-1269.

¹⁰⁹ H. Yamamoto, S. Watanabe, K. Kadotani, M. Hasegawa, M. Noguchi, S. Kanemasa *Tetrahedron Letters* 41 (2000) 3131-3136.

Entry	Aux	R/R ¹	Ligand	L.A./Conditions	ee %	Ref.
3		Ar, t-Bu/Me	 R = Me, <i>i</i> Pr, t-Bu, Ph	MgI ₂ , Mg(ClO ₄) ₂ , Mg(NTf ₂) ₂ , Ni(ClO ₄) ₂ , Ni(SbF ₆) ₂ or Cu(OTf) ₂ / MS 4 Å, DCM, r.t.	92-99	111
4		Ph/H	 R = Ph, CH ₂ Ph, <i>i</i> Pr	Yb(OTf) ₃ or MgBr ₂ / Et ₃ N, DCM, +35/-78 °C	38-87	101

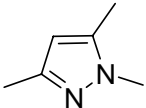
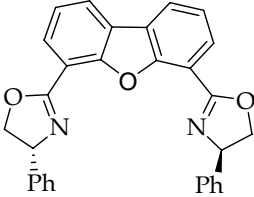
¹¹⁰ These are de % of the products with chiral auxiliaries.

¹¹¹ M. P. Sibi, K. Itoh, C. P. Jasperse *J. Am. Chem. Soc.* **2004**, *126*, 5366-5367.

Entry	Aux	R/R ¹	Ligand	Conditions	ee %	Ref.
5		Ar/Et	 R-(+)-Binol	Yb(OTf) ₃ / Amberlyst 21, Et ₂ O, r.t.	77	112
6		Ar, i-Bu/Me	 X = H, Me, Ph, 3,5-Xylyl	Ni(ClO ₄) ₂ · 6H ₂ O/ MS 4 Å, DCM, r.t.	70-92	113

¹¹² W. M. Gołębiewski, M. Gućma *J. Heterocyclic Chem.*, **45**, **2008**, 1687-1693.

¹¹³ H. Suga, Y. Adachi, K. Fujimoto, Y. Furihata, T. Tsuchida, A. Kakehi, T. Baba *J. Org. Chem.* **2009**, *74*, 1099-1113.

Entry	Aux	R/R ¹	Ligand	L.A./Conditions	ee %	Ref.
7		Ar, t-Bu/H		Ni(BF ₄) ₂ · 6H ₂ O/ MS 4 Å, DCM, 30-40 °C	90-97	114

¹¹⁴ F. Ono, Y. Ohta, M. Hasegawa, S. Kanemasa *Tetrahedron Letters* 50 (2009) 2111–2114.

4.2. Results and Discussion

In the reaction reported in Chapter 2 of this thesis,⁴ the base plays a key role in the mechanism because it is bound to the nitronate, which is the reagent involved in the cycloaddition. With a chiral base (disregarding the other possible regioisomers that in fact are not observed) as shown in Figure 4-6, the dipolarophile could approach two diastereomeric faces of the nitronate; if the two transition states have sufficiently different energy, it is possible to have an enantiomeric excess in the products. Therefore, in this process, the use of a chiral base could allow, in principle, the preparation of enantiomerically enriched cycloadducts.

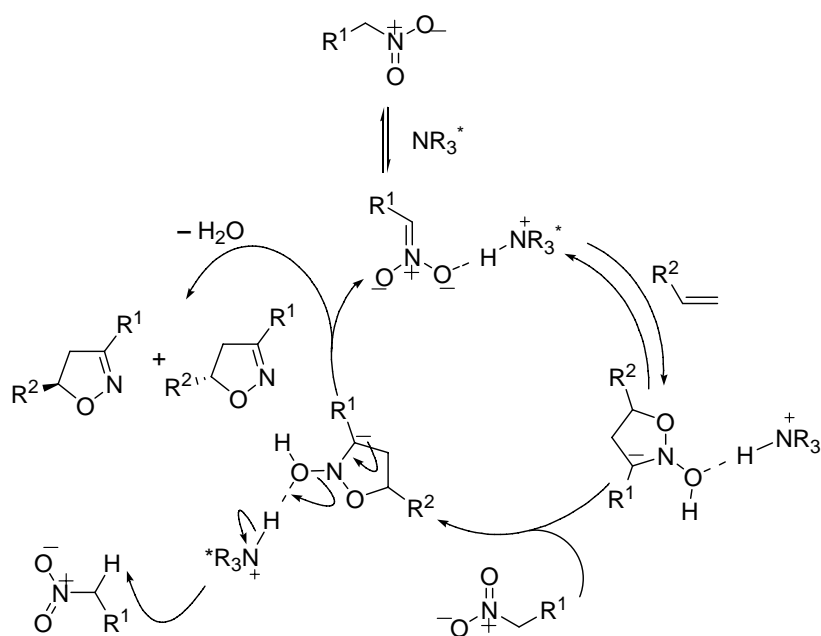
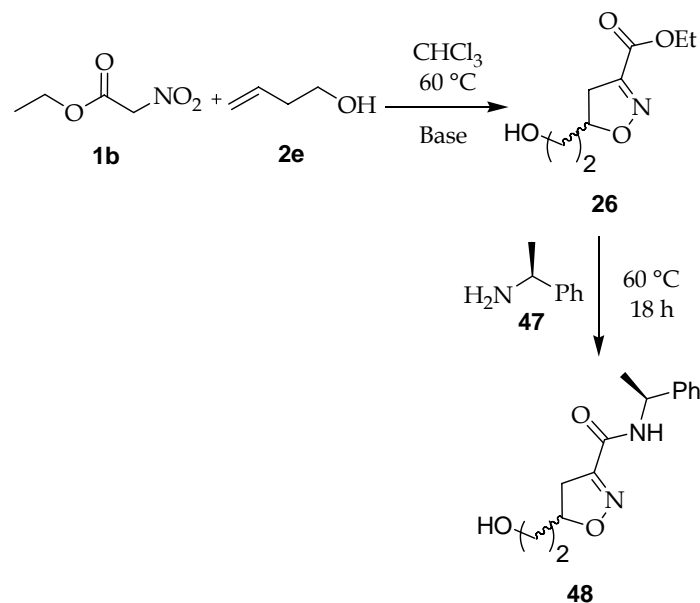


Figure 4-6.

The first problem is the choice of a convenient method suitable to check the eventual enantiomeric excess; three different methods have been tested: (1) a chemical transformation, (2) via $^1\text{H-NMR}$ with a shift reagent and (3) gas chromatographic analysis with a chiral column.

In the first case, it is possible to replace the ethoxy group by a chiral amine, to yield two diastereoisomers **48** (Scheme 4-3).



Scheme 4-3.

Unfortunately these diastereoisomers show no differences in the $^1\text{H-NMR}$, but it is possible to distinguish them by using Europium tris [3-(heptafluoropropylhydroxymethylene) - (+) - camphorate] as the shift reagent and, in some cases, gas-chromatography was employed. In this case, the column SIMPLICITY-5 was used and the suitable temperature program to analyse the two diastereoisomers **48** ratio (Figure 4-7) was chosen. The program used is illustrated in Table4-3, and as shown in

Figure 4-7, the peaks are well resolved and it is possible to evaluate the ratio (49.4: 50.6).

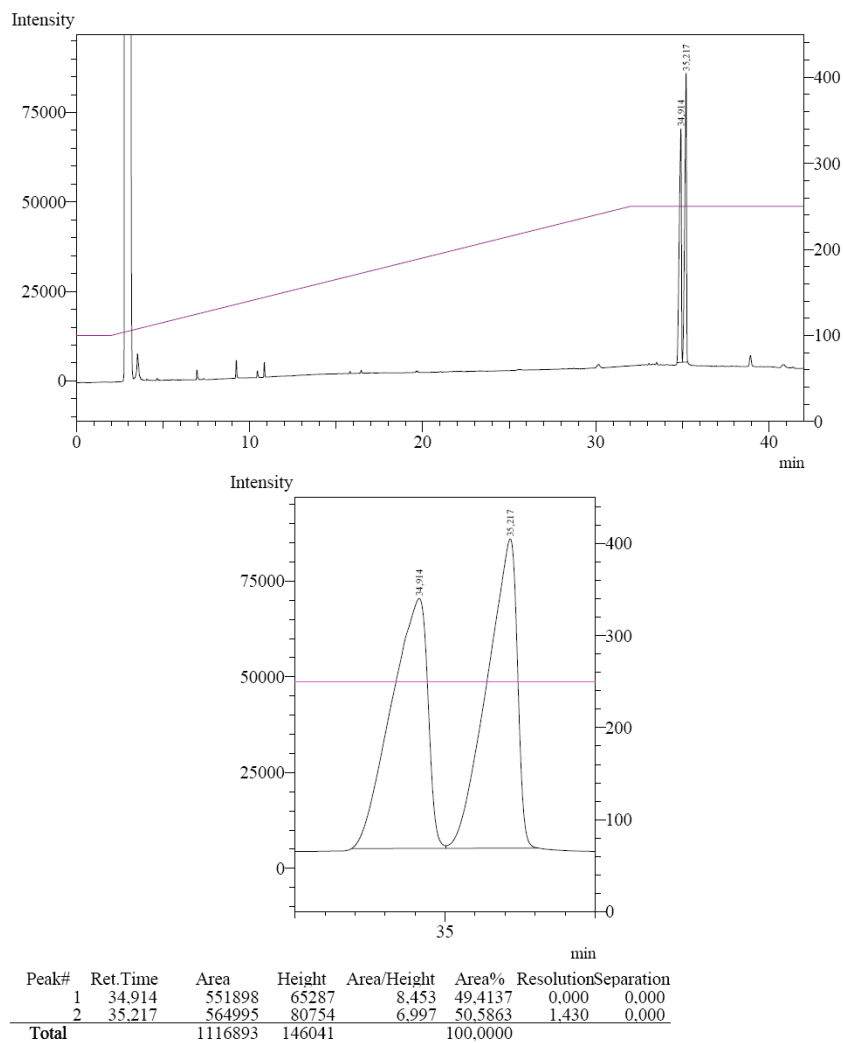


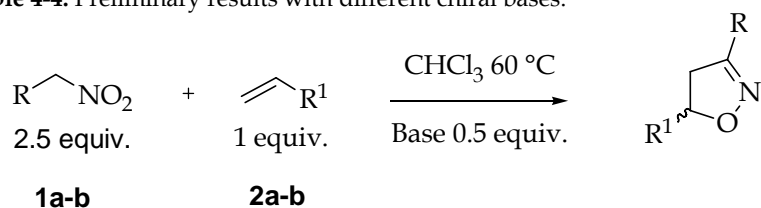
Figure 4-7. Gas-chromatogram of compound 48

Table 4-3. Program **Prog1** used for isoxazoline **48**

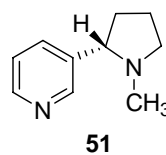
Rate (°C/min)	Temperature (°C)	Hold Time (min)
-	100	2
5	250	10

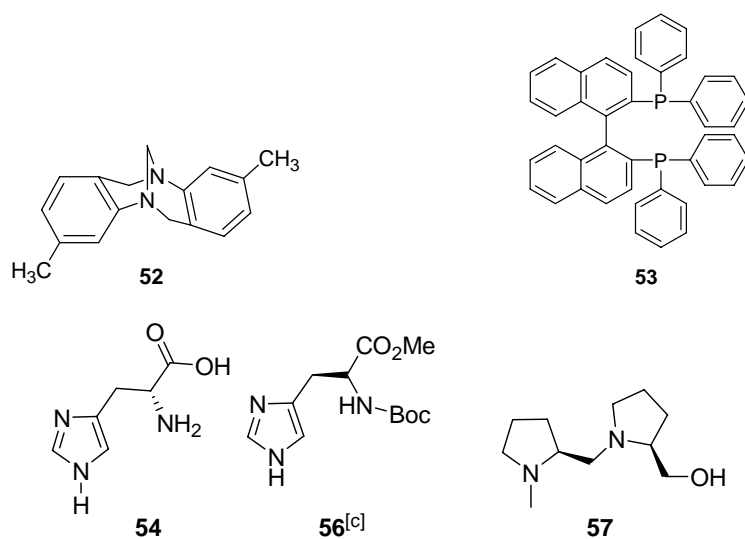
The derivation previously illustrated is possible only if the dipole is an ester or an amide and the shift reagent does not work with all substrates. In other cases the only way to check the enantiomeric excess is to use gas-chromatography with a proper chiral column (see experimental section of this chapter for details).


Some models of reactions were chosen in which different chiral tertiary diamines were employed in the usual conditions; the results are illustrated in Table 4-4.

Table 4-4. Preliminary results with different chiral bases.

Bases:





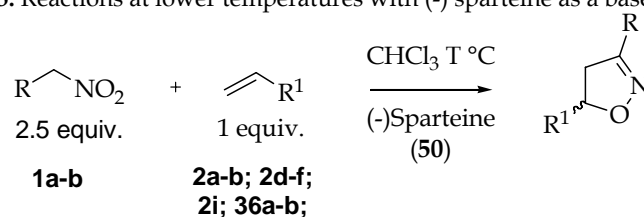
Entry	R	R ¹	Base	Time (h)	Conv. [a]	Prod.	Yield
1			50	96	94		97 ^[b]
2			52	40	0		-
3	CO ₂ Et		51	20	0	4	-
4			53	20	0		-
5			54	40	0		-
6			52	20	0		-
7			51	20	0		-
8	COPh	Ph	53	20	0	9	-
9			56	60	0		-
10			57	136	39		41 ^[b]

[a] Conversion evaluated by NMR; [b] After work-up; [c] Commercial compounds (54), but protected, as reported in Experimental section.


Conversion was observed only when (-) sparteine (50) and ((S)-1-(((S)-1-methylpyrrolidin-2-yl)methyl)pyrrolidin-2-yl)methanol (57) were employed as bases (entries 1 and 10). The reaction with (-) sparteine (50) was monitored with GC equipped with a chiral column, but no enantiomeric excess was observed. All reactions in Table 4-4 were carried out at 60 °C; when two diastereomeric transition states are

formed, they have a small difference of energy. At high temperature (as 60 °C), this difference is negligible but it might become important at lower temperature. Similar reactions with (-) sparteine (**50**) were carried out at lower temperatures to increase the selectivity and the results are illustrated in Table 4-5.

Table 4-5. Reactions at lower temperatures with (-) sparteine as a base.



Entry	R	R ¹	Base equiv.	T °C	t (h)	Conv. [a]	er %/ ee % [b]	Product
1			0.2	60	72	63	49.7 :50.3 0	
2			0.1	60	64	55	49.6 :50.4 0	
3			0.2	55	40	0	-	
4	CO ₂ Et	(CH ₂) ₂ OH	0.2	50	70	0	-	26
5			0.2	25	2 months	75	51:49 2	
6			0.2	25 ^[c]	72	0	-	
7			0.2	4	1 month	0	-	
8			0.2	60	40	57 ^[d]	49.2 :50.8 0	
9	CO ₂ Et	CH ₂ OH	0.1	60	96	100 ^[e]	47.9 :47.1 0	24
10			0.2	50	72	0	-	
11	CO ₂ Et	Ph	0.2	30	144	0	-	10
12	CO ₂ Et	OEt	0.2	30	144	0	-	58
13			0.1	60	24	100	49.8 :50.2 0	
14	COPh	Ph	0.1	50	24	100	50.5:49.5 0	9
15			0.1	40	40	67	49.4 :50.6 0	

Entry	R	R ¹	Base equiv.	T °C	t (h)	Conv. [a]	er %/ ee % [b]	Product
16			0.1	30	120	100	51.8:48.2 3.6	
17	COPh	Ph	0.5	30	120	74	48.8:51.2 2.4	9
18			0.1	25	240	53	48.6:51.4 2.8	
19	COPh	OEt	0.2	30	74	100	51:49 2	59
20			0.1	25	168	46	51:49 2	
21	COPh	CO ₂ Me	0.1	30	72	60	50.1:49.9 0	60
22			0.1	25	168	39	50:50 0	
23	COPh	CONMe ₂	0.1	25	168	35	- [f]	61
24	COPh		0.1	25	288	100	- [f]	4
25	COPh	(CH ₂) ₃ NO ₂	0.1	25	288	100	- [f]	28

[a] Conversion evaluated by NMR [b] enantiomeric excess is based on gas-chromatographic analysis; [c] in the presence of molecular sieve; [d] the crude contains less than 5% of the corresponding 4-substituted regioisomer; [e] the crude contains less than 5% of the corresponding 4-substituted regioisomer (**25**); the er for the regioisomer is 1.9:2.1; [f] the peaks were not resolved.

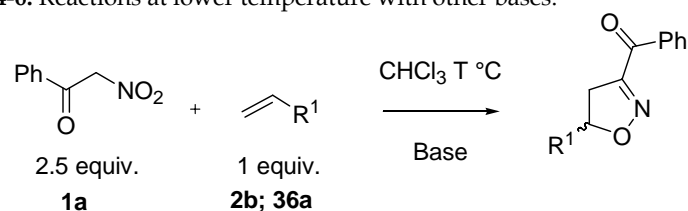
Some reactions at 60 °C (entries 1, 2, 8, 9 and 13), were carried out in order to check the capability of these substrates to give the products with (-) sparteine (**50**) as a base; this base appears suitable in general for almost all the substrates and many nitro compounds and dipolarophile were used. Different dipolarophiles including alcohols (**2d-e**) (entries 1-10) or ethers (**2i**) (entries 12, 19 and 20) were chosen since they are known to improve the selectivity in these reactions.^{87,96-102}

Among the reactions carried out at temperatures lower than 60 °C (from 55 to 4 °C), some did not react even after a long time (entry 7); the others required days to give conversion and, a low or negligible enantiomeric excess was found (only enantiomeric excesses with a value greater than 2% were considered). The reaction between 3-buten-1-ol (**2e**) and ethyl

nitroacetate (**1b**) (entry 5) was carried out at higher concentration of reagents (0.4 mL of CHCl_3 instead of 1.4 mL) and in absence of solvent: an increasing of reaction rate was noticed, but these conditions are possible only with these specific liquid reagents.

In Table 4-6 are shown reactions which were carried out by using a different base than (-) sparteine (**50**) and which have given a significant conversion at 60 °C. These reactions were carried out at lower temperatures and the results are illustrated in Table 4-6.

Table 4-6. Reactions at lower temperature with other bases.



Entry	R ¹	Base (equiv.)	T °C	t (h)	Conv. [a]	er %/ ee% ^[b]	Product
1		55 (0.1)	30	168	32	50.1:49.9 0	
2	Ph	55 (0.1)	25	240	44	49 :51 2	9
3		57 (0.1)	30	168	39	50.2:49.8 0	
4	CO ₂ Me	55 (0.1)	25	384	35	49.8:50.2 0	60

[a] Conversion evaluated by NMR [b] enantiomeric excess is based on gaschromatographic analysis.

The reaction time depends on the reagents used, the amount of base and the temperature. It is worth noting that benzoyl nitromethane (**1a**), whatever the dipole used, is more reactive than ethyl nitroacetate (**1b**); in fact, conversion in cycloadducts was observed at room temperature and in an acceptable time, but no enantiomeric excess was noted.

4.2.1. Reactions in presence of a catalytic amount of Copper (II) salts

In the reactions previously shown the rate is too low, or in the case of ethyl nitroacetate (**1b**), conversion was not observed. In order to increase the reaction rate, a catalytic amount of copper (II) salt was added. (-) Sparteine (**50**) is a perfect base to use with copper salts; in fact, this alkaloid with two nitrogen atoms in a specific spatial orientation (Figure 4-8), is an excellent ligand for metal complexes, useful as chiral chelating base in asymmetric synthesis.¹¹⁵

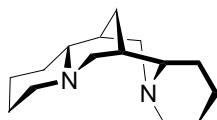


Figure 4-8. Structure of (-) sparteine (**50**).

Some model reactions were carried out in these conditions and the results are illustrated in Table 4-7.

Table 4-7. Reactions in the presence of a catalytic amount of Cu(AcO)₂.

Entry	R	R ¹	Cu ^{II} Equiv.	T °C	t (h)	Conv. [a]	er %/ ee% ^[b]	Prod.
1 ^[f]			-	30	144	0	-	
2 ^[f]	CO ₂ Et	Ph	0.05	30	144	24	48.9:51.0 2.1	10
3 ^[f]			-	30	144	0	-	
4 ^[f]	CO ₂ Et	OEt	0.05	30	144	38	- ^[e]	58

¹¹⁵ B. Jasiewicz et al, *J. Mol. Struct.*, **2006**, 794, 311-319.

Entry	R	R ¹	Cu ^{II} Equiv.	T °C	t (h)	Conv. [a]	er %/ ee% ^[b]	Prod.
5 ^[f]	CO ₂ Et	CONMe ₂	-	30	144	23 ^[c]	-	37b
6 ^[f]			0.05	30	144	32 ^[d]	47.8:52.2 4.4	38b
7 ^[f]			-	30	74	100	51:49 2	
8 ^[f]	COPh	OEt	0.05	30	74	100	50.6:49.4 0	59
9 ^[f]			-	0	240	0	-	
10 ^[f]			0.05	0	240	0	-	
11 ^[g]			-	30	88	100	-	
12 ^[g]	CONHMe	OEt	0.05	30	44	100	49.5:50.5 0	62
13 ^[g]			-	0	70	12	-	
14 ^[g]			0.05	0	70	15	50.7:49.3 0	
15 ^[g]	CONHMe	CONMe ₂	-	30	112	48	-	
16 ^[g]			0.05	30	112	82	50.6:49.4 0	63

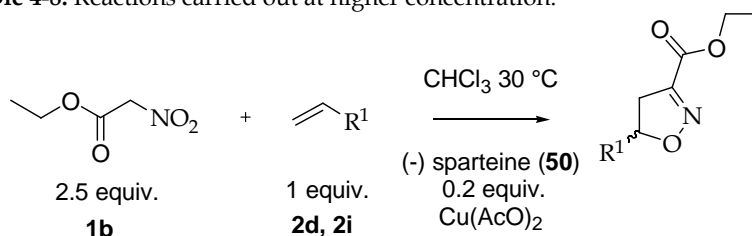
[a] Conversion evaluated by NMR [b] enantiomeric excess is based on gaschromatographic analysis; [c] the conversion is in the Michael adduct (see Chapter 3), the cycloadduct is not observed; [d] the conversion is in the cycloadduct, but the crude contains a considerable amount of the Michael adduct (see Chapter 3); [e] the peaks were not resolved; [f] The reactions were carried out with 0.2 equiv. of base; [g] The reactions were carried out with 0.1 equiv. of base.

In Table 4-7 in comparison, the same reactions in the absence or in the presence of copper are shown; when metal is present, the reactions are faster. Moreover, it is worth noting the different reactivity of N,N-dimethylacrylamide (**36b**) (entries 5 and 6) in the presence of copper: the addition of a copper salt to the catalytic system increases the proportion of cycloadduct (this behaviour of electron-deficient olefins is illustrated in Chapter 3). Benzoyl nitromethane (**1a**) is more reactive than ethyl nitroacetate (**1b**), either in the presence or in the absence of metal. At 0 °C, conversion is not observed because of the reagents insolubility (entries 9-10), whereas N-methyl nitroacetamide (**1g**) reacts even at 0 °C,

and by the presence of copper salt the reaction velocity increases only with dimethyl acrylamide (**36b**) as a dipolarophile (entries 15-16).

The reactions of ethyl vinyl ether (**2i**) and allyl alcohol (**2d**) with ethyl nitroacetate (**1b**) were carried out at higher concentration (with 0.7 and 0.4 mL of CHCl₃ instead of 1.4 mL respectively) and in absence of solvent: in this case the reaction rate was increased, but this is due only to the use of these liquid reagents. Furthermore, in the reaction between allyl alcohol (**2d**) and ethyl nitroacetate (**1b**), the transesterificated product was observed (Table 4-8).

Table 4-8. Reactions carried out at higher concentration.



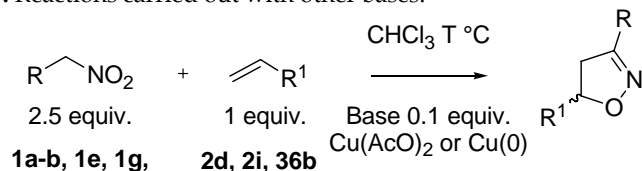
Entry	R ¹	Cu ^{II} equiv.	t (h)	Solv. mL	Conv. [a]	er %/ ee% ^[b]	Product
1		-	144	1.4	0	-	
2		0.05	144	1.4	31	-	
3	OEt	0.05	144	0.7	100	49.7 :50.3 0	58
4		0.05	144	0.4	100	-	
5		0.05	112	0	100	-	
6	CH ₂ OH	0.05	65	0.4	15 (11) ^[c]	-	24
7		0.05	65	0	7 (17) ^[c]	-	

[a] Conversion evaluated by NMR [b] enantiomeric excess is based on gas-chromatographic analysis; [c] the conversion in brackets refers to the transesterification product.

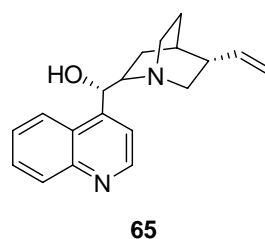
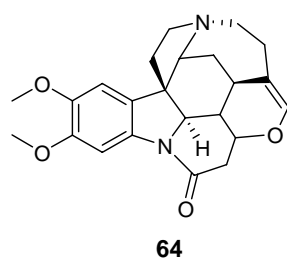
It has been shown that the reaction rate increases in the presence of copper salt, but no selectivity was observed; other chiral bases were chosen which could be excellent ligands for metal complexes. The

reactions with different bases were carried out at different temperatures and the results are illustrated in Table 4-9.

Table 4-9. Reactions carried out with other bases.



Bases:



Entry	R	R ¹	Base	T °C	[Cu] Equiv	t (h)	Conv. [a]	er %/ ee% ^[b]	P.
1			64	30	Cu(II) (0.05)	66	30	48.7:51.3 2.6	
2	COPh	OEt	51	30	Cu(II) (0.05)	144	31	50.4:49.6 0	59
3			65	60	Cu(0) (0.05)	22	100	50.3:49.7 0	
4	MeNHCO	Me ₂ NCO	64	30	Cu(II) (0.05)	64	43	- [d]	63
5	CO ₂ Et	CH ₂ OH	65	10	Cu(0) (0.05)	360	29	- [d]	24
6	CH ₃ (CH ₂) ₄ NO ₂	CH ₂ OH	64	60	Cu(0) (0.05)	64	44	52:48 4 ^[c]	66

[a] Conversion evaluated by NMR; [b] enantiomeric excess is based on gaschromatographic analysis; [c] The ee is an average of repeated analysis; [d] the peaks were not resolved.

The reaction between nitropentane (**1i**) and allyl alcohol (**2d**) (entry 6) was then carried out in different condition: (-) sparteine (**50**) was used as ligand for copper and NMP (**3c**) as base. After 42 hours the product was

found only in trace concentration; on gas-chromatographic analysis, an enantiomeric excess of 28% was found (Figure 4-9).

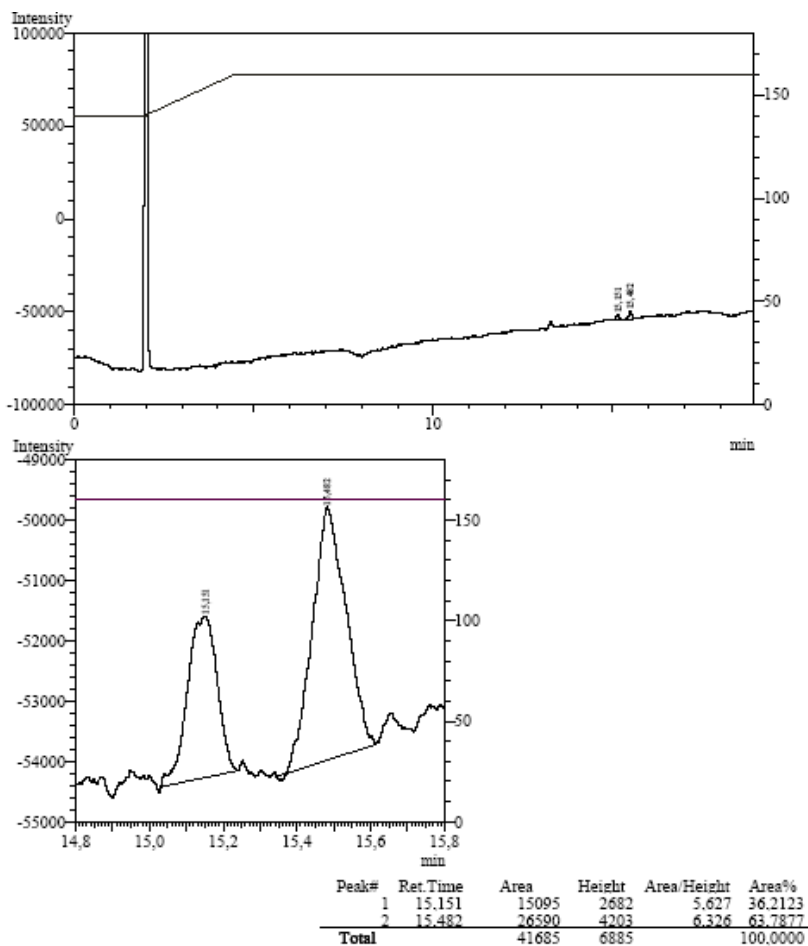


Figure 4-9. Gas-chromatogram of compound 66. Prog4 was used.

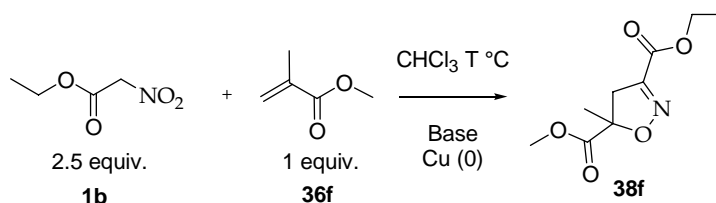
The analysis was repeated at different concentrations and no enantiomeric excess was found. There are two hypothesis for this result:

- 1) In the first analysis (Figure 4-9) the concentration was too low and the result was not reliable;

- 2) The cycloadduct racemises in the column and this process increases with the sample concentration.

In all these reactions enantiomeric excesses were low or absent; these results could be due to a wrong choice of the catalytic system or to the products instability; in fact the proton in the stereogenic center is acid and could cause racemisation. Therefore methyl methacrylate (**36f**) was chosen as dipolarophile, and reactions were carried out in presence of Cu(0), as well as different bases and temperatures (Table 4-10). With this dipolarophile no enantiomeric excess was observed.

Table 4-10. Reactions with methyl methacrylate (**36f**) as dipolarophile.



Entry	Base (equiv)	T °C	T (h)	Conv ^[a]	ee % ^[b]
1	DABCO (0.1)	60	66	100	0
2	(-) sparteine (0.2)	60	66	100	0
3	(-) sparteine (0.2)	30	144	66	0

[a] Conversion evaluated by NMR [b] enantiomeric excess is based on gas-chromatographic analysis.

4.2.2. Reactions with different ratio Dipole/Dipolarophile

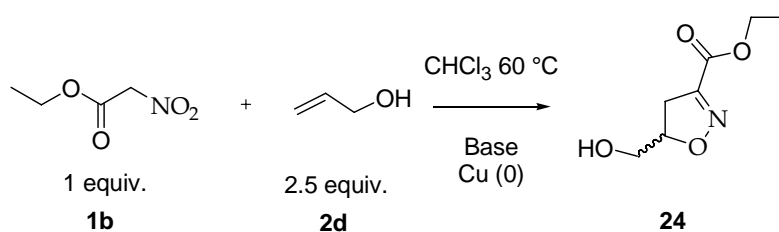
The complexation of Cu(II) with the mono-anion of nitroacetic ester has been described¹¹⁶ in analogy with the strong complex of Cu(II) reported for the dianion of nitroacetic acid.¹¹⁷ If the nitro compound is the reagent

¹¹⁶ A. Corsico Coda, G. Desimoni, A. Gamba, G. Invernizzi, P. P. Righetti, P. F. Seneci, G. Tacconi, *Gazz. Chim. Ital.* 1985, 115, 111 – 118.

¹¹⁷ K. Von Deuten, W. Hinrichs, and G. Klar, *Polyedron* 1982, 1, 247 – 251.

in excess and all Cu(II) is coordinated to it, how could the metal bind a dipolarophile and chiral base as well? As reported above, Cu(II) give a good coordination to allyl alcohol (**2d**), verified by NMR spectrum in absence of nitro compound; copper is a paramagnetic metal affecting the NMR spectra, leading to broad or undetectable signals and increased relaxation rates.¹¹⁸ In fact, when a catalytic quantity of copper is added, the allyl alcohol (**2d**) signals disappear in NMR spectra. To favour this coordination, the reactions were carried out with an inverted dipole/dipolarophile ratio with respect to the usual reaction conditions and the results are illustrated in Table 4-11.

Table 4-11. Reactions with an opposite ratio dipole/dipolarophile.



Entry	Base (equiv)	Cu (0) Equiv.	t (h)	Conv. [a]	er % [b]	ee % [b]
1	DABCO (0.1)	0.05	72	59	48.1:51.9	3.8
2	(-) sparteine (0.1)	0.05	72	57	50.0:50.0	0
3	(-) cinchonidin (0.1)	0.05	96	81	47.1:52.9	5.8

[a] Conversion evaluated by NMR [b] enantiomeric excess is based on gas-chromatographic analysis.

¹¹⁸ R. J. Smernik, J. M. Oades J. Environ. Qual. Vol. 31, March-April 2002, 414-420.

Reactions illustrated in Table 4-11 were all carried out at 60 °C; by using different ratio of reagents the reaction velocity was slower than usual, but a low enantiomeric excess with (-) cinchonidine (**65**) as base was observed (entry 3). An enantiomeric excess in entry 1 was observed as well, but this result was a false positive, because no chiral base was used.

4.2.3. Reactions in the presence of a chiral ligand

As shown in literature,^{96, 97} it is possible to use chiral ligands with the catalytic metal, to induce selectivity. Diethyl L-tartrate (**67**), a strong ligand for copper, and two different bisoxazolines (**68** and **69**) were chosen; the structures are shown in Figure 4-10.

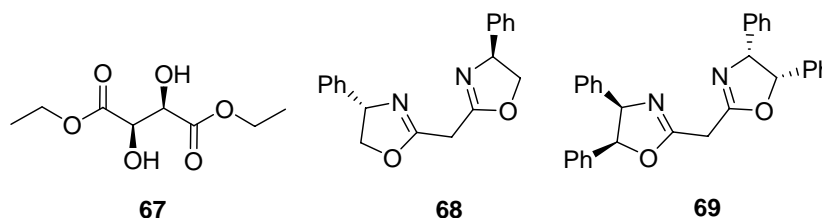
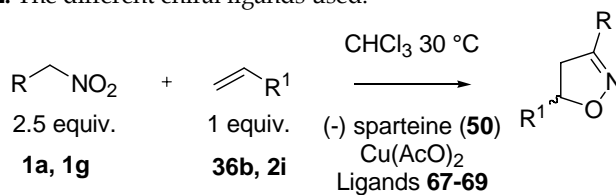


Figure 4-10. The ligands used.

These ligands with (-) sparteine (**50**) as base were used and results are illustrated in Table 4-12.

Table 4-12. The different chiral ligands used.

Entry	R	R ¹	Ligand (equiv)	t (h)	Conv ^[a]	er %/ ee % ^[b]	Product
1	PhCO	OEt	67 (0.05)	96	100	51.0:48.9 2.1	59
2 ^[c]			67 (0.05)	65	0	-	



Entry	R	R ¹	Ligand (equiv)	t (h)	Conv ^[a]	er %/ ee % ^[b]	Product
3			67 (0.3)	65	100	48.8:51.2 2.4	
4 ^[d]	PhCO	OEt	68 (0.05)	65	44	48.7:51.3 2.6	59
5			68 (0.05)	65	74	48.8:51.2 2.4	
6			69 (0.05)	65	23	- ^[e]	
10	MeNHCO	Me ₂ NCO	68 (0.05)	64	76	50.2:49.8 0	63
11			69 (0.05)	64	73	- ^[e]	

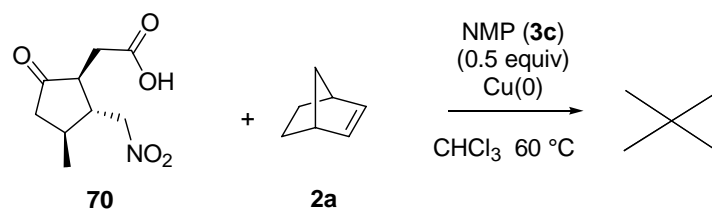
[a] Conversion evaluated by NMR [b] enantiomeric excess is based on gas-chromatographic analysis; [c] the reaction was carried out in absence of base; [d] reagents were added in different order: ligand and metal were stirred for 2 h to preform the complex; then were added the other reagents (see experimental section for details); [e] the peaks were not resolved.

The ligand **67** was added in two different proportions: stoichiometric (entry 1) or in excess of copper (entry 3); in the second case the minor quantity of the ligand to dissolve the metal at room temperature was used. These two different conditions have brought only a variation of the reaction velocity. The addition order was significant as well; in fact with different addition sequences, different reaction rates resulted in the same conditions (entries 4 and 5).

4.3. Diastereoselectivity

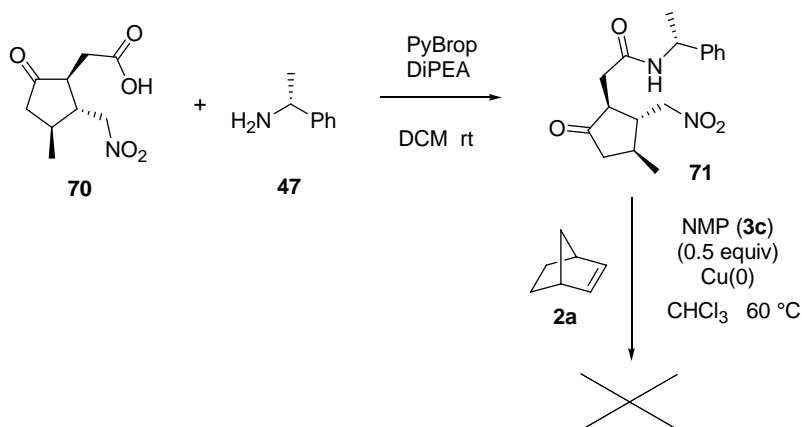
4.3.1. The use of a chiral nitro compound

As shown at the beginning of this chapter, different chiral auxiliaries have been explored, to induce cycloaddition selectivity. On the other hand selectivity could be induced by chirality on the nitro compound. A commercial nitro compound was chosen, but this product was unreactive, because of its acidity (Scheme 4-4).



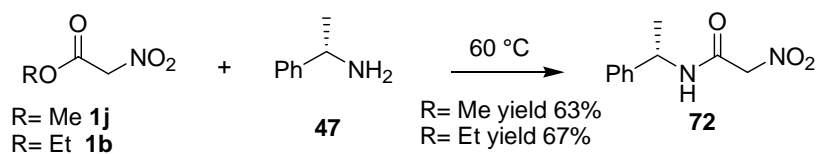
Scheme 4-4.

The acid **70** was then protected with an amidic bond with the chiral amine **47** and a mixture of two diastereoisomers (**71**) was obtained. A fraction of one pure diastereoisomer was treated with norbornene, but no product was observed (Scheme 4-5).



Scheme 4-5.

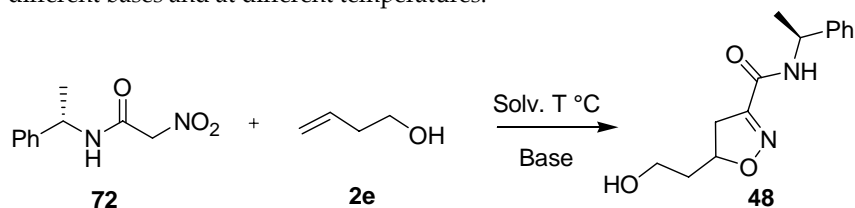
(*S*)-2-nitro-*N*-(1-phenylethyl)acetamide (**72**) is another chiral nitro compound used. The nitroacetamide **72** was obtained from methyl (**1j**) or ethyl nitroacetate (**1b**) and (*S*)-1-phenylethylamine (**47**) in good yield.



Scheme 4-6.

This compound reacted with 3-buten-1-ol (**2e**) in different conditions: temperature, base and solvent were varied and the results are reported in Table 4-13.

Table 4-13. Reaction between the nitroamide **72** and 3-buten-1-ol (**2e**) with different bases and at different temperatures.



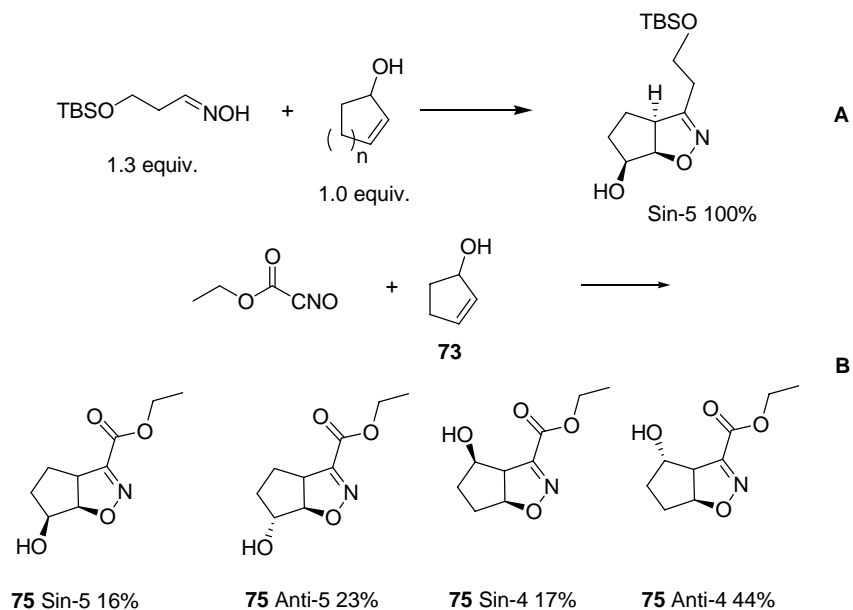
Entry	Base (equiv)	T °C	t (h)	Solvent	Conv. ^[a]	de % ^[b]
1	DABCO (0.1)	60	16	CHCl ₃	100	0
2	(-) sparteine (0.1)	60	16	CHCl ₃	70	0
3	DABCO (0.1)	25	144	CHCl ₃	52	- ^[d]
4	(-) sparteine (0.1)	25	144	CHCl ₃	51	- ^[d]
5	DABCO (0.1)	25	96	AcOEt ^[c]	0	-
6	(-) sparteine (0.1)	25	96	AcOEt ^[c]	0	-
7	(-) sparteine (0.5)	25	72	DMSO	0	-
8	DABCO (0.5)	25	40	EtOH:H ₂ O=2:1 ^[c]	0	-

[a] Conversion evaluated by NMR [b] diastereomeric excess is based on gas-chromatographic analysis; [c] reagents are insoluble in these solvents and the reactions were carried out as suspension; [d] the products were not analysed.

As noticed with other nitro compounds, no diastereomeric excess was observed even when the product was obtained at lower temperature than 60 °C. Reagents are insoluble in other solvents and no product was obtained.

4.3.2. The use of a racemic dipolarophile

Cyclopent-2-enol (**73**) is a dipolarophile used to obtain total diastereoselectivity in 1,3-dipolar cycloaddition. The cycloaddition was carried out with nitrile oxides, and depending on the dipole used different diastereoselectivities have been reported (Scheme 4-7).



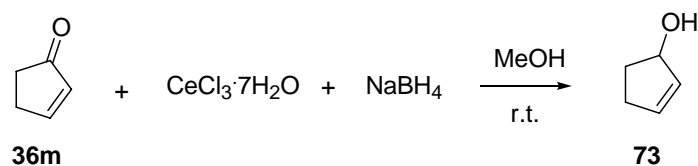
Scheme 4-7. Diastereoselective synthesis with alcohol **73** as dipolarophile.^{119,120}

The corresponding ketone **36m** was reduced using rare earth halides and sodium borohydride for the selective conversion of α,β unsaturated ketones to allylic alcohols **73** (Scheme 4-8).¹²¹

¹¹⁹ N. Becker, E. M. Carreira *Org. Lett.*, Vol. 9, No. 19, **2007**, 3857-3858.

¹²⁰ P. Conti, M. De Amici, A. Pinto, L. Tamborini, G. Grazioso, B. Frølund, B. Nielsen, C. Thomsen, B. Ebert, C. De Micheli *Eur. J. Org. Chem.* **2006**, 5533-5542. The assignment was done comparing the diastereoisomers characterised in this literature.

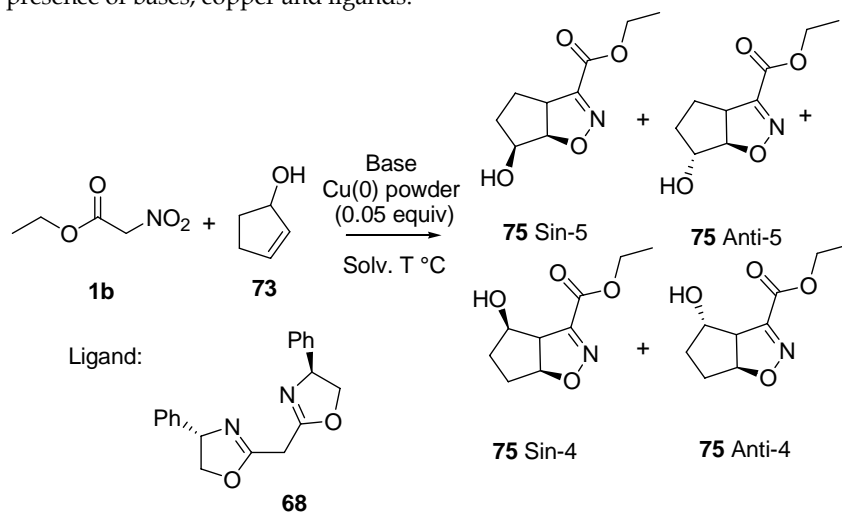
¹²¹ R. Marshall Wilson, Fiona Geiser *J. Am. Chem. Soc.*, **1978**, 226-227.



Scheme 4-8.

The cycloaddition was then carried out with the alcohol **73** and ethyl nitroacetate (**1b**) in different conditions; the possible products are four diastereoisomers **75** and their ratio was determined by GCMS (Table 4-14).

Table 4-14. Reaction between ethyl nitroacetate (**1b**) and the alcohol **73** in presence of bases, copper and ligands.

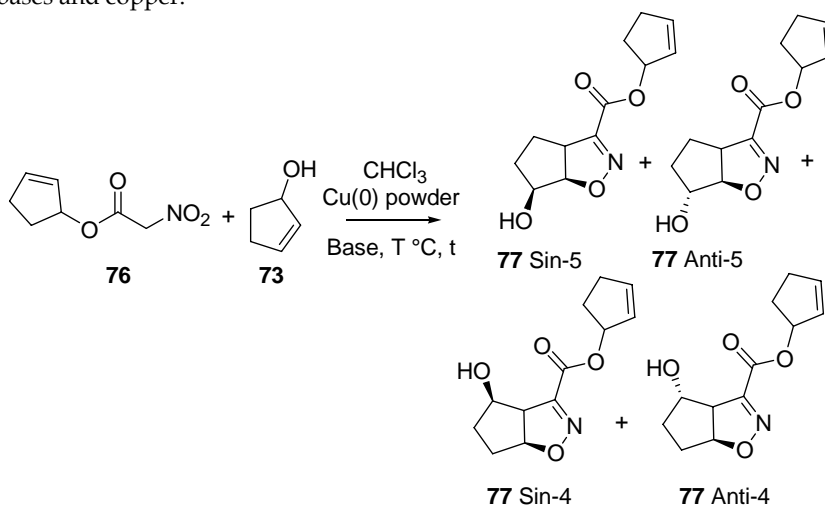


Entry	Base (equiv)	Ligand (equiv)	T °C	t (h)	Conv. [a]	Sin-5 % [b]	Anti-5 % [b]	Sin-4 % [b]	Anti-4 % [b]
1			80	16	100	36	13	17	34
2			60	17	100	46	5	21	28
3	NMP (0.2)	-	30	88	~100	49	11	27	13
4			30	88	trace ^[c]	-	-	-	-
5			10	264	trace (50) ^[d]	52	10	13	27

Entry	Base (equiv)	Ligand (equiv)	T °C	t (h)	Conv. [a]	Sin-5 % ^[b]	Anti-5 % ^[b]	Sin-4 % ^[b]	Anti-4 % ^[b]
6	DABCO (0.1)	-	60	24	100	45	2	18	35
7		-	30	168	~50	48	10	13	29
8		68 (0.1)	60	72	100	39	6	18	37
9	TMPDA (0.1)	-	60	24	100	42	10	18	30
10		-	30	72	82	46	10	14	30
11	(-)	-	60	72	100	43	10	17	30
12	cinconidin (0.1)	-	30	264	74	44	9	15	28
13		68 (0.1)	60	72	100	39	2	22	37
14	(-) sparteine (0.2)	-	60	66	100	49	8	16	27
15		-	30	264	58	50	8	14	28
16		10	336	trace (35) ^[e]	- ^[f]	-	-	-	

[a] Conversion evaluated by NMR [b] diastereomers ratio is based on gas-chromatographic analysis; [c] Cu(AcO)₂ was used; [d] the conversion in parentheses is after 18 days; [e] the conversion in parentheses is after 37 days; [f] The products were not analysed.

As shown in Table 4-14., the diastereoisomeric ratio is maintained regardless of the base, temperature and ligand used. A higher selectivity can be obtained by using a more hindered dipole; in the reaction illustrated in Table 4-14., the transesterificated nitro ester **76** was obtained besides the cycloadducts; this product reacted with the dipolarophile as well and the products (**77**) were analyzed by GCMS; results are illustrated in Table 4-15.

Table 4-15. Reaction between the nitroester **76** and the alcohol **73** in presence of bases and copper.

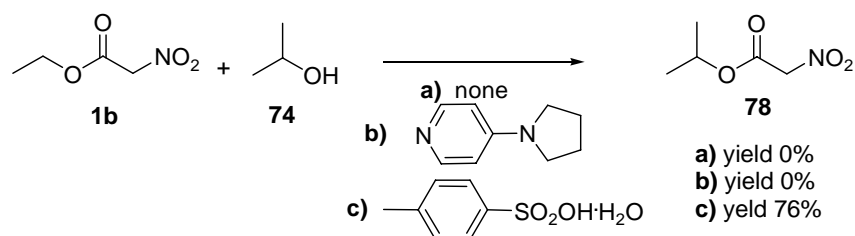
Entry	Base (equiv)	T °C	t (h)	Conv. [a]	Sin-5 % [b]	Anti-5 % [b]	Sin-4 % [b]	Anti-4 % [b]
1	NMP (0.2)	10	264	trace	63	7	30	0
2	(-) cinchonidin (0.1)	30	264	74	51	6	21	22
3	(-) sparteine (0.2)	30	264	58	65	8	27	0
4		10	336	trace	70	4	26	0

[a] Conversion evaluated by NMR [b] diastereomers ratio is based on gas-chromatographic analysis.

By using the nitro compound **76**, obtained *in situ*, the selectivity was increased; the selectivity depends only on the base, but not on the temperature (see entries 3-4 in Table 4-15). In this case the selectivity obtained is different from published results,¹²⁰ which use the same substrates.

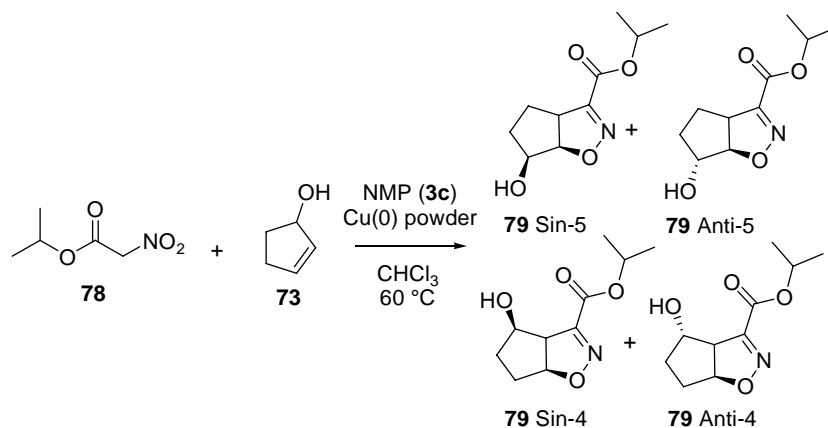
Another hindered ester was then prepared from the reaction of ethyl nitroacetate (**1b**) and isopropyl alcohol (**74**): the transesterification

reaction was carried out in neutral (a), basic (b) and acid (c) conditions (Scheme 4-9), but product **78** was obtained only in acid condition.



Scheme 4-9.

The nitroester **78** was then reacted with the alcohol **73** and the product ratio was determined with GCMS (Scheme 4-10).



Scheme 4-10.

Conversion was 100% after 19 hours, but the presence of all the diastereoisomers were revealed in similar ratio of the cycloadducts **75** (in the same conditions).

4.4. Conclusions

In this Chapter a preliminary screening of different chiral bases and ligands was reported, in order to evolve the reaction of condensation-cycloaddition in the direction of an enantioselective approach. With the used chiral systems, only low enantiomeric excess was obtained.

The next step will be the use of more suitable ligands for the metal, for example bisoxazolines as **46** (Figure 4-4), and the use of different solvent such as water, as illustrated in Chapter 6 (Paragraph 6.2.3).

4.5. Experimental section

General methods: for the instruments used and other details see Experimental Section in Chapter 2. All compounds were named with Autonom® (Beilstein Information Systems) and modified where appropriate. EI (electron impact) mass spectra were obtained using a Shimadzu QP5050A quadrupole based mass spectrometer (direct introduction unless otherwise stated, at ionising voltage of 70 eV); GC spectra were obtained using a Shimadzu GC-2010 with two different columns: the column used to check the diastereoisomers is SIMPLICITY-5, with film thickness of 0,25 µm, length 30,0 m and with inner diameter of 0,25 mm; the column used to check the enantiomers is Beta DEX™ 120, with film thickness of 0,25 µm, length 30,0 m and with inner diameter of 0,25 mm; the programs used were illustrated in Table 4-16.

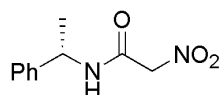
Materials: Products **26** and **24** have been already characterised in Chapter 2 and products **38b** and **38f** in Chapter 3. DABCO (**3**), NMP (**3c**), (-) sparteine (**50**), (R)-tert-butyl 4-(2-(tert-butoxycarbonylamino)-3-methoxy-3-oxopropyl)-1H-imidazole-1-carboxylate (**55**), ((S)-1-(((S)-1-methylpyrrolidin-2-yl)methyl)pyrrolidin-2-yl)methanol (**57**), Brucine (**64**), (S)-(-)-nicotine (**51**), (-) cinchonidine (**65**) and TMPDA (**3f**) were used as bases; (2R,3R)-diethyl 2,3-dihydroxysuccinate (**67**), bis((S)-4-phenyl-4,5-dihydrooxazol-2-yl)methane (**68**)

and bis((4R,5S)-4,5-diphenyl-4,5-dihydrooxazol-2-yl)methane (**69**) were used as ligands. Conditions were illustrated in Tables 4-5/4-17.

Table 4-16. Programs used for GC analysis.

Programs	Column	Rate (°C/min)	Temperature (°C)	Hold Time (min)
Prog1	Simplicity-5	-	100	2.00
		5	250	10.00
Prog2	Simplicity-5	-	100	2.00
		5	200	40.00
Prog3	Simplicity-5	-	80	2.00
		10	170	20.00
		10	280	5.00
Prog4	Beta DEX™ 120	-	140	165.0
		8	160	130.0
Prog5	Beta DEX™ 120	-	140	2.00
		8	160	130.0
Prog6	Beta DEX™ 120	-	160	5.00
		8	220	160.0
Prog7	Beta DEX™ 120	-	140	40.00
		8	160	100.0
Prog8	Beta DEX™ 120	-	160	240.0
		8	200	160.0

Preparation of *N*-Phenylethyl-2-nitroacetamide (**72**)¹²²

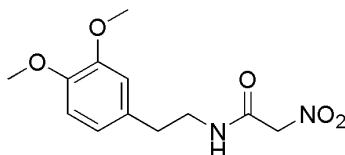


A) Phenylethyl amine (**47**) (2.42 mL, 5 equiv) was added drop to drop to ethyl nitroacetate (**1b**) (0.50 g, 3.76 mmol) in ice bath, then was heated under stirring at 60 °C. After 44 h the mixture was cooled and 5% HCl added down to pH = 3, and the product was filtered, afforded the amide **72** as white solid. Yield 0.524 g, 67%.

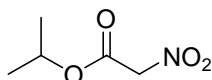
¹²² Sular G. Manjunatha, K. Venodhar Reddy, Srinivasachari Rajappa, *Tet. Lett.*, **1990**, 31 (9), 1327-1330.

B) Phenylethyl amine (**47**) (1.08 mL, 5 equiv) was added drop to drop to methyl nitroacetate (**1j**) (0.20 g, 1.68 mmol) in ice bath, then was stirred at room temperature. After 22 h, 5% HCl was added to the mixture down to pH = 3, and the product was filtered, yielding the amide **72**. White Solid, 221 mg, 63%. ^1H NMR: δ = 1.55 (dd, J = 7.0 and 2.6 Hz, 3 H, CH_3), 5.06 (s, 2 H, CH_2NO_2), 5.14 (m, 1H, CHMe), 6.67 (m, 1 H, NH), 7.27 - 7.36 (m, 5 H, Ph-H) ppm. MS (EI): m/z (%) = 193 (7) [$\text{M} - \text{Me}$] $^+$, 162 (100) [$\text{M} - \text{NO}_2$] $^+$, 147 (24), 132 (39) [PhCH_2NCO] $^+$, 119 (65), 105 (84), 91 (45) [PhCH_2] $^+$, 77 (73). IR (CDCl_3) = 3413 (NH), 2973, 1689 ($\text{C}=\text{O}$), 1561, 1522, 1450, 1376 cm^{-1} .

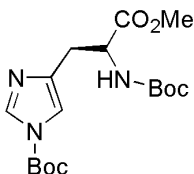
Preparation of *N*-(3,4-dimethoxyphenethyl)-2-nitroacetamide (**80**)



3,4-dimethoxyphenethyl amine (5.67 mL, 10 equiv) was added drop to drop to methyl nitroacetate (**1j**) (0.400 g, 3.36 mmol) in ice bath, then was stirred at room temperature. After 16 h, 5% HCl was added to the mixture down to pH = 3, and extracted with ethyl acetate. The organic phase was concentrated and the residue purified by chromatography on silica gel eluting with ethyl acetate/petroleum ether 3:2 (R_f = 0.37), and then recrystallized from ethyl ether, yielding the amide **80**. Yellowish solid, 437 mg, 49%. ^1H NMR: δ = 2.80 (t, J = 6.77 Hz, 2 H, CH_2Ar), 3.57 (q, J = 6.77 Hz, 2 H, CH_2NHCO), 3.85 (s, 3H, OMe), 3.87 (s, 3H, OMe), 5.04 (s, 2H, CH_2NO_2), 6.53 (br s, 1 H, NH), 6.70 (m, 2 H, Ar-H), 6.81 (m, 2 H, Ar-H) ppm. ^{13}C NMR: δ = 34.8 (t, 1C, CH_2Ar), 41.3 (t, 1C, CH_2NH), 55.9 (q, 2C, OMe), 77.8 (t, 1C, CH_2NO_2), 111.5 (d, 1 C, Ar-C), 120.6 (d, 1C, Ar-C), 130.5 (s, 1 C, Ar-C), 147.9 (s, 1C, Ar-C), 149.2 (s, 1C, Ar-C), 159.9 (s, 1C, $\text{C}=\text{O}$) ppm. MS (EI): m/z (%) = 268 (19) [M] $^+$, 164 (100) [$\text{M} - \text{NH}_2\text{COCH}_2\text{NO}_2$] $^+$, 151 (93) [$\text{M} - \text{CH}_2\text{NHCOCCH}_2\text{NO}_2$] $^+$, 107 (11), 91 (7) [PhCH_2] $^+$, 77 (9).

Preparation of Nitro-acetic acid isopropyl ester (78)

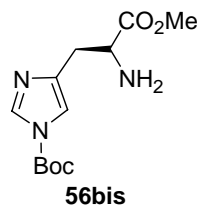
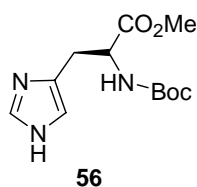
To a mixture of methyl nitroacetate (**1j**) (390 μ L, 4.25 mmol) and isopropyl alcohol (**74**) (1.62 mL, 21.2 mmol) was added toluene-4-sulfonic acid (80.8 mg, 0.425 mmol). After 96 h the excess of alcohol was removed in vacuo and the crude was purified by chromatography on silica gel eluting with ethyl acetate/petroleum ether 1:5 (R_f =0.46). Clear oil, 163 mg, 34%. $^1\text{H NMR}$: δ = 1.32 (d, J = 4 Hz, 6 H, $(\text{CH}_3)_2\text{CH}$), 5.17 (s, 2 H, CH_2NO_2), 5.21 (m, 1H, CH) ppm.

Preparation of (R)-tert-butyl 4-(2-(tert-butoxycarbonylamino)-3-methoxy-3-oxopropyl)-1H-imidazole-1-carboxylate (55**)¹²³**

To a suspension of L-Histidine methylester dichlorohydrate (500 mg, 2.07 mmol) in CH_3CN (5mL), were added DiPEA (1.14 mL, 6.62 mmol, 3.2 equiv.) and Boc_2O (497 mg, 2.28 mmol, 1.1 equiv). The mixture was stirred at room temperature for 12 h. The solvent was removed in vacuo and the crude was dissolved in dichloromethane (10 mL). The organic phase was washed with H_2O (2x5 mL), dried with Na_2SO_4 , filtered and concentrated in vacuo. The product was purified by chromatography, yield **55** (609 mg, 80%). Eluant: petroleum ether/ethyl acetate 2:1, R_f = 0.25. White solid. $^1\text{H NMR}$: δ = 1.43 (s, 9 H, tBu), 1.60 (s, 9 H, tBu), 3.04 (d, J = 6.2 Hz, 2 H, CH_2), 3.72 (s, 3 H, OMe), 4.58 (m, 1 H, $\text{CH}_\alpha\text{NH}$), 5.69 (m, 1 H, NH), 7.13 (s, 1 H, Het-H), 7.97 (s, 1 H, Het-H) ppm.

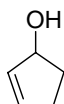
¹²³ D. K. Mohapatra, K. A. Durugkar *ARKIVOC*, **2005**, xiv, 20-28.

Preparation of (R)-methyl 2-(tert-butoxycarbonylamino)-3-(1H-imidazol-4-yl)propanoate (56) and 4-(2-Amino-2-methoxycarbonyl-ethyl)-imidazole-1-carboxylic acid tert-butyl ester (56bis)^{124, 125}



To a suspension of L-Histidine methylester dichlorohydrate (1.00 g, 4.14 mmol) in CH₃CN (5mL), were added DiPEA (**3d**) (1.56 mL, 9.11 mmol, 2.2 equiv.) and Boc₂O (904 mg, 4.14 mmol, 1 equiv). The mixture was stirred at room temperature for 2 h. The solvent was removed in vacuo and the crude was dissolved in dichloromethane (10 mL). The organic phase was washed with H₂O (2x5 mL), dried with Na₂SO₄, filtered and concentrated in vacuo. The product was purified by chromatography, yield **56bis** (132 mg, 9%) and **56** (276 mg, 25%). Eluant: dichloromethane/methanol 20:1, R_f = 0.32. White solid. **56bis**: ¹H NMR: δ = 1.56 (s, 9 H, tBu), 2.79 (dd, J = 14.5 and 7.7 Hz, 1 H, CH₂), 2.98 (dd, J = 14.5 and 4.7 Hz, 1 H, CH₂), 3.69 (s, 3 H, OMe), 3.80 (dd, J = 7.7 and 4.7 Hz, 1 H, CH_aNH), 7.14 (s, 1 H, Het-H), 7.95 (s, 1 H, Het-H) ppm. **56**: ¹H NMR: δ = 1.41 (s, 9 H, tBu), 3.09 (d, J = 5.3 Hz, 2 H, CH₂), 3.68 (s, 3 H, OMe), 4.54 (m, 1 H, CH_aNH), 5.84 (m, 1 H, NH), 6.79 (s, 1 H, Het-H), 7.53 (s, 1 H, Het-H) ppm.

Preparation of Cyclopent-2-enol (73)¹²⁶



To a solution of CeCl₃·7H₂O (1.86 g, 5 mmol) in 12.5 mL of MeOH, were added 419 mL (5 mmol) of cyclopenten-2-enone (**36m**). To the slightly yellow solution

¹²⁴ A. M. Kimbonguila, S. Boucida, F. Guibé, A. Loffet *Tetrahedron*, **1997**, 53, 12525-12538.

¹²⁵ B. O. Handford, T. A. Hylton, K. T. Wang, B. Weinstein, *J. Org. Chem.*, **1968**, 33, 4251-4255.

¹²⁶ N. Becker, E. M. Carreira *Org. Lett.* **2007**, 9, 3857-3858.

was added 189 mg (5 mmol) of NaBH₄ in portions over 2 min at 0 °C. The mixture started foaming upon addition, turned cloudy, became warm and clear again upon stirring more. After the addition was complete, a turbid solution was obtained. It was stirred for 4 min, then quenched by addition of water and extracted with 3 x 30 mL of diethyl ether. The solvent was removed in vacuo maintaining the temperature below 50 °C. Clear oil, 368 mg, 88%. ¹H NMR: δ = 1.52 (br s, 1H), 1.75-1.64 (m, 1H), 2.33-2.19 (m, 2H), 2.58-2.44 (m, 1H), 4.90-4.84 (m, 1H), 5.85-5.81 (m, 1H), 6.00-5.97 (m, 1H) ppm.

General procedure in absence of Copper

Olefin (0.424 mmol) was added to a mixture of nitro compound (1.06 mmol) and base (0.0424-0.2124 mmol) in chloroform (1.4 - 0.4 mL) and the mixture magnetically stirred in a sealed vessel at 0-60 °C. After the indicated time the reaction mixture was concentrated and the residue was purified by work up: washed with 5 % HCl (3 × 15 mL portions) and sat. Na₂CO₃ solution (3 × 15 mL portions) or chromatography on silica gel with the indicated eluant.

General procedure in presence of Copper

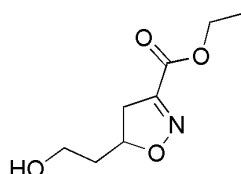
Olefin (0.424 mmol) was added to a mixture of copper (II) acetate or copper (0) (0.0212 mmol), nitro compound (1.06 mmol) and base (0.0424-0.2124 mmol) in chloroform (1.4 - 0.4 mL) and the mixture magnetically stirred in a sealed vessel at 0-60 °C. After the indicated time the reaction mixture was concentrated and the residue was purified by work up: washed with 5 % HCl (3 × 15 mL portions) and sat. Na₂CO₃ solution (3 × 15 mL portions) or chromatography on silica gel with the indicated eluant.

General procedure in presence of Copper and ligand

Olefin (0.424 mmol) was added to a mixture of copper (II) acetate or copper (0) (0.0212 mmol), nitro compound (1.06 mmol) base (0.0424-0.2124 mmol) and ligand (**67-69**) (0.0212-0.1274 mmol) in chloroform (1.4 - 0.4 mL) and the mixture

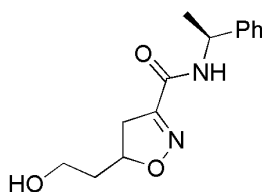
magnetically stirred in a sealed vessel at 60-0 °C. After the indicated time the reaction mixture was concentrated and the residue was purified by work up: washed with 5 % HCl (3 × 15 mL portions) and sat. Na₂CO₃ solution (3 × 15 mL portions) or chromatography on silica gel with the indicated eluant.

Isoxazoline 26 [Ethyl 5-(2-hydroxyethyl)-4,5-dihydro-3-isoxazole-carboxylate]:



The product was dissolved in dichloromethane (1mg/mL) and analysed with gas-chromatography (Beta DEX™ 120 column) with the program **Prog4** (t_1 = 138.2 min, t_2 = 142.1 min).

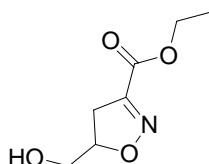
Isoxazoline 48 [5-(2-Hydroxy-ethyl)-4,5-dihydro-isoxazole-3-carboxylic acid (1-phenyl-ethyl)-amide]:



A mixture of **26** (134 mg, 0.716 mmol) and (S)-Phenylethylamine (**47**) (923 μ L, 10 equiv.) was heated under stirring at 60 °C. After 16 h, the mixture was cooled and dissolved in Et₂O (10 mL). The organic phase was washed with 5% HCl (2x5 mL), dried with Na₂SO₄, filtered and concentrated in vacuo. The product was purified by chromatography (ethyl acetate/petroleum ether 2:1; R_f = 0.26), achieved the isoxazoline **48** as a yellowish solid (88 mg, 47%). The product was dissolved in ethyl acetate (1mg/mL) and analysed with gas-chromatography (SEMPPLICITY-5 column) with the program **Prog1** (t_1 = 34.9 min, t_2 = 35.2 min). ¹H NMR: δ = 1.54 (dd, J = 7.2 and 1.2 Hz, 3 H, CH₃), 1.70 (br. s, 1 H, OH), 1.79–

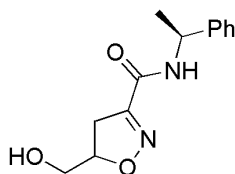
1.87 (m, 1 H, CH₂C-5), 1.91-1.99 (m, 1 H, CH₂C-5), 2.87 - 3.03 (ddd, *J* = 5.0, 8.5 and 17.0 Hz, 1 H, 4-H), 3.26 - 3.43 (ddd, *J* = 5.5, 11.0 and 17.9 Hz, 1 H, 4-H), 3.77-3.85 (m, 2 H, CH₂OH), 4.90-5.02 (m, 1 H, 5-H), 5.12 - 5.20 (pqint, *J* = 7.3 Hz, 1H, CHPh), 6.87 (d, *J* = 1.4 Hz, 1H, NH), 7.30 - 7.36 (m, 5H, Ph-H) ppm. ¹³C NMR: δ = 21.8 (q, 1C, Me), 37.7 (t, 1C, CH₂C-5), 38.7 (t, 1C, C-4), 49.0 (d, 1C, CHPh), 59.4 (t, 1C, CH₂OH), 81.6 (d, 1C, C-5), 126.1 (d, 2C, Ph-C), 127.6 (d, 1C, Ph-C), 128.7 (d, 2C, Ph-C), 142.5 (s, 1C, Ph-C), 154.2 (s, 1C, C-3), 158.8 (s, 1C, C=O) ppm. IR (CDCl₃): ν = 3626 (OH), 3411 (NH), 2932, 1672 (C=O), 1523 (C=N), 1450, 1244 cm⁻¹. MS (EI): *m/z* (%) = 162 (<1) [M]⁺, 247 (3) [M - CH₃]⁺, 217 (9), 132 (24), 120 (100), 105 (30), 77 (18). C₁₄H₁₇N₂O₃ (262.30): calcd. C 64.10, H 6.92, N 10.68; found C 64.40, H 7.20, N 10.86.

Isoxazoline 24 [Ethyl 5-(hydroxymethyl)-4,5-dihydro-3-isoxazolecarboxylate]:



The product was dissolved in dichloromethane (1mg/mL) and analysed with gaschromatography (Beta DEX™ 120 column) with the **Prog5** (*t*₁= 56.7 min, *t*₂= 56.2 min).

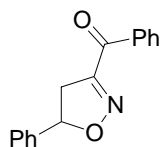
Isoxazoline 49 [5-Hydroxymethyl-4,5-dihydro-isoxazole-3-carboxylic acid (1-phenyl-ethyl)-amide]:



A mixture of **24** (50 mg, 0.289 mmol) and (S)-Phenylethylamine (**47**) (372 μ L, 10 equiv.) was heated under stirring at 60 °C. After 18 h, the mixture was cooled

and dissolved in AcOEt (10 mL). The organic phase was washed with 5% HCl (2x5 mL), dried with Na₂SO₄, filtered and concentrated in vacuo. The product was purified by chromatography, yielding the isoxazoline **49** (38 mg, 15%). The product was dissolved in ethyl acetate (1mg/mL) and analysed with gas-chromatography (SEMPPLICITY-5 column) with the program **Prog2** (t_1 = 43.5 min, t_2 = 44.3 min). Eluant: petroleum ether/ethyl acetate 1:2, R_f = 0.20. White solid. ¹H NMR: δ = 1.54 (d, J = 6.9 Hz, 3 H, CH₃), 1.89 (br. s, 1 H, OH), 3.13-3.29 (m, 2 H, 4-H), 3.64 (dt, J = 4.8 and 12.4 Hz, 1 H, CHOH), 3.80 (dq, J = 3.2 and 12.6 Hz, 1 H, CHOH), 4.83-4.91 (m, 1 H, 5-H), 5.15 (pquint, J = 7.2 Hz, 1H, CHPh), 6.88 (d, J = 8.2 Hz, 1H, NH), 7.26 - 7.34 (m, 5H, Ph-H) ppm. ¹³C NMR: δ = 21.6 (q, 1C, CH₃), 34.5 (t, 1C, C-4), 48.8 (d, 1C, CHPh), 63.1 (t, 1C, CH₂OH), 83.3 (d, 1C, C-5), 125.8 (d, 2C, Ph-C), 127.3 (d, 1C, Ph-C), 128.4 (d, 2C, Ph-C), 142.1 (s, 1C, Ph-C), 154.1 (s, 1C, C-3), 158.2 (s, 1C, C=O) ppm. IR (CDCl₃): ν = 3602 (OH), 2976, 1673 (C=O), 1523 (C=N), 1245 cm⁻¹. MS (EI): m/z (%) = 248 (<1) [M]⁺, 233 (12) [M-Me]⁺, 217 (19), 128 (28), 120 (100), 105 (38), 77 (21). C₁₃H₁₆N₂O₃ (248.28): calcd. C 62.89, H 6.50, N 11.28; found C 62.31, H 6.50, N 10.90.

Isoxazoline 9 [Phenyl-(5-phenyl-4,5-dihydro-isoxazol-3-yl)-methanone]:¹⁷

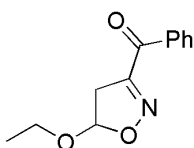


The product was dissolved in dichloromethane (1mg/mL) and analysed with gas-chromatography (Beta DEXTM 120 column) with the program **Prog6** (t_1 = 164.2 min, t_2 = 165.6 min). Yellow oil¹²⁷. 106 mg, 100% (Work-up with 5% HCl (2x5 mL)). ¹H NMR δ = 3.38 (dd, J = 8.8 e 17.8 Hz, 1 H, H-4), 3.77 (dd, J = 11.4 e 17.8 Hz, 1 H, H-4), 5.76 (dd, J = 8.8 e 11.4 Hz, 1 H, H-5), 7.29 - 7.41 (m, 5 H, Ar-H), 7.48 (m, 2 H, Ar-H), 7.61 (m, 1 H, Ar-H), 8.24 (m, 2 H, COPh-*H*_{ortho}), ppm. ¹³C

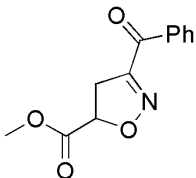
¹²⁷ S. Kanemasa, H. Matsuda, A. Kamimura, T. Kakinami, *Tetrahedron*, **2000**, *56*, 1057

NMR δ = 41.8 (t, C-4), 84.2 (d, C-5), 125.9 (d, 2 C, Ar-C), 128.4 (d, 2 C, Ar-C), 128.6 (d), 128.8 (d, 2 C, Ar-C), 130.3 (d, 2 C, Ar-C), 133.6 (d), 135.7 (s, Ar-C), 139.7 (s, Ar-C), 157.4 (s, C=N), 186.2 (s, C=O), ppm. MS (EI): m/z (%) = 251 (25) [M]⁺, 234 (12), 205 (4), 204 (4), 105 (100) [PhCO]⁺, 77 (55) [Ph]⁺. IR (CDCl₃): 3068, 3030, 2926, 2857, 1672, 1652, 1599, 1581, 1572 cm⁻¹. elemental analysis calcd (%) for C₁₆H₁₃NO₂ (251.28): C 76.48, H 5.21, N 5.57; found: C 76.50, H 5.29, N 5.44.

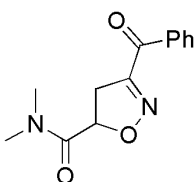
Isoxazoline 59 [(5-Ethoxy-4,5-dihydroisoxazol-3-yl)-phenyl-methanone]:



The product was dissolved in dichloromethane (1mg/mL) and analysed with gas-chromatography (Beta DEXTM 120 column) with the program **Prog4** (t_1 = 153.4 min, t_2 = 160.1 min). Clear oil. 33 mg, 35% (Eluent: Hexane/Diethyl ether 7:1; R_f = 0.30). ¹H NMR δ = 1.23 (t, J = 7.2 Hz, 3 H, CH₃), 3.22 (dd, J = 2.0 and 16.8 Hz, 1 H, H-4), 3.36 (dd, J = 6.8 and 16.0 Hz, 1 H, H-4), 3.64 (m, 1 H, CH₂O), 3.92 (m, 1 H, CH₂O), 5.69 (dd, J = 1.6 and 6.8 Hz, 1 H, H-5), 7.43 - 7.47 (m, 2 H, Ar-H), 7.56 - 7.60 (m, 1 H, Ar-H), 8.18 - 8.21 (m, 2 H, Ar-H) ppm. ¹³C NMR δ = 14.9 (q, 1 C, CH₃), 40.6 (t, 1 C, C-4), 64.5 (t, 1 C, CH₂O), 104.2 (d, C-5), 133.4 (d, 1 C, Ar-C), 133.7 (d, 1 C, Ar-C), 135.2 (d, 1 C, Ar-C), 135.6 (d, 1 C, Ar-C), 157.9 (s, 1 C, C=N), 185.9 (s, C=O), ppm. MS (EI): m/z (%) = 219 (25) [M]⁺, 174 (11) [M - OEt], 143 (31), 115 (13), 105 (100) [PhCO]⁺, 77 (57) [Ph]⁺, 51 (31).

Isoxazoline 60 [3-Benzoyl-4,5-dihydro-isoxazole-5-carboxylic acid methyl ester]:

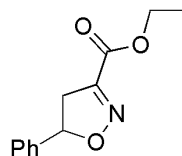
The product was dissolved in dichloromethane (1mg/mL) and analysed with gas-chromatography (Beta DEX™ 120 column) with the program **Prog6** ($t_1=103.7$ min, $t_2=104.4$ min). Yellow oil, 82 mg, 83% (Work-up with 5% HCl (2x5 mL)). $^1\text{H NMR}$ $\delta = 3.69$ (m, 2 H, H-4), 3.84 (s, 3 H, CH₃), 5.21 (m, 1 H, H-5), 7.51 - 7.61 (m, 2 H, Ar-H), 8.05 - 8.10 (m, 1 H, Ar-H), 8.19 - 8.25 (m, 2 H, Ar-H) ppm.

Isoxazoline 61 [3-Benzoyl-4,5-dihydro-isoxazole-5-carboxylic acid dimethylamide]:⁵

The product was dissolved in dichloromethane (1mg/mL) and analysed with gas-chromatography (Beta DEX™ 120 column) with the program **Prog6** (the peaks were not resolved). Pale-yellow oil, 104mg, 99% (Work-up with 5% HCl (2x5 mL) and sat. Na₂CO₃ solution (2x5 mL)). $^1\text{H NMR}$: $\delta=3.00$ (s, 3H; CH₃), 3.18 (s, 3H; CH₃), 3.44 (dd, $J=11.7, 17.8$ Hz, 1H; 4-H), 4.06 (dd, $J=7.6, 17.8$ Hz, 1H; 4-H), 5.42 (dd, $J=7.6, 11.7$ Hz, 1H; 5-H), 7.40-7.46 (m, 2H; Ph-H_{meta}), 7.54-7.59 (m, 1H; Ph-H_{para}), 8.12-8.16 ppm (m, 2H; Ph-H_{ortho}); $^{13}\text{C NMR}$: $\delta =36.1$ (q; CH₃), 36.5 (t; C-4), 37.2 (q; CH₃), 78.9 (d; C-5), 128.3 (d; 2C; Ph-C_{meta}), 130.3 (d, 2C; Ph-C_{ortho}), 133.6 (d; Ph-C_{para}), 135.6 (s; Ph-C_{ipso}), 157.9 (s; C-3), 166.4(s, Me₂NC=O), 185.8 (s; PhC=O) ppm; IR (CDCl₃): $\nu =3064, 2940, 1658$ (C=O), 1599, 1586 cm⁻¹; MS (EI): m/z (%): 246 (<1) [M]⁺, 216 (2), 174 (12) [M-CONMe₂]⁺, 105 (100)

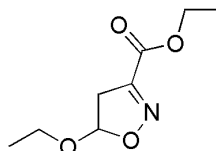
[PhCO]⁺, 77 (52) [Ph]⁺, 72 (74); elemental analysis calcd (%) for C₁₃H₁₄N₂O₃ (246.26): C 63.40, H 5.73, N 11.38; found: C 63.20, H 5.85, N 11.38.

Isoxazoline 10 [ethyl 5-phenyl-4,5-dihydroisoxazole-3-carboxylate]:



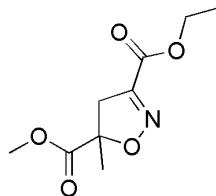
The product was dissolved in DCM (1mg/mL) and analysed with gas-chromatography (Beta DEX™ 120 column) with the **Prog7** (t_1 = 108.7 min, t_2 = 111.8 min). The spectral data are identical to those previously reported.³

Isoxazoline 58 [ethyl 5-ethoxy-4,5-dihydroisoxazole-3-carboxylate]



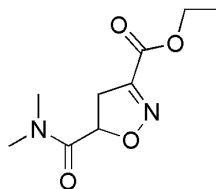
The product was dissolved in DCM (1mg/mL) and analysed with gas-chromatography (Beta DEX™ 120 column) with the **Prog4** (t_1 = 19.8 min, t_2 = 20.6 min). Pale-yellow oil, 78 mg, 98% (Work-up with H₂O (2x5 mL) and 5% Na₂CO₃ solution (2x5 mL)). ¹H NMR δ = 1.23 (t, J = 7.1 Hz, 3 H, CH₃), 1.37 (t, J = 7.1 Hz, 3 H, CO₂CH₂CH₃), 3.05 (dd, J = 2.4 and 18.5 Hz, 1 H, H-4), 3.24 (dd, J = 6.6 and 18.4 Hz, 1 H, H-4), 3.61 (m, 1 H, CH₂O), 3.90 (m, 1 H, CH₂O), 4.36 (q, J = 7.1 Hz, 2 H, CO₂CH₂CH₃), 5.69 (dd, J = 2.4 and 6.6 Hz, 1 H, H-5) ppm.

Isoxazoline 38f [3-ethyl 5-methyl 5-methyl-4,5-dihydroisoxazole-3,5-dicarboxylate]:



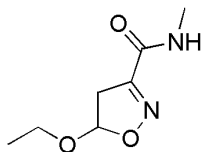
The product was dissolved in DCM (1mg/mL) and analysed with gas-chromatography (Beta DEX™ 120 column) with the **Prog4** (t_1 = 39.1 min, t_2 = 40.0 min).

Isoxazoline 38b [ethyl 5-(dimethylcarbamoyl)-4,5-dihydroisoxazole-3-carboxylate]:



The product was dissolved in DCM (1mg/mL) and analysed with gas-chromatography (Beta DEX™ 120 column) with the **Prog4** (t_1 = 202.6 min, t_2 = 204.7 min).

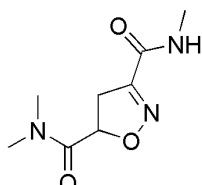
Isoxazoline 62 [5-Ethoxy-N-methyl-4,5-dihydroisoxazole-3-carboxamide]:



The product was dissolved in DCM (1mg/mL) and analysed with gas-chromatography (Beta DEX™ 120 column) with the **Prog4** (t_1 = 35.0 min, t_2 = 35.8 min). Pale-yellow oil, 44 mg, 62% (Work-up with H₂O (2x5 mL) and sat. Na₂CO₃ solution (2x5 mL)). ¹H NMR δ = 1.20 (t, J = 7.1 Hz, 3 H, CH₃), 2.90 (d, J

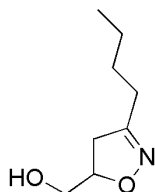
= 5.1 Hz, 3 H, NHCH₃), 3.09 (dd, $J = 2.4$ and 18.6 Hz, 1 H, H-4), 3.25 (dd, $J = 6.5$ and 18.6 Hz, 1 H, H-4), 3.61 (m, 1 H, CH₂O), 3.86 (m, 1 H, CH₂O), 5.69 (dd, $J = 2.4$ and 6.5 Hz, 1 H, H-5), 6.70 (s br, 1 H, NH) ppm.

Isoxazoline 63 [N3,N5,N5-trimethyl-4,5-dihydroisoxazole-3,5-dicarboxamide]:



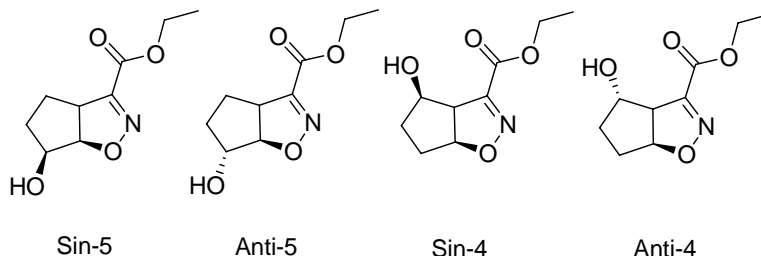
The product was dissolved in DCM (1mg/mL) and analysed with gas-chromatography (Beta DEX™ 120 column) with the **Prog8** ($t_1 = 185.8$ min, $t_2 = 188.8$ min). Clear oil, 69 mg, 100% (Eluant: Ethyl acetate/Hexane 6:1, $R_f = 0.12$). ¹H NMR: $\delta = 2.91$ (d, $J = 5.0$ Hz, 3 H, NHCH₃), 3.00 (s, 3H, NCH₃), 3.15 (s, 3H, NCH₃), 3.34 (dd, $J = 11.6$ and 18.0 Hz, 1 H, H-4), 3.93 (dd, $J = 7.9$ and 18.0 Hz, 1 H, H-4), 5.40 (dd, $J = 7.9$ and 11.6 Hz, 1 H, H-5), 6.61 (s br, 1 H, NH) ppm.

Isoxazoline 66[(3-butyl-4,5-dihydroisoxazol-5-yl)methanol]⁵



The product was dissolved in DCM (1mg/mL) and analysed with gas-chromatography (Beta DEX™ 120 column) with the **Prog4** ($t_1 = 15.1$ min, $t_2 = 15.5$ min). Pale-yellow oil, 19 mg, 66% (Eluant: Ethyl acetate/Hexane 6:1, $R_f = 0.12$). ¹H NMR: $\delta = 0.90$ (t, $J = 7.2$ Hz, 3H; CH₃), 1.29–1.40 (m, 2H; CH₂CH₂CH₃), 1.48–1.56 (m, 2H; CH₂CH₂CH₃), 2.05 (br s, 1H; OH), 2.31 (t, $J = 7.6$ Hz, 2H; CH₂C-3), 2.77–2.83 (m, 1H; 4-H), 2.90–2.97 (m, 1H; 4-H), 3.50–3.56 (m, 1H; CH₂OH), 3.70–3.76 (m, 1H; CH₂OH), 4.59–4.66 (m, 1H; 5-H) ppm.

Isoxazoline 75 [ethyl 4-hydroxy-4,5,6,6a-tetrahydro-3aH-cyclopenta[d]isoxazole-3-carboxylate] and [ethyl 6-hydroxy-4,5,6,6a-tetrahydro-3aH-cyclopenta[d]isoxazole-3-carboxylate]:¹²⁸

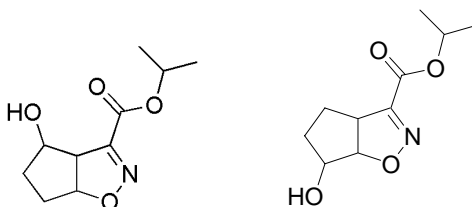


The product was dissolved in DCM (1mg/mL) and analysed with gas-chromatography (SIMPLICITY-5 column) with the **Prog3** ($t_1= 18.4$ min, $t_2= 19.0$ min, $t_3= 19.2$ min, $t_4= 20.8$ min,) and in AcOEt (3mg/mL) with GCMS. Clear oil, 33 mg, 39% (Eluant: Ethyl ether/Hexane 1:1, $R_f = 0.21$).

Sin-5: $^1\text{H NMR}$: $\delta = 1.36$ (t, $J = 7.0$ Hz, 3H), 1.35–1.46 (m, 1 H), 1.76–1.91 (m, 1 H), 1.92–2.02 (m, 2 H), 2.30 (br. s, 1 H), 3.89 (ddd, $J = 2.2, 9.2$ and 9.2 Hz, 1 H), 4.17 (ddd, $J = 5.1, 5.1$ and 10.2 Hz, 1 H), 4.29–4.38 (m, 2 H), 5.02 (dd, $J = 5.1, 9.2$ Hz, 1 H) ppm. **Anti-5:** $^1\text{H NMR}$: $\delta = 1.34$ (t, $J = 7.3$ Hz, 3 H), 1.54 (dddd, $J = 4.4, 7.3, 13.2, 13.2$ Hz, 1 H), 1.79 (ddd, $J = 1.1, 6.2, 13.2$ Hz, 1 H), 1.96 (dd, $J = 7.3, 13.2$ Hz, 1 H), 2.22 (dddd, $J = 6.2, 8.8, 13.2, 13.2$ Hz, 1 H), 2.31 (br. s, 1 H), 3.96 (dd, $J = 8.8, 8.8$ Hz, 1 H), 4.26–4.38 (m, 2 H), 4.36 (dd, $J = 1.1, 4.4$ Hz, 1 H), 4.97 (d, $J = 8.8$ Hz, 1 H) ppm. **Sin-4:** $^1\text{H NMR}$: $\delta = 1.37$ (t, $J = 7.3$ Hz, 3 H), 1.59 (dddd, $J = 7.0, 9.2, 12.4, 12.4$ Hz, 1 H), 1.78–1.92 (m, 1 H), 2.00 (dddd, $J = 2.6, 6.2, 6.2, 12.4$ Hz, 1 H), 2.10–2.20 (m, 1 H), 2.54 (br. s, 1 H), 3.92 (dd, $J = 7.7, 9.2$ Hz, 1 H), 4.34 (q, $J = 7.3$ Hz, 2 H), 4.49 (ddd, $J = 6.2, 7.7, 9.2$ Hz, 1 H), 5.23 (ddd, $J = 1.1, 5.1, 9.2$ Hz, 1 H) ppm. **Anti-4:** $^1\text{H NMR}$: $\delta = 1.36$ (t, $J = 7.0$ Hz, 3 H), 1.64 (dddd, $J = 4.0, 7.0, 13.5, 13.5$ Hz, 1 H), 1.81 (dd, $J = 6.6, 13.5$ Hz, 1 H), 2.13 (dd, $J = 7.0, 13.5$ Hz, 1 H), 2.20–2.33 (m, 1 H), 2.45 (br. s, 1 H), 3.73 (d, $J = 9.2$ Hz, 1 H), 4.28–4.40 (m, 2 H), 4.45 (d, $J = 4.0$ Hz, 1 H), 5.36 (dd, $J = 5.5, 9.2$ Hz, 1 H) ppm.

¹²⁸ P. Conti, M. De Amici, A. Pinto, L. Tamborini, G. Grazioso, B. Frølund, B. Nielsen, C. Thomsen, B. Ebert, C. De Micheli *Eur. J. Org. Chem.* **2006**, 5533–5542.

Isioxazoline 79 [isopropyl 6-hydroxy-4,5,6,6a-tetrahydro-3aH-cyclopenta[d]isoxazole-3-carboxylate] and [isopropyl 4-hydroxy-4,5,6,6a-tetrahydro-3aH-cyclopenta[d]isoxazole-3-carboxylate]:



The product was dissolved in AcOEt (3mg/mL) and analysed with GCMS. Yellow oil, 89 mg, 98% (Work-up with 5% HCl (2x5 mL) and H₂O (2x5 mL)). Mixture of 4 diastereoisomers: ¹H NMR: δ = 1.32 (m, (CH₃)₂CH), 1.64 - 2.02 (m), 3.73 (d, *J* = 10.2 Hz), .,84-4.08 (m), 4.12-4.26 (m), 4.40-4.52 (m), 4.98-5.07 (m), 5.13-5.40 (m) ppm.

Chapter 5

5. Base and Copper Catalysed Condensation of Primary Activated Nitro Compounds with Active Methylene Compounds

5.1. Introduction

Active methylene compounds (those with two geminal EWGs: β -diketones, β -ketoesters, cyanoacetate, etc.) are known to react with hydroximoyl chlorides in the presence of a base to give isoxazole derivatives.¹²⁹ This area was first developed by Quilico and his school in

¹²⁹ D. Giomi, F. M. Cordero, F. Machetti in *Comprehensive Heterocyclic Chemistry III* (Eds.: A. Katritzky, C. Ramsden, E. Scriven, R. Taylor) Elsevier **2008**, pag. 430.

1930's.¹³⁰ They found that benzohydroximoyl chloride reacts with β -diketones and other "active methylene" compounds, only in the presence of base, producing isoxazoles. This reaction was later recognised to take place *via* the intermediate nitrile oxide derived from the corresponding hydroximoyl chloride.¹³¹ These procedures are still in use as a convenient approach to highly functionalised isoxazoles, either from hydroximoyl chlorides^{132, 133} or from isolated nitrile oxides.^{134, 135} Another protocol leads to isoxazoles and isoxazolines using primary nitro compounds as starting materials. These are dehydrated to nitrile oxides with various acylating reagents such as aryl isocyanates,² acyl chlorides,¹³⁶ anhydrides,¹³⁷ POCl₃,¹³⁸ etc. However this protocol is subject

¹³⁰ a) A. Quilico, R. Fusco, *Rend. Ist. Lomb.* **1936**, 69, 439 – 457; b) A. Quilico, R. Fusco *Gazz. Chim. Ital.* **1937**, 67, 589 – 603; c) R. Fusco, *Rend. Ist. Lomb.* **1937**, 70, 225 – 235 d) L. Panizzi *Gazz. Chim. Ital.* **1939**, 69, 322 – 239; e) L. Panizzi *Gazz. Chim. Ital.* **1940**, 70, 89 – 94; f) L. Panizzi *Gazz. Chim. Ital.* **1940**, 70, 119 – 126; g) C. Musante *Gazz. Chim. Ital.* **1939**, 69, 523 – 535; h) A. Quilico, L. Panizzi *Gazz. Chim. Ital.* **1942**, 72, 458 – 474.

¹³¹ A. Quilico, G. Speroni, *Gazz. Chim. Ital.* **1946**, 76, 148 – 166.

¹³² a) A. A. Akhrem, V. A. Khripach, F. A. Lakhvich *Chem. Heterocycl. Compd.* **1974**, 10, 784 – 787; [*Khim. Geterotsikl. Soedin.* **1974**, 901 – 904]; b) K. Tanaka, M. Kishida, S. Maeno, K. Mitsuhashi *Bull. Chem. Soc. Jpn.* **1986**, 59, 2631 – 2632; c) J. Kaminski, Z. Eckstein *Pol. J. Chem.* **1982**, 56, 221 – 228; d) E. B. Tsupak, N. K. Chub, A. M. Simonov, N. M. Miroshnichenko *Chem. Herocycl. Compds.* **1972**, 8, 734 – 737 [*Khim. Geterotsikl. Soedin.* **1972**, 812 – 815]; e) G. L'abbe, G. Mathys, *J. Org. Chem.* **1974**, 39, 1221 – 1225; f) A. K. Roy, S. Batra, *Synthesis*, **2003**, 1347 – 1356; g) A. A. Akhrem, F. A. Lakhvich, V. A. Khripach, A. G. Pozdeyev *Synthesis* **1978**, 43.

¹³³ For recent applications: a) K. Suzuki, H. Takikawa, Y. Hachisu, J. W. Bode *Angew. Chem. Int. Ed.* **2007**, 46, 3252 – 3254; b) M. P. Giovannoni, C. Vergelli, A. Graziano, C. Biancalani, P. Biagini, C. Ghelardini, E. Vivoli, V. Dal Piaz *J. Med. Chem.* **2007**, 50, 3945 – 3953; c) M. P. Giovannoni, C. Vergelli, C. Biancalani, N. Cesari, A. Graziano, P. Biagini, J. Gracia, A. Gavalda, V. Dal Piaz *J. Med. Chem.* **2006**, 49, 5363 – 5371; d) J. W. Bode, Y. Hachisu, T. Matsuura, K. Suzuki *Org. Lett.* **2003**, 5, 391 – 394; e) D. J. Burkhart, P. Zhou, A. Blumenfeld, B. Twamley, N. R. Natale *Tetrahedron*, **2001**, 57, 8039 – 8046.

¹³⁴ a) H. Takikawa, K. Hikita, K. Suzuki *Synlett* **2007**, 2252 – 2256; b) T. Matsuura, J. W. Bode, Y. Hachisu, H. Takikawa, K. Suzuki *Synlett* **2003**, 1746 – 1748; c) J. W. Bode, Y. Hachisu, T. Matsuura, K. Suzuki *Tetrahedron Lett.* **2003**, 44, 3553 – 3558; d) K. B. Umesha, K. Ajay Kumar, K. M. Lokanatha Rai *Synth. Commun.* **2002**, 32, 1841 – 1846.

¹³⁵ For recent applications: a) Y. Koyama, R. Yamaguchi, K. Suzuki, *Angew. Chem., Int. Ed.* **2008**, 47, 1084 – 1087; b) Y. Hachisu, J. W. Bode, K. Suzuki *J. Am. Chem. Soc.* **2003**, 125, 8432 – 8433. c) J. W. Bode, K. Suzuki *Tetrahedron Lett.* **2003**, 44, 3559 – 3563.

¹³⁶ a) E. Kaji, K. Harada, S. Zen, *Chem. Pharm. Bull.* **1978**, 26, 3254 – 3256; b) K. Harada, E.

to a drawback if applied to enolic dipolarophiles, because the reagents commonly used as dehydrating agents react with these dipolarophiles.^{139,140,141} Therefore this approach to the direct preparation of isoxazoles has been largely ignored. A single example reports treatment of dibenzoylmethane with excess of phenylnitromethane and acetyl chloride in basic conditions to yield 4-benzoyl-3,5-diphenylisoxazole among other products.¹⁴² In order to overcome this difficulty, a procedure has been proposed that involves the use of preformed pyrrolidine enamines of substituted β -keto esters,^{143, 144} or β -diketones,¹⁴⁵ thus adding a further step to the whole process.

Kaji, S. Zen, *Chem. Pharm. Bull.* **1980**, *28*, 3296 – 3303.

¹³⁷ A. Mckillop, R. J. Kobylecki *Tetrahedron* **1974**, *30*, 1365 – 1371.

¹³⁸ a) G. B. Bachman, L. E. Strom *J. Org. Chem.* **1963**, *28*, 1150 – 1152; b) J. E. McMurry *Org. Synth.* **1973**, *53*, 59 – 62.

¹³⁹ For reactions of aryl isocyanates with compounds containing active methylene groups in presence of an organic base see for example a) O. A. Linchenko, P. V. Petrovskii, I. Yu. Krasnova, V. N. Kalinin, Z. A. Starikova, Yu. G. Gololobov *Russ. Chem. Bull. Int. Ed.* **2006**, *55*, 873 – 878. [*Izv. Akad. Nauk. Ser. Khim.* **2006**, 844 – 849]; b) Yu. G. Gololobov, O. A. Linchenko, I. R. Gol'ding, M. A. Galkina, I. Yu. Krasnova, I. A. Garbuzova, P. V. Petrovskii, *Russ. Chem. Bull. Int. Ed.* **2005**, *54*, 2398 – 2405 [*Izv. Akad. Nauk, Ser. Khim.* **2005**, 2323 – 2330]; c) L. Capuano, P. Boschhat, H. W. Heyer, G. Wachter *Chem. Ber.* **1973**, *106*, 312 – 316; d) L. Capuano, R. Zander, *Chem. Ber.* **1973**, *106*, 3670 – 3673.

¹⁴⁰ For reaction of acyl chlorides with compounds containing active methylene groups in presence of an organic base see for example: a) A. A. Akhrem, F. A. Lahkvich, S. I. Budai, T. S. Khlebnicova, I. I. Petrushevich *Synthesis*, **1978**, 925 – 927; b) J.-M. Wang, T. Asami, F.-S. Che, N. Murofushi, S. Yoshida *J. Agric. Food Chem.* **1997**, *45*, 2728 – 2734.

¹⁴¹ For reaction of anhydrides with compounds containing active methylene groups in presence of an organic base see for example: H.-G. Henning, G. Mazunaitis, *Monatsh. Chem.* **1992**, *123*, 93 – 98.

¹⁴² S. Zen, K. Harada, H. Nakamura, Y. Iitaka *Bull. Chem. Soc. Jpn.* **1988**, *61*, 2881 – 2884.

¹⁴³ a) G. Stork, J. M. McMurry *J. Am. Chem. Soc.* **1967**, *89*, 5461 – 5462; b) J. M. McMurry *Org. Synth.* **1973**, *53*, 59.

¹⁴⁴ For other examples see a) R. C. F. Jones, G. Bhalay, P. A. Carter, K. A. M. Duller, S. I. E. Vulto *J. Chem. Soc., Perkin Trans. 1* **1994**, 2513 – 2515; b) R. C. F. Jones, G. Bhalay, P. A. Carter, K. A. M. Duller, S. I. E. Vulto *Synlett* **1995**, 149 – 150; c) R. C. F. Jones, K. A. M. Duller, S. I. E. Vulto *J. Chem. Soc., Perkin Trans. 1* **1998**, 411 – 416; d) R. C. F. Jones, G. Bhalay, P. A. Carter, K. A. M. Duller, S. H. Dunn *J. Chem. Soc., Perkin Trans. 1* **1999**, 765 – 776; e) V. A. Moorthie, E. M. McGarrigle, R. Stenson, V. K. Aggarwal *Arkivoc*, **2007**, (v), 139 – 151.

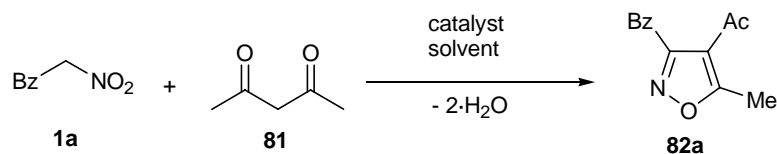
¹⁴⁵ a) S. Zen, K. Harada, H. Nakamura, Y. Iitaka *Bull. Chem. Soc. Jpn.* **1988**, *61*, 2881 – 2884; b) P. Weimin, Z. Shizheng, J. Guifang *Tetrahedron* **2001**, *57*, 5781 – 5784.

In this chapter the application of the catalytic procedure to “activated” primary nitro compounds with active methylene compounds as dipolarophiles is described. Attempted reactions of nitroalkanes with these dipolarophiles were unsuccessful.

5.2. Results and Discussion

Using the model reaction between benzoynitromethane (**1a**) and acetylacetone (**81**) conditions for isoxazole formation were investigated. The reaction has been monitored with various catalyst compositions and solvents and the spectroscopic yields observed after an established time are reported in Table 5-1.

The base alone as a catalyst is unsatisfactory, as poor yields of the expected isoxazole **82a** are obtained (entries 2, 5, 6, 8). Higher isoxazole yields are obtained on addition of copper(II) to the base (entries 1, 3, 4, 7): the best results are achieved with a catalyst loading 20 % base and 10% copper(II) (*cf.* entries 3 and 4). *N*-Methylpiperidine (NMP, **3c**) is to be preferred among the bases (*cf.* entries 1, and 3, 11, 12). Similar results are obtained using copper(II) acetylacetonate instead of copper(II) acetate (entry 9) or instead of acetylacetone (**81**) (entry 10). No isoxazole **82a** is produced in the presence of copper(II) alone (entry 13). Attempted use of other solvents shows that a protic solvent (ethanol, entry 14) does not favour the reaction, while in toluene the model reaction gives an excellent result (entry 15).

Table 5-1. Optimization of reaction conditions on the model reaction between benzylnitromethane (**1a**) and acetylacetone (**81**).^[a]

Entry	Solvent	Catalyst		Yield ^[b]
		Base (equiv)	Cu(II) (equiv)	
1	CHCl ₃	DABCO (0.2)	0.1 ^[c]	53(62)
2	CHCl ₃	DABCO (0.2)	-	trace(4)
3	CHCl ₃	NMP (0.2)	0.1 ^[c]	73(73)
4	CHCl ₃	NMP (0.1)	0.05 ^[c]	57(67)
5	CHCl ₃	NMP (0.2)	-	6(6)
6	CHCl ₃	NMP (0.1)	-	14(20)
7	CHCl ₃	DABCO (0.1)	0.05 ^[c]	51(58)
8	CHCl ₃	DABCO (0.1)	-	6(6)
9	CHCl ₃	NMP (0.2)	0.1 ^[d]	54(62)
10	CHCl ₃	NMP (0.2)	0.1 ^[c] (1.1) ^[e]	85 ^[f]
11	CHCl ₃	NMI (0.2)	0.1 ^[c]	12(18)
12	CHCl ₃	TEA (0.2)	0.1 ^[c]	49(50)
13	CHCl ₃	-	0.1	0
14	C ₂ H ₅ OH	NMP (0.2)	0.1 ^[c]	trace
15	Toluene	NMP (0.2)	0.1 ^[c]	78(90)

[a] Reaction conditions: 60 °C. See experimental section for details. [b] Spectroscopic yield evaluated by NMR after 18 hours. In parentheses spectroscopic yield after 42 hours (but after 72 h for entry 15). [c] Cu(AcO)₂. [d] Cu(Acac)₂ [e] Cu(Acac)₂ instead of acetylacetone. [f] Possibly excessive value, owing to signal broadening caused by high copper concentration.

However for other substrates (nitroacetates **1b** and **1j**) chloroform is preferred. Thus, Cu(II) salt (0.1 equiv) with NMP (**3c**) (0.2 equiv) has

been employed as a catalyst, in chloroform for reactions of **1b**, **1g**, **1j**, but in toluene for **1a**.

One of these reactions (entry 3 in Table 5-1) has been followed by ^1H NMR and the kinetic profiles, illustrated in Figure 5-1, report the concentration versus time of the product **82a** and of nitromethane, formed by slow cleavage of benzonitromethane **1a**. Nitromethane is produced together with benzoic acid: this reacts with the basic catalyst, thus the rate is reduced, even in the presence of excess of starting material **1a**.

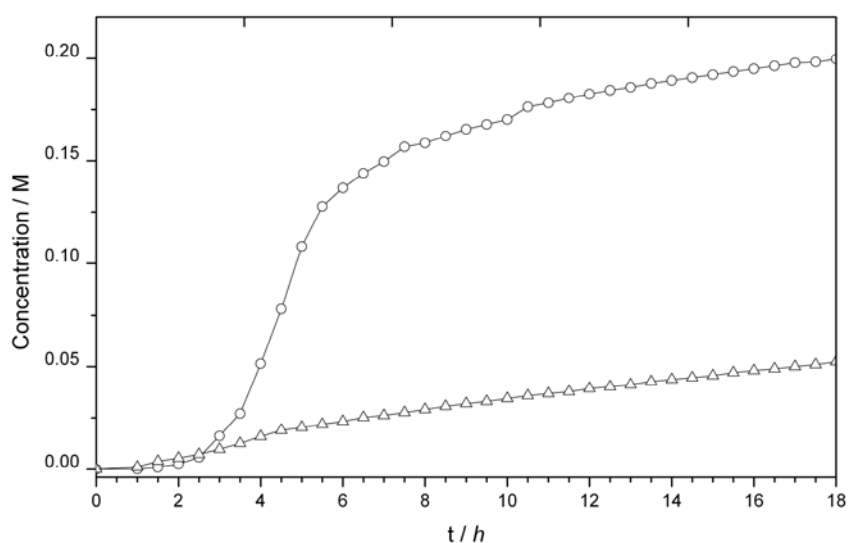
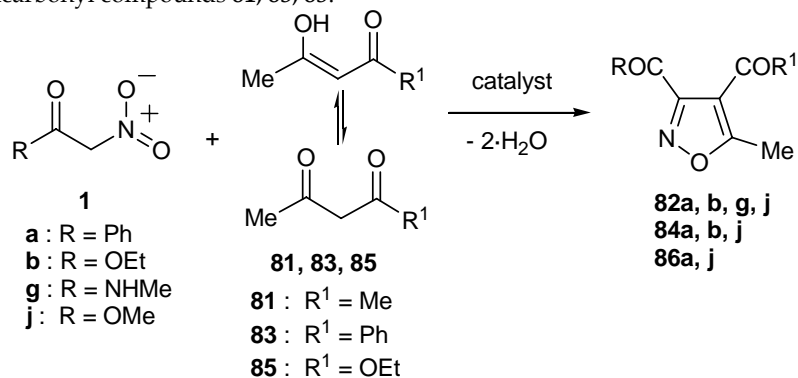


Figure 5-1. Kinetic profiles of the reaction between benzonitromethane **1a** and acetylacetone **81**, in the conditions of entry 3 in Table 5-1, have been obtained by plotting versus time the concentrations of the product **82a** (circles) and of nitromethane (triangles), measured by ^1H NMR spectroscopy.

Ethyl nitroacetate (**1b**), methyl nitroacetate (**1j**), *N*-methylnitroacetamide (**1g**) and benzonitromethane (**1a**) with acetylacetone (**81**) respectively yield the 4-acetylisoxazoles **82b**, **82j**, **82g** and **82a**. Similarly, the nitroacetates **1b** and **1j** and the nitroketone **1a** with benzoylacetone **83** give the regioisomers **84b**, **84j** and **84a**, respectively.

Benzoylnitromethane (**1a**) and methyl nitroacetate (**1j**) also react with ethyl acetoacetate (**85**) leading to the isoxazoles **86a** and **86j**, respectively.

Table 5-2. Substituted isoxazoles from nitro compounds **1a-b**, **1g**, **1j** and 1,3-dicarbonyl compounds **81**, **83**, **85**.^[a]



Entry	R	R ¹	Product	Yield[%] ^[b]	Lit.
1	OEt	Me	82b	48	44 ^[c]
2	OMe	Me	82j	66	30 ^[d]
3	MeNH	Me	82g	35(41) ^[f]	-
4	Ph	Me	82a	85	-
5	OEt	Ph	84b	65(82) ^[f]	32 ^[e]
6	OMe	Ph	84j	75	29 ^{[d],[h]}
7	Ph	Ph	84a	93	-
8	OMe	OEt	86j	29	25 ^[d]
9	Ph	OEt	86a	25	32 ^[g]

[a] See experimental section for details. [b] Isolated yields determined on analytically pure product and based on dipolarophile. [c] Ref.¹⁴⁶ [d] Ref.¹⁴⁷ [e]

¹⁴⁶ D. J. Burkhart, P. Zhou, A. Blumenfeld, B. Twamley, N. R. Natale, *Tetrahedron* **2001**, 57, 8039 – 8046.

¹⁴⁷ T. Shimizu, Y. Hayashi, K. Teramura *Bull. Chem. Soc. Jpn.* **1985**, 58, 2519 – 2522.

Ref.^{148,149} [f] In parentheses the yield considering the recovered diketone. [g]
Ref.^{148,150} [h] Another isomer was also present in 43%.

The results are summarised in Table 5-2: no other regioisomers have been identified, in addition to products **82**, **84** and **86** illustrated. The reported yields favourably compare with those of previous methods (last column), which however require an additional step. Methyl nitroacetate (**1j**) has been chosen to obtain simpler ¹H NMR spectra of crude mixtures. It turned out that these reactions give better results than those of the ethyl ester (**1b**) (compare entries 1 and 2, 5 and 6). Thus methyl nitroacetate (**1j**) is preferred for the preparation of isoxazoles bearing on C-3 a carboxylate functionality. The isoxazole **84j** is obtained selectively among four possible isomers. The structure **84j** was assigned by ¹³C combined with long range C-H correlation (gHMBC) NMR analysis (see Figure A-5 and A-6 in Appendix). In a previous cycloaddition procedure this isomer was isolated as a minor product (29%) beside 4-acetyl-3-ethoxycarbonyl-5-phenylisoxazole (43%).¹¹

This double condensation catalysed by copper (II) was found to proceed smoothly with β -diketones; whereas for ethyl acetoacetate (**85**) the conversions (entries 8 and 9) observed by ¹H NMR are less than 30%. Even by raising the reaction temperature or prolonging the reaction time the ethyl acetoacetate (**85**) did not react more completely. Changing the solvent (toluene instead of chloroform) or further addition of more nitro compound and catalyst did not increase the conversion. Substoichiometric addition of a second base, such as pyrrolidine, only slightly increased the yields.

¹⁴⁸ V. Sprio, E. Aiello, A. Mazza *Ann. Chim. (Rome)* **1967**, 57, 836 – 845.

¹⁴⁹ N. Levin, W. H. Hartung *Org. Synth.* **1944**, 24, 25 – 28.

¹⁵⁰ H. Suzuki, H. Shimizu, T. Inamasu, H. Tani, R. Tamura *Chem. Lett.* **1990**, 559 – 562.

Beside the reported isoxazole derivatives **82**, **84** and **86**, in reactions of **1a**, **1b** and **1j**, the furoxans **87a**, **87b** and **87j** respectively have been detected. In the presence of base and moisture, heating at 60° causes cleavage of all these compounds to some extent, depending on base concentration.¹¹ For this reason the furoxan **87b** was not detected in the previous experiments¹⁵¹ on reactions of **1b** with other dipolarophiles and DABCO (**3**) (0.2 equiv). The reaction conditions here reported (NMP, **3c**, 0.08 equiv) highlight the presence of furoxan. In the absence of other dipolarophiles, fair yields of the furoxans **87b** (43%) and **87j** (68%) are obtained. This procedure appears to be of synthetic interest and is convenient, compared to the known preparation methods of these compounds.^{152,153}

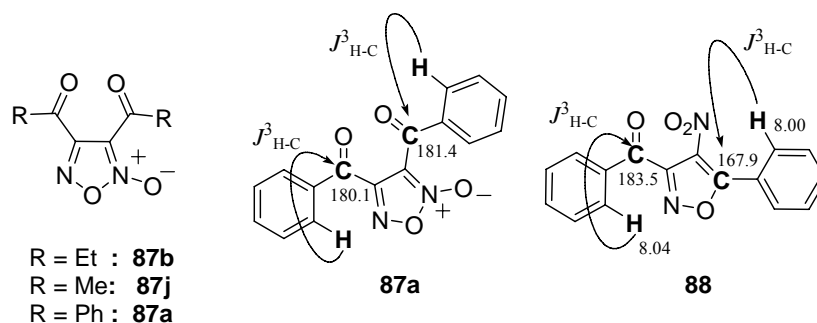


Figure 5-2. Structure of self-condensation products and key assignments in **87a** and **88** of the quaternary carbon atoms based on long-range ¹³C / ¹H correlations (see Figure A-7 and A-8 in Appendix).

In reactions of the nitro ketone **1a**, an isomer of the furoxan **87a** (Figure 5-2) has been detected and identified as 3-benzoyl-4-nitro-5-

¹⁵¹ L. Cecchi, F. De Sarlo, F. Machetti *Tetrahedron Lett.* **2005**, 46, 7887 – 7879.

¹⁵² A. B. Sheremetev, N. N. Makhova, W. Friedrichsen, *Adv. Heterocycl. Chem.* **2001**, 78,65– 188.

¹⁵³ For biological aspects of these compounds see: a) H. Cerecetto W. Porcal *Mini-Reviews in Medicinal Chemistry*, **2005**, 5, 57 – 71; b) *Bioactive Heterocycles IV. Topics in Heterocyclic Chemistry*, 10. (Eds.: M. Tareq, H. Khan) Springer **2007**, chapter nine.

phenylisoxazole (**88**) on the basis of spectral evidence and crystallographic analysis (Figure 5-3). Compound **88** was analysed by NMR spectroscopy and distinguished from the isomer **87a** mainly on the basis of ^{13}C NMR chemical shift considerations and long-range C-H connectivity (gHMBC) analysis (Figure 5-2 and Figure A-7-A-8 in Appendix).

The crystal structure of **88** is shown in the ORTEP diagram (Figure 5-3). The same compound had been previously obtained by reacting benzonitromethane (**1a**) with the appropriate hydroximoyl chloride and triethylamine:¹⁵⁴ the reported m. p. 100 - 101°C and IR absorptions at 1680 and 835 cm^{-1} are in agreement with the properties of **88**.

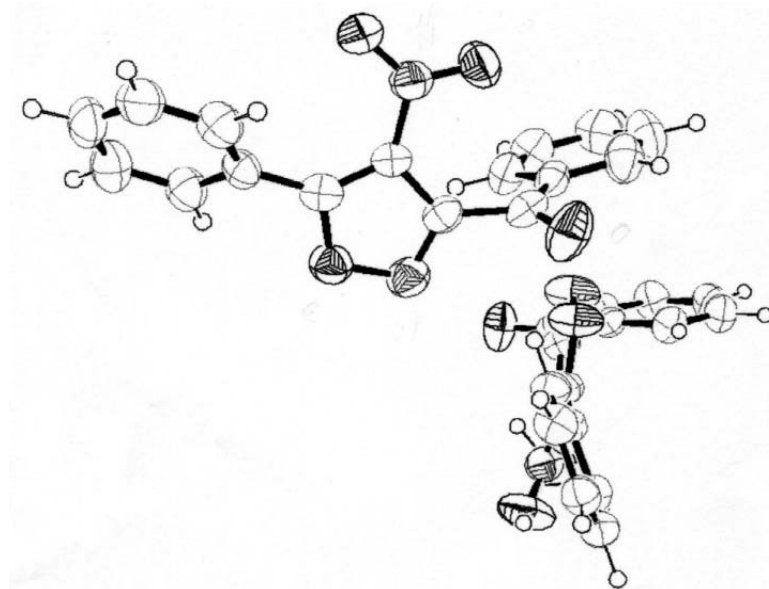


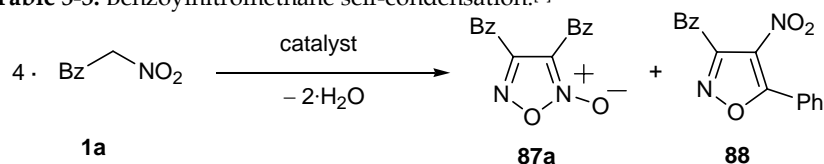
Figure 5-3. X-ray crystal structure of **88**.

Samples of **87a** and of **88** were submitted to prolonged treatment in the reaction conditions, thus verifying that the two isomers do not convert

¹⁵⁴ V. Dal Piaz, S. Pinzauti, P. Lacrimini *Synthesis* **1985**, 664 - 665.

to one another. When benzylnitromethane (**1a**) alone is treated with catalyst, both products of self-condensation are obtained: the rate of self-condensations and molar ratios depend on catalyst composition and concentration (Table 5-3). After 18 h, no residual **1a** is observed if Cu(II) is present: reactions are slower in the presence of the sole base. However the overall yield of the self-condensation products **87a** and **88** is far from quantitative, considerable amounts of benzoic acid and nitromethane being identified in the ^1H NMR spectrum of the crude reaction mixtures.

Table 5-3. Benzylnitromethane self-condensation.^[a]



Entry	Catalyst		1a : 87a : 88 ^[b]
	Base (mmol-%)	Cu(II) (mmol-%)	
1	DABCO (4)	2	0 : 37 : 63
2	DABCO (4)	-	8 : 30 : 62
3	NMP (4)	2	0 : 61 : 39
4	NMP (4)		42 : 30 : 28
5	DABCO (8)	4	0 : 0 : 100
6	DABCO (8)	-	11 : 0 : 89
7	NMP (8)	4	0 : 34 : 66

[a] Reaction conditions: 18 h, 60 °C, CDCl_3 . See experimental section for more details. [b] Molar ratios evaluated by NMR.

Moreover benzoic acid is found in molar excess with respect to nitromethane, because it originates from cleavage not only of the s.m. **1a** but of the furoxan **87a** as well. The presence of the furoxans of **87a**, **87b** and **87j** indicates formation of their precursors, the corresponding nitrile

5.3. Conclusions

This study was aimed to the development of a new method, rather than of specific targets: only some of the many possible substrates are reported as selected examples. Functionalised 5-methylisoxazoles are regioselectively obtained by water release, using the convenient and economical Cu(OAc)₂-NMP catalytic system, thus avoiding the preliminary synthesis of hydroximoyl chlorides.

In addition to the mechanism illustrated in previous papers¹¹ the cycloaddition-condensation process on “activated” primary nitro compounds might even take place, at least in part, *via* intermediate nitrile oxides, since the corresponding dimers furoxans are produced in the absence of dipolarophiles. Reactions of nitroalkanes only occur with Cu(II) + base catalyst and no furoxans have been detected.

5.4. Experimental section

General methods: For the instruments used and other details see Experimental Section in Chapter 2. All compounds were named with Autonom[®] (Beilstein Information Systems) and modified where appropriate.

Materials: Commercially available (Lancaster and Aldrich) nitroacetates (**1b**; **1j**), benzoynitromethane (**1a**), organic bases and enolisable compounds **2** - **4** are used as supplied. CHCl₃ (ethanol free) was filtered through a short pad of potassium carbonate just before use. *N*-methyl-2-nitroacetamide (**1c**) was prepared according to reported procedure.¹¹

The spectral data for the furoxan **87a** are identical to those previously reported.¹⁷

Optimisation of isoxazole formation from acetylacetone (81) and benzoylnitromethane (1a) (Table 5-1).

Various catalytic systems were screened in different solvents. The most significant results are reported in Table 5-1. The spectroscopic yields reported in Table 5-1 refer to reactions performed in an apparatus where eight reactions were carried out simultaneously. Benzoylnitromethane (**1a**) (1.06 mmol), acetylacetone (**81**) or copper(II) acetylacetonate for entry 10 (0.424 mmol) and dimethylsulphone (Me₂SO₂) (**42**) (10 - 13 mg, 0.106 - 0.138 mmol) as internal standard were added to the catalyst [base (0.0848 or 0.0424 mmol, 0.2 and 0.1 equiv respectively), or base (0.0848 or 0.0424 mmol) and copper(II) acetate or copper(II)acetylacetonate for entry 9 (0.0424 or 0.0212 mmol, 0.1 and 0.05 equiv respectively)] and the mixture dissolved in the indicated solvent (1.4 mL). The mixture was kept at 60 °C. After 18h and 42 h, a portion was withdrawn from the reaction mixture, diluted with CDCl₃ (0.6mL) and the ¹H NMR spectrum registered. Integration of the methyl proton signal (singlet at 2.99 ppm, 6 H) of internal standard and acetyl protons of isoxazole **82a** (singlet at 2.75 ppm, 3 H) gave the spectroscopic yields. Evaluations of the conversions were unreliable and the values were not reported. In case of an unclear result, a duplicate experiment was run.

Effect of different catalyst compositions on benzoyl- nitromethane (1a) self-condensation products. (Table 5-3).

Different catalytic systems were screened by using the same apparatus as above. The most significant results are reported in Table 5-2.

Copper and base. Copper (II) acetate (0.021 mmol or 0.042 mmol) was added to a solution of benzoylnitromethane (**1a**) (176 mg, 1.06 mmol, 0.76 M) and base (0.042 or 0.084 mmol; 0.03 and 0.06 M respectively) in CDCl₃ (1.4 mL) and the mixture magnetically stirred in a sealed vessel at 60 °C. After 18 h the molar ratio **1a** : **87a**³ : **88** was evaluated by ¹³C NMR (see later).

Base alone. A solution of benzoylnitromethane (**1a**) (176 mg, 1.06 mmol, 0.76 M) and base (0.042 or 0.084 mmol; 0.03 or 0.06 M respectively) in CDCl₃ (1.4 mL) was magnetically stirred in a sealed vessel at 60 °C. After 18 h the molar ratio **1a** : **87a** : **88** was evaluated by ¹³C NMR (see later). Evaluation of molar ratio. A solution of weighed amounts of compounds **1a**, **87a**, **88** was prepared, the ¹³C NMR spectrum (Standard ¹³C experiment, 100.57 MHz, d1 = 1s, CDCl₃) registered and the intensity of selected signals at 186.1 ppm (**1a**), 181.4 ppm (**87a**) and 183.5 ppm (**88**) were compared. Thus the expected molar ratios were obtained with a correction factor of 1.16 and this was then applied to evaluate molar ratios from spectra registered in the same conditions.

Experiments of stability of 87a and 88 in the reaction conditions.

Compounds **87a** and **88** were submitted to several experiments in order to establish whether they interconvert each other or transform in other compounds. Experiments were run in a septum-sealed 5 mm NMR tube heating the reaction mixture (0.7 mL, CDCl₃) at 60 °C for 18 h in the presence of Me₂SO₂ (**42**) as internal standard and checked by NMR. Benzoic acid has been identified also by MS spectroscopy.

Experiment a: A solution of **87a** (12 mg, 0.039 mmol, 0.06M), NMP (**3c**) (3 μL, 0.021 mmol, 0.03 M) and Cu(AcO)₂ (1.95 mg, 0.011mmol, 0.015 M) showed by spectroscopic analysis a partial decomposition of **87a** in benzoic acid.

Experiment b: A solution of **87a** (11 mg, 0.037 mmol, 0.05 M), DABCO (**3**) (2.2 mg, 0.020 mmol, 0.03 M) and Me₂SO₂ (**42**) (4 mg, 0.042 mmol) showed by spectroscopic analysis a partial decomposition of **87a** in benzoic acid.

Experiment c: A solution of **87a** (5.6 mg, 0.019 mmol), **88** (5.7 mg, 0.019 mmol) and Me₂SO₂ (**42**) (3.5 mg, 0.037 mmol) showed by spectroscopic analysis a partial transformation in benzoic acid. No interconversion between **87a** and **88** was observed.

Experiment d: A solution of **88** (35 mg, 0.119 mmol, 0.17 M), DABCO (**3**) (4.7 mg, 0.042 mmol, 0.06 M) and Me₂SO₂ (**42**) (4 mg, 0.042 mmol) showed by ¹H NMR

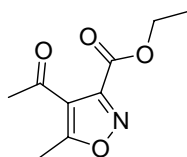
and ^{13}C NMR neither conversion to compound **87a** nor transformation in other compounds.

Experiment e: A solution of **88** (35 mg, 0.119 mmol, 0.17 M), NMP (**3c**) (5 μL , 0.042 mmol, 0.06M), $\text{Cu}(\text{AcO})_2$ (3.8 mg, 0.021mmol, 0.03 M) and Me_2SO_2 (**42**) (5.2 mg, 0.055 mmol) showed by ^1H NMR and ^{13}C NMR neither conversion to compound **87a** nor transformation in other compounds.

General procedure for the preparation of isoxazoles **82**, **84** and **86**.

Nitro compound (1.06 mmol), dipolarophile (0.424 mmol) and NMP (**3c**) (10 μL , 0.08 mmol) were added in sequence to a suspension of $\text{Cu}(\text{OAc})_2$ (7.8 mg, 0.042 mmol) in the indicated solvent (1.4 mL). The stirred mixture was heated in a sealed tube at 60 $^\circ\text{C}$ and maintained under stirring for the indicated time. The solvent was then removed under vacuum and the crude material was purified by column chromatography on silica gel with the indicated eluant.

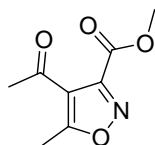
Reaction between acetylacetone (**81**) and ethyl nitroacetate (**1b**): 4-acetyl-5-methyl-isoxazole-3-carboxylic acid ethyl ester (**82b**)



Treatment of **81** (43 mg) with **1b** (141 mg) by the general procedure gave **82b** (40 mg, 48 %) as a colourless oil after 72 h (CHCl_3) and chromatographic purification (elution with hexane/ AcOEt 5:1; $R_f = 0.22$). ^1H NMR: $\delta =$, 1.39 (t, $J = 7.2$ Hz, 3 H, OCH_2CH_3), 2.46 (s, 3 H, CH_3CO), 2.63 (s, 3 H, $\text{CH}_3\text{C}-5$), 4.44 (q, $J = 7.2$ Hz, 2 H, OCH_2CH_3) ppm.^[26] ^{13}C NMR: $\delta =$ 13.2 (q, $\text{CH}_3\text{C}-5$), 13.9 (q, OCH_2CH_3), 30.4 (q, COCH_3), 62.9 (t, OCH_2CH_3), 117.0 (s, C-4), 154.3 (s, C-3), 160.4 (s, CO_2Et), 174.6 (s, C-5), 192.0 (s, COMe) ppm. MS (EI): m/z (%) 197 (100) $[\text{M}]^+$, 182 (62) $[\text{M} - \text{Me}]^+$, 169 (32), 168 (6) $[\text{M} - \text{Et}]^+$, 154 (24), 152 (34), 151 (71), 110 (20), 96 (19), 83 (39), 68 (79). IR (CDCl_3) = nu (tilde) 1739 (C=O), 1685 (C=O),

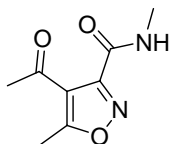
1568, 1308, 1208 cm^{-1} . $\text{C}_9\text{H}_{11}\text{NO}_4$ (197.19): calcd. C 54.82, H 5.62, N 7.10; found C 54.76, H 5.79, N 6.94.

Reaction between acetylacetone (81) and methyl nitroacetate (1j): 4-acetyl-5-methyl-isoxazole-3-carboxylic acid methyl ester (82j)



Treatment of **81** (43 mg) with **1j** (126 mg) by the general procedure gave **82j** (51 mg, 66 %) as a colourless oil after 72 h (CHCl_3) and chromatographic purification (elution with hexane/ AcOEt 5:1; $R_f = 0.16$). ^1H NMR: $\delta = 2.47$ (s, 3 H, COCH_3), 2.64 (s, 3 H, $\text{CH}_3\text{C}-5$), 3.98 (s, 3 H, CO_2CH_3) ppm. ^{13}C NMR: $\delta = 13.2$ (q, $\text{CH}_3\text{C}-5$), 30.4 (q, COCH_3), 53.4 (q, OCH_3), 117.2 (s, C-4), 154.0 (s, C-3), 160.8 (s, CO_2Me), 174.8 (s, C-5), 192.1 (s, COMe) ppm. MS (EI): m/z (%) 183 (34)[M^+], 168 (36) [$\text{M} - \text{Me}^+$], 151 (34), 124 (4), 82 (19), 59 (100) [CO_2Me^+]. IR (CDCl_3) = nu (tilde) 2957, 1744 (C=O), 1686 (C=O), 1628, 1575, 1457, 1310, 1217 cm^{-1} . $\text{C}_8\text{H}_9\text{NO}_4$ (183.16): calcd. C 52.46, H 4.95, N 7.65; found C 52.20, H 4.98, N 7.61.

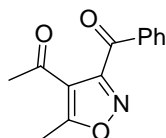
Reaction between acetylacetone (81) and N-methyl nitroacetamide (1g): 4-acetyl-5-methyl-isoxazole-3-carboxylic acid methylamide (82g)



Treatment of **81** (43 mg) with **1g** (125 mg) by the general procedure gave unreacted **81** ($R_f = 0.68$, 6 mg) and **82g** (white solid, $R_f = 0.28$, 27 mg, 35 %) after 38 h (CHCl_3) and chromatographic purification (elution first with hexane and then with hexane / diethyl ether 2 : 5). The yield considering recovered **81** is 41 %. M. p. 108 - 109 $^\circ\text{C}$ (crystallised from isopropyl ether). ^1H NMR: $\delta = 2.56$ (s, 3 H, COCH_3), 2.62 (s, 3 H, $\text{CH}_3\text{C}-5$), 3.00 (d, $J = 4.8$ Hz, 3 H, CONCH_3), 6.85 (br s, 1 H, NH) ppm. ^{13}C NMR: $\delta = 13.3$ (q, $\text{CH}_3\text{C}-5$), 26.4 (q, NCH_3), 31.1 (q, COCH_3),

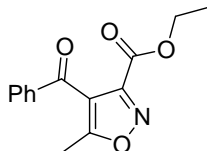
116.8 (s, C-4), 156.1 (s, C-3), 159.6 (s, CONMe), 175.3 (s, C-5), 193.3 (s, COMe) ppm. MS (EI): m/z (%) 182 (14) [M]⁺, 167 (4), 152 (1), 139 (3), 125 (10), 111(5), 83 (8), 58 (100) [CONHMe]⁺. IR (CDCl₃) = nu (tilde) 3438, 1689 (C=O), 1573, 1545, 1457, 1415 cm⁻¹. C₈H₁₀N₂O₃ (182.18): calcd. C 52.74, H 5.53, N 15.38; found C 52.76, H 5.82, N 15.69.

Reaction between acetylacetone (81) and benzoylnitromethane (1a): 4-acetyl-3-benzoyl-5-methylisoxazole (82a)



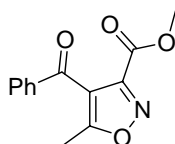
Treatment of **81** (43 mg) with **1a** (175 mg) by the general procedure gave **82a** (62 mg, 64 %) as a colourless oil after 72 h (CHCl₃) and chromatographic purification (elution with hexane/AcOEt 6:1; R_f = 0.31). The same reaction carried out in toluene as above, after column chromatography on silica gel (hexane /diethyl ether/ triethylamine 15 : 1: 1, R_f 0.21), gave the pure compound as yellowish oil (82 mg, 85 %). ¹H NMR: δ = 2.32 (s, 3 H, CH₃CO), 2.75 (s, 3 H, CH₃C-5), 7.48 – 7.53 (m, 2 H, Ph-*H*_{meta}), 7.63 – 7.68 (m, 1 H, Ph-*H*_{para}), 7.99 – 8.03 (m, 2 H, Ph-*H*_{ortho}) ppm. ¹³C NMR: δ = 13.4 (q, CH₃C-5), 30.2 (q, CH₃CO), 117.5 (s, C-4), 128.9 (d, 2 C, Ph-C_{meta}), 130.3 (d, 2 C, Ph-C_{ortho}), 134.8 (d, Ph-C_{para}), 135.6 (s, Ph-C_{ipso}), 159.6 (s, C-3), 174.5 (s, C-5), 187.5 (s, COPh), 191.6 (s, COMe) ppm. MS (EI): m/z (%) 229 (< 1) [M]⁺, 228 (< 1), 199 (14) [M - Me]⁺, 105 (100) [PhCO]⁺, 77 (55) [Ph]⁺, 51 (30). IR (CDCl₃) = nu (tilde) 3069, 1684 (C=O), 1598, 1572, 1457, 1418, 1218 cm⁻¹. C₁₃H₁₁NO₃ (229.23): calcd. C 68.11, H 4.84, N 6.11; found C 67.89, H 5.18, N 6.28.

Reaction between benzoylacetone (83) and ethyl nitroacetate (1b): 4-benzoyl-5-methylisoxazole-3-carboxylic acid ethyl ester (84b)



Treatment of **83** (69 mg) with **1b** (141 mg) by the general procedure gave unreacted **83** ($R_f = 0.50$, 15 mg) and **84b** (colourless oil, $R_f = 0.39$, 71 mg, 65 %) as a colourless oil after 72 h (CHCl_3) and chromatographic purification (elution with hexane/ethyl acetate / Et_3N 10 : 1 : 1). The yield considering recovered **3** is 82 %. $^1\text{H NMR}$: $\delta = 1.03$ (t, $J = 6.8$ Hz, 3 H, OCH_2CH_3), 2.52 (s, 3 H, $\text{CH}_3\text{C-5}$), 4.08 (q, $J = 6.8$ Hz, 2 H, OCH_2CH_3), 7.41 – 7.48 (m, 2 H, Ph- H_{meta}), 7.56 – 7.61 (m, 1 H, Ph- H_{para}), 7.72 – 7.75 (m, 2 H, Ph- H_{ortho}) ppm. $^{13}\text{C NMR}$: $\delta = 12.2$ (q, $\text{CH}_3\text{C-5}$), 13.5 (q, OCH_2CH_3), 62.4 (t, OCH_2CH_3), 116.1 (s, C-4), 128.7 (d, 2 C, Ph- C_{meta}), 128.9 (d, 2 C, Ph- C_{ortho}), 133.6 (d, Ph- C_{para}), 137.7 (s, Ph- C_{ipso}), 155.0 (s, C-3), 159.2 (s, CO_2Et), 173.1 (s, C-5), 188.2 (s, COPh) ppm. MS (EI): m/z (%) 259 (25) $[\text{M}]^+$, 186 (42) $[\text{M} - \text{CO}_2\text{Et}]^+$, 105 (100), $[\text{PhCO}]^+$, 77 (57) $[\text{Ph}]^+$, 51(32). IR (CDCl_3) = nu (tilde) 3067, 2985, 1740 (C=O), 1664 (C=O), 1599, 1449, 1322, 1214 cm^{-1} . $\text{C}_{14}\text{H}_{13}\text{NO}_4$ (259.27): calcd. C 64.86, H 5.05, N 5.40; found C, 64.62, H 5.27, N 5.01.

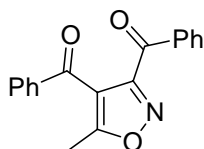
Reaction between benzoylacetone (83) and methyl nitroacetate (1j): 4-benzoyl-5-methylisoxazole-3-carboxylic acid methyl ester (84j)



Treatment of **83** (69 mg) with **1j** (126 mg) by the general procedure gave **84j** (78 mg, 75 %) as a white powder after 72 h (CHCl_3) and chromatographic purification (elution with hexane/diethyl ether / Et_3N 10 : 1 : 1; $R_f = 0.23$). M. p. 86 – 88 °C (reported^[26] 82 – 85 °C, ethanol). $^1\text{H NMR}$: $\delta = 2.52$ (s, 3 H, $\text{CH}_3\text{C-5}$), 3.65 (s, 3 H, OCH_3), 7.43 – 7.50 (m, 2 H, Ph- H_{meta}), 7.56 – 7.62 (m, 1 H, Ph- H_{para}),

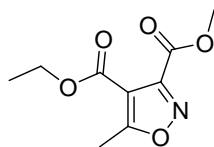
7.70 – 7.76 (m, 2 H, Ph-*H*_{ortho}) ppm. ¹³C NMR: 12.3 (q, CH₃C-5), 52.9 (t, OCH₃), 116.3 (s, C-4), 128.8 (d, 2 C, Ph-C_{meta}), 128.9 (d, 2 C, Ph-C_{ortho}), 133.7 (d, Ph-C_{para}), 137.6 (s, Ph-C_{ipso}), 154.8 (s, C-3), 159.7 (s, CO₂Me), 173.0 (s, C-5), 188.1 (s, COPh) ppm. MS (EI): m/z (%) 245 (16) [M]⁺, 244 (14), 230 (1), 200 (6), 186 (16) [M – CO₂Me]⁺, 105 (62), [PhCO]⁺, 77 (60) [Ph]⁺, 59 (62) [CO₂Me]⁺, 51(34), 43 (100) [COMe]⁺. IR (CDCl₃) = nu (tilde) 3067, 2957, 1745 (C=O), 1664 (C=O), 1600, 1450, 1323, 1221 cm⁻¹. C₁₃H₁₁NO₄ (245.23) calcd. C 63.67, H 4.52, N 5.71; found C 63.86, H 4.78, N 5.62.

**Reaction between benzoylacetone (83) and benzoylnitromethane (1a):
(3-benzoyl-5-methyl-isoxazol-4-yl)-phenyl-methanone (84a)**



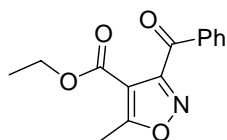
Treatment of **83** (69 mg) with **1a** (175 mg) by the general procedure gave **84a** (113 mg, 93 %) as a colourless oil^[39] after 40 h (toluene) and chromatographic purification (elution with hexane/diethyl ether / Et₃N 10 : 1 : 1; R_f = 0.27). ¹H NMR: δ = 2.56 (s, 3 H, CH₃C-5), 7.31 – 7.37 (m, 2 H, Ph-*H*), 7.41 – 7.47 (m, 2 H, Ph-*H*), 7.47 – 7.53 (m, 1 H, Ph-*H*), 7.57 – 7.63 (m, 1 H, Ph-*H*_{para}), 7.64 – 7.69 (m, 2 H, Ph-*H*_{ortho} on C-4), 7.99 (m, 1 H, Ph-*H*_{ortho} on C-3), 8.01 (m, 1 H, Ph-*H*_{ortho} on C-3) ppm. ¹³C NMR: δ = 12.5 (q, CH₃C-5), 117.1 (s, C-4), 128.6 (d, 4 C, Ph-C), 128.8 (d, 2 C, Ph-C), 130.2 (d, 2 C, Ph-C_{ortho} on C-3), 133.4 (d, Ph-C on C-4), 134.3 (d, Ph-C_{para} on C-3), 135.4 (s, Ph-C), 137.5 (s, Ph-C), 160.7 (s, C-3), 172.4 (s, C-5), 185.4 (s, COC-4), 188.1 (s, COC-3) ppm. MS (EI): m/z (%) 291 (<1) [M]⁺, 105 (100), [PhCO]⁺, 77 (58) [Ph]⁺, 51(30). IR (CDCl₃) = nu (tilde) 3067, 1670(C=O), 1599, 1450, 1323, 1218 cm⁻¹. C₁₈H₁₃NO₃ (291.31): calcd. C 74.22, H 4.50, N 4.81; found C 74.24, H 4.57, N 4.88.

**Reaction between ethyl acetoacetate (85) and methyl nitroacetate (1j):
5-methyl-isoxazole-3,4-dicarboxylic acid 4-ethyl ester 3-methyl ester (86j)**



Treatment of **85** (55 mg) with **1j** (126 mg) by the general procedure gave **86j** (26 mg, 29 %) as a colourless oil after 72 h (CHCl₃) and chromatographic purification (elution with hexane/diethyl ether 5 : 1; R_f = 0.22). ¹H NMR: δ = 1.31 (t, *J* = 7.2 Hz, 3 H, CH₂CH₃), 2.67 (s, 3 H, CH₃C-5), 3.95 (s, 3 H, OCH₃), 4.28 (q, *J* = 7.2 Hz, 2 H, CH₂CH₃) ppm. ¹³C NMR: δ = 12.7 (q, CH₃C-5), 14.0 (t, CH₃CH₂), 53.2 (q, OCH₃), 61.3 (t, CH₃CH₂), 108.7 (s, C-4), 155.4 (s, C-3), 160.4 (s, CO₂Me), 160.5 (s, CO₂Et), 175.2 (s, C-5) ppm. IR (CDCl₃) = nu (tilde) 2957, 1723 (C=O), 1750(C=O), 1607, 1431 cm⁻¹. MS (EI): *m/z* (%) 213 (2) [M]⁺, 198 (1) [M - Me]⁺, 182 (2) [M - OMe]⁺, 168 (8), 167 (8), 82 (22), 59(75) [CO₂Me]⁺, 43(100). IR (CDCl₃) = nu (tilde), 2950, 1750 (C=O), 1723 (C=O), 1607, 1457 cm⁻¹. C₉H₁₁NO₅ (213.19): calcd. C 50.70, H 5.20, N 6.57; found C 50.84, H 4.98, N 6.32.

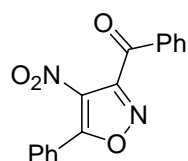
Reaction between ethyl acetoacetate (85) and benzoyl-nitromethane (1a): 3-benzoyl-5-methyl-isoxazole-4-carboxylic acid ethyl ester (86a)



Treatment of **85** (55 mg) with **1a** (175 mg) by the general procedure gave **86a** (11 mg, 10 %) as a colourless oil after 72 h (toluene) and chromatographic purification (elution with hexane/diethyl ether/ triethylamine 15:1:1; R_f = 0.21). The same reaction carried out as above, but with added pyrrolidine (15 mg, 0.214 mmol) gave **86a** as a yellowish oil (28 mg, 25 %). ¹H NMR: δ = 1.00 (t, *J* = 7.2 Hz, 3 H, CH₂CH₃), 2.75 (s, 3 H, CH₃C-5), 4.09 (q, *J* = 7.2 Hz, 2 H, CH₂CH₃), 7.45 - 7.50 (m, 2 H, Ph-*H*_{meta}), 7.59 - 7.64 (m, 1 H, Ph-*H*_{para}), 7.87 - 7.92 (m, 2 H, Ph-*H*_{ortho}) ppm. ¹³C NMR: δ = 12.8 (q, CH₃C-5), 13.6 (t, CH₃CH₂), 61.1 (t,

CH₃CH₂), 109.2 (s, C-4), 128.7(d, 2 C, Ph-C_{meta}), 129.8 (d, 2 C, Ph-C_{ortho}), 134.4 (d, Ph-C_{para}), 135.7(s, Ph-C_{ipso}) 160.4 (s, CO₂Et or C-3), 160.6 (s, CO₂Et or C-3), 175.2 (s, C-5), 186.8 (s, PhCO) ppm. GC MS (CI): m/z (%) 260 (<1) [M + H]⁺, 105 (100) [PhCO]⁺, 77 (19) [Ph]⁺, 51(14). IR (CDCl₃) = nu (tilde) 3068, 2964, 1724 (C=O), 1682, 1449 (C=O), 1599 cm⁻¹. C₁₄H₁₃NO₄ (259.26): calcd. C 64.86, H 5.05, N 5.40; found C 65.12, H 5.38, N 5.48.

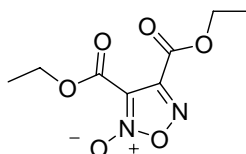
Benzoylnitromethane self-condensation: 3-benzoyl-4-nitro-5-phenylisoxazole (88)



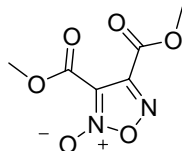
Copper (II) acetate (7.8 mg, 0.0414 mmol) was added to a mixture of benzoylnitromethane (**1a**) (175 mg, 1.06 mmol) and DABCO (**3**) (9.6 mg, 0.0848 mmol) in chloroform or toluene (1.4 mL) and the mixture magnetically stirred in a sealed vessel at 60 °C. After 18 h the reaction mixture was concentrated and the residue was purified by chromatography on silica gel eluting first with hexane/ diethyl ether / triethylamine 15 : 1 : 1 to afford benzoylnitromethane (**1a**) (R_f = 0.50, 16 mg, 0.097mmol), **88** (R_f = 0.21, 46 mg, 29 %) and then with hexane/ diethyl ether / triethylamine / MeOH 15 : 1 : 1 : 1 to afford triethylammonium benzoate (119 mg, 0.721mmol). **88**. M. p. 100 - 101 °C, (reported^[40] 100 - 101 °C, from methanol). ¹H NMR: δ = 7.52 - 7.62 (m, 4 H, Ph-H_{meta}), 7.64 - 7.72 (m, 2 H, Ph-H_{para}), 7.98 - 8.02 (m, 2 H, Ph-H_{ortho} on C-5), 8.02 - 8.06 (m, 2 H, Ph-H_{ortho} on C-3) ppm. ¹³C NMR: δ = 123.7 (s), 129.0 (d, 2 C, Ph-C_{meta}), 129.1 (d, 2 C, Ph-C_{meta}), 129.4 (d, 2 C, Ph-C_{ortho} on C-5), 130.1 (d, 2 C, C(O)-Ph-C_{ortho}), 133.4 (d, Ph-C_{para} on C-5), 134.8 (s), 135.2 (d, C(O)Ph-C_{para}), 156.9 (s, C-3), 167.9 (s, C-5), 183.5 (s, COPh) ppm. One carbon atom was not detected. MS (EI): m/z (%)^[41] 147 (10) [PhC(O)C≡N-O]⁺, 131 (34) [PhC(O)C≡N]⁺, 105 (100) [PhCO]⁺, 77 (80) [Ph]⁺, 51 (38). IR (CDCl₃) = nu(tilde) 3069, 1687 (C=O), 1600, 1575, 1527, 1468, 1360, 1265, 1233 cm⁻¹. C₁₆H₁₀N₂O₄ (294.26): calcd. C 65.31, H

3.43, N 9.52; found C 65.04, H 3.76, N 9.63. **Triethylammonium benzoate**. ^1H NMR (200 MHz): δ = 1.29 (t, J = 6.0 Hz, 3 H, CH_3CH_2), 3.14 (q, J = 6.0 Hz, 3 H, CH_3CH_2), 6.77 (s, br, 1 H, NH), 7.42 - 7.52 (m, 3 H, Ph-H), 7.85 - 8.20 (m, 2 H, Ph-H) ppm.

Ethyl nitroacetate (1b) self-condensation: diethyl 1,2,5-oxadiazole-3,4-dicarboxylate 2-oxide (87b)



Copper (II) acetate (22 mg, 0.12 mmol) was added to a mixture of ethyl nitroacetate (**1b**) (399 mg, 3.0 mmol) and 1-methylpiperidine (**3c**) (24 mg, 0.24 mmol) in chloroform (2 mL) and the mixture magnetically stirred in a sealed vessel at 60 °C. After 96 h the reaction mixture was diluted in chloroform (25 mL) and washed with H_2O (2×20 mL), 0.05 N NaOH (3×20 mL) and H_2O (3×20 mL). The organic layer was dried over Na_2SO_4 and filtered. The chloroform was removed under vacuum to give the furoxan **87b** as a pale yellow oil (0.15 g, 43 % yield). An analytical sample was obtained using a sublimator at 0.4 mmHg and 60 °C as a colourless oil. ^1H NMR: δ = 1.36 (t, J = 7.2 Hz, 3 H, $\text{CO}_2\text{CH}_2\text{CH}_3$), 1.40 (t, J = 6.8 Hz, 2 H, $\text{CO}_2\text{CH}_2\text{CH}_3$), 4.42 (q, J = 6.8 Hz, 2 H, $\text{CO}_2\text{CH}_2\text{CH}_3$), 4.47 (q, J = 7.2 Hz, 2 H, $\text{CO}_2\text{CH}_2\text{CH}_3$) ppm. ^{13}C NMR: δ = 13.8 (q, CH_3), 13.9 (q, CH_3), 63.1 (t, 2 C, $2 \times \text{COCH}_2$), 106.7 (s, C-3), 148.3 (s, C-4), 155.1 (s, CO_2Et), 156.6 (s, CO_2Et) ppm. MS (EI): m/z (%) 231 (9) $[\text{M}+1]^+$, 230 (4) $[\text{M}]^+$, (200 (9), 185 (73), 169 (20), 168 (18), 159 (19), 158 (100), 157 (28), 141 (25), 130 (96), 111 (18), 100 (32). IR (film) = ν (tilde) 2987, 1748 (C=O), 1626, 1480, 1374, 1333, 1246 cm^{-1} .

Methyl nitroacetate (1j) self-condensation: dimethyl 1,2,5-oxadiazole-3,4-dicarboxylate 2-oxide (87j)

Methyl nitroacetate (**1j**) (126 mg, 1.062 mmol) was added to a mixture of copper (II) acetate (3.9 mg, 0.0212 mmol) and 1-methylpiperidine (8.4 mg, 0.0849 mmol) in chloroform (1.4 mL) and the mixture magnetically stirred in a sealed vessel at 60 ° C. After 96 h the reaction mixture was concentrated and the residue purified by chromatography on silica gel with hexane/ethyl acetate 8 : 1 ($R_f = 0.19$) to afford the furoxan **87j** as a colourless oil (73 mg, 68 %). $^1\text{H NMR}$: $\delta = 3.97$ (s, 3 H, CO_2CH_3), 4.02 (s, 3 H, CO_2CH_3) ppm. $^{13}\text{C NMR}$: $\delta = 53.9$ (q, 2 C, $2 \times \text{CO}_2\text{CH}_3$), 106.6 (s, C-3), 148.0 (s, C-4), 155.0 (s, CO_2Me), 157.0 (s, CO_2Me) ppm. MS (EI): m/z (%) 202 (1) $[\text{M}]^+$, 172 (8), 171 (6) $[\text{M} - \text{OMe}]^+$, 128 (11), 111 (12), 100 (6), 98 (12), 59 (100) $[\text{CO}_2\text{Me}]^+$. IR (film) = ν (tilde) 2958, 1752 (C=O), 1628, 1483, 1342, 1312, 1252 cm^{-1} .

Crystallisation and X-ray structural-analysis of compound 88

A suitable crystal for X-ray diffraction analysis of isoxazole (**88**) was obtained by recrystallisation from methanol / diethyl ether 3 : 1.

X-ray analysis was carried out with a Siemens P4 diffractometer at room temperature. Graphite-monochromated $\text{Mo}/\text{K}\alpha$ radiation. The integrated intensities, measured using the ω scan mode, were corrected for Lorentz and polarization effects.¹⁵⁷ The structure was solved by direct methods of SIR97¹⁵⁸ and refined using the full-matrix least squares on F^2 provided by SHELXL97.¹⁵⁹

¹⁵⁷ N. Walker, D. Stuart, *Acta Crystallogr., Sect. A* **1983**, 39, 158-166.

¹⁵⁸ A. Altomare, M. C. Burla, M. Camalli, G. L. Cascarano, C. Giacovazzo, A. Guagliardi, A. G. G. Moliterni, G. Polidori, R. Spagna, *J. Appl. Crystallogr.* **1999**, 32, 115-119.

¹⁵⁹ G. M. Sheldrick, *SHELXL97: A Program for Crystal Structure Refinement*, University of Göttingen, Göttingen, Germany, **1997**.

The non-hydrogen atoms were refined anisotropically whereas hydrogen atoms were assigned in calculated positions and refined as isotropic.

$C_{16}H_{10}N_2O_4$, $M = 294.26$ Monoclinic, space group $P2_1/n$, $a = 5.7370(10)$, $b = 12.1950(10)$, $c = 19.844(3)$ Å, $\beta = 95.940(10)$, $V = 1380.9(3)$ Å³, $Z = 4$, $D_c = 1.415$, $\mu = 0.104$ mm⁻¹, $F(000) = 608$. 12191 reflections were collected with a $1.96 \leq \theta \leq 25.0$ range; 2414 were independent, the number of parameters were 239 and the final R index was 0.0399 for reflections having $I \geq 2\sigma I$.

CCDC-721723 contains the supplementary crystallographic data for this paper. These data can be obtained free of charge from The Cambridge Crystallographic Data Centre via www.ccdc.cam.ac.uk/data_request/cif.

Chapter 6

6. “In Water” and “On Water” Condensations

6.1. Introduction

Water is a desirable solvent for chemical reactions for reasons of cost, safety, and environmental concerns, and the study of organic reactions in aqueous solvents has an intriguing history.¹⁶⁰ Water exhibits special properties as compared to commonly employed organic solvents.¹⁶¹ For instance, Breslow and co-workers reported acceleration of the Diels-Alder reaction “in water” with the reaction performed at very high dilution to dissolve the reactants,¹⁶² while Sharpless and co-workers

¹⁶⁰ a) *Organic Synthesis in Water* (Ed.: P.A. Grieco), Blackie, London, **1998**; b) C. -J. Li *Chem. Rev.* **1993**, 93, 2023; c) U. M. Lindstrom *Chem. Rev.* **2002**, 102, 2751.

¹⁶¹ F. Fringuelli, O. Piermatti, F. Pizzo, L. Vaccaro *Eur. J. Org. Chem.* **2001**, 439-455.

¹⁶² a) R. Breslow, D. Rideout *J. Am. Chem. Soc.* **1980**, 102, 7816-7817; b) R. Breslow *Acc. Chem. Res.* **1991**, 24, 159-164.

described "on water" conditions under which substantial rate acceleration was observed when the organic reactants were insoluble in the aqueous phase.¹⁶³ In addition to a rate acceleration and higher selectivity hydrophobic effects were observed; it has since been appreciated that hydrogen bonding plays an important role.¹⁶⁴ Like Diels–Alder reactions, 1,3-dipolar cycloadditions are concerted and nearly synchronous processes with little change in polarity during the reaction. Because of these similarities one would expect that also 1,3-dipolar cycloadditions can benefit from hydrophobic interactions. Depending on the nature of the 1,3-dipole, hydrogen bonding can in some cases result in stabilisation of the FMOs of this species, increasing the HOMO–LUMO gap and thereby reducing the rate of the reaction.¹⁶⁵ Although the kinetics of 1,3-dipolar cycloadditions has already been studied in 1978,¹⁶⁶ it took until 1991 before the unusual influence of water on this reaction was first noticed.¹⁶⁷

6.2. Results and discussion

It was demonstrated that the catalytic method for the cycloaddition-condensation of primary nitro compounds with dipolarophiles to isoxazole derivatives needs no dehydrating agents, but takes place even in the presence of water.

Preliminary experiments gave encouraging results with different substrates (Table 6-1).

¹⁶³ Narayan, S.; Muldoon, J.; Finn, M. G.; Fokin, V. V.; Kolb, H. C.; Sharpless, K. B. *Angew. Chem.*, **2005**, *117*, 3339; *Angew. Chem., Int. Ed.* **2005**, *44*, 3275–3279.

¹⁶⁴ S. Otto, J.B.F.N. Engberts, *Org. Biomol. Chem.* **2003**, *1*, 2809.

¹⁶⁵ D. van Mersbergen, J. W. Wijnen and J. B. F. N. Engberts, *J. Org. Chem.*, **1998**, *63*, 8801.

¹⁶⁶ K. J. Dignam, A. F. Hegarty and P. L. Quain, *J. Org. Chem.*, **1978**, *43*, 388.

¹⁶⁷ Y. Inoue, K. Araki and S. Shiraishi, *Bull. Chem. Soc. Jpn.*, **1991**, *64*, 3079.

Table 6-1. Condensation of different nitro compounds and dipolarophiles under base/copper catalysis.

$\text{R-CH}_2\text{-NO}_2 + \text{Dipolarophile} \xrightarrow[\text{H}_2\text{O, 60 }^\circ\text{C}]{\text{Base, Cu(0)}}$

1a-b, 1d, 1g, 1i, 72, 90-91 **2a-d, 36j**

Entry	R	Dipolaroph.	Base (equiv.)	t (h)	Prod.	Conv. %	Yield [a]
1	CO ₂ Et		NMP (0.2)	18	24	100	100
2	CONH(Me)Bn		NMP (0.2)	144	49	n.d.	85
3	CONHMe		NMP (0.2)	18	92	100	94
4	PhCO		NMP (0.2)	18	93	- [b]	-
5	CH ₂ OH		NMP (0.5-0.2)	18	94	n.d.	-
6	CH ₃		NMP (0.5)	18	95	- [b]	-
7	(CH ₂) ₃ CH ₃		NMP (0.5)	72	66	0	-
8			NMP (0.2)	16	17	100	52 [c]
9	CO ₂ Et		NMP (0.2)	16	10	100	89 [b]
10			NMP (0.2)	16	38j	n.d.	31 [b]
11	SO ₂ Ph		NMP (0.2)	16	7	0	-
12			NMP (0.2)	16	96	0	-

[a] Spectroscopic (¹H NMR) yield with internal standard [2,4-dimethoxyacetophenone (**97**) or dimethyl sulfone (**42**)]; [b] In these conditions the nitro compounds decompose; [c] The yield is after work-up.

Nitroacetic esters (**1b**) or amides (**1g** and **72**) appear suited for this procedure (entries 1-3 and 8-10). Other nitro compounds are unreactive, like nitropentane (**1i**) (entry 7), or decompose, like benzylnitromethane

(1a) (entry 4) and nitroethane (91) (entry 6). It is worth to notice the behaviour of nitroethanol (90), that is unreactive in CHCl_3 , but in water leads to an unidentified product.

As it was shown in the introduction of this chapter, water accelerates some reactions: the authors mentioned above, define a reaction "in water" as one in which the reactants participating in the reaction are dissolved homogeneously in water, whereas a reaction "on water" occurs when part of the organic reactants are insoluble in the aqueous phase. Another definition was given for a reaction "in the presence of water", that should be used for a reaction that proceeds in a concentrated organic phase with water being present as a second phase that affects the reaction occurring in the organic phase. In order to understand if the reaction rate increases "in the presence of water", the reaction between ethyl nitroacetate (1b) and styrene (2b) was carried out with increasing amounts of water, and the results are shown in Table 6-2.

Table 6-2. Condensation of ethyl nitroacetate (1b) and styrene (2b) with different amounts of water under base/copper catalysis.

Reaction scheme: Ethyl nitroacetate (1b) + Styrene (2b) $\xrightarrow[\text{Medium, 60 } ^\circ\text{C, 17 h}]{\text{DABCO, Cu(AcO)}_2}$ Product 10

Entry	Medium	Conv. % ^[a]
1	CHCl_3	55
2	CHCl_3 - H_2O saturated	66
3	$\text{CHCl}_3/\text{H}_2\text{O}$ (100eq)	0
4	H_2O	89

[a] Conversion evaluated by ^1H NMR with internal standard [2,4-dimethoxyacetophenone (97) or dimethyl sulfone (42)].

The reaction is slightly faster with the saturated organic solvent and faster in the sole water, but no product is observed using the biphasic system; probably in this last condition the reactive species were not in contact.

6.2.1. The sole base catalysis

It was demonstrated that ethyl nitroacetate (**1b**) reacts in the presence of the sole base, as well.⁴ These reactions are in general carried out in chloroform solution at 60°C with the reagents ethyl nitroacetate (**1b**), dipolarophile and base (usually DABCO, **3**), in the 2.5 : 1 : 0.1 molar ratios, respectively. A long induction period has been evidenced and ascribed to a slow pre-equilibrium of reversible cycloaddition of nitronate to dipolarophile: the cycloadduct then undergoes irreversible loss of water to give the product. The same reagents, when treated with water instead of chloroform, give the same products in a much shorter time, even though the reagents have in general only partial solubility in water (if any), (Table 6-3). An increase of the rate of cycloaddition reactions in water is well documented: examples are reported for reactions “in water” (single phase)^{162,168} and “on water” (if some reagents are out of the aqueous phase).^{162, 163}

¹⁶⁸ R. N. Butler, W. J. Cunningham, A. G. Coyne, L. A. Burke *J. Am. Chem.Soc.* **2004**, *126*, 11923-11929.

Table 6-3. Condensation of ethyl nitroacetate with different dipolarophiles under base catalysis. Comparison between water and chloroform.

Entry	Dipolarophile	Prod.	H ₂ O	CHCl ₃
			% ^[b]	% ^{[b], [d]}
1		24	83	0(16)
2			49 ^[a]	
3		26	88	0(57)
4		10	52(64) ^[c]	0(25)
5		5	63(95) ^[c]	0(96)
6		29	96	0(91)
7		17	69	4(74)
8		34	61	2(65)
9		96	40	0(84)
10		98	65(84) ^[d]	0(61)

[a] Neat. [b] Spectroscopic yield evaluated by ¹H NMR after 18 h. [c] In parentheses the spectroscopic yield after 66 h. [d] In parentheses the spectroscopic yield after 80 h.

The data in Table 6-3 refer to the following reaction conditions: ethyl nitroacetate (**1b**) (1.06 mmol) + dipolarophile (0.424 mmol) + DABCO (**3**) (0.0424 mmol) in 1.4 mL of solvent: the solubility is complete in chloroform, but partial in water. In fact, a saturated solution of ethyl

nitroacetate (**1b**) in water is about 0.17 M at r.t. If a base (DABCO (**3**), 0.03 M) is added, the produced salt increases up to 0.20 M the overall concentration of nitroacetate and its salt (nitronate). These values are not significantly modified at 60°C. Therefore, in our reaction conditions, the excess of nitroacetate gives rise to an organic layer and the reaction takes place partly in water and partly in the organic phase.

The reaction progress has been followed by plotting *vs* time the conversion of the dipolarophile into product for two model condensations of ethyl nitroacetate (**1b**): with a water soluble dipolarophile (allyl alcohol (**2d**), solubility > 0.3 M) and with a water insoluble dipolarophile (styrene, **2b**), (see Table 6-3 entries 1 and 3, respectively).

The reactions in chloroform solution and with water are compared, though in water the reaction occurs in heterogeneous system, as noticed above. The graphs in Figure 6-1 refer to the reaction with allyl alcohol (**2d**) and show that in chloroform (white stars) a 14% conversion, attained after 44 h, is preceded by a very long induction period (23 hours). During this time nitroacetate undergoes in part hydrolytic cleavage to ethanol, carbon dioxide and nitromethane. The conversion in the presence of water could not be monitored directly and has been evaluated by concentrating each sample at the time indicated (solid circles), or extracting with CDCl₃ (solid circles), then recording the spectrum of the residue after dissolution in deuteriochloroform. The dramatic drop of the induction period with enhanced rate observed for the overall conversion is ascribed in part to the neat reaction (solid triangles) but mainly to the reaction occurring "in water".

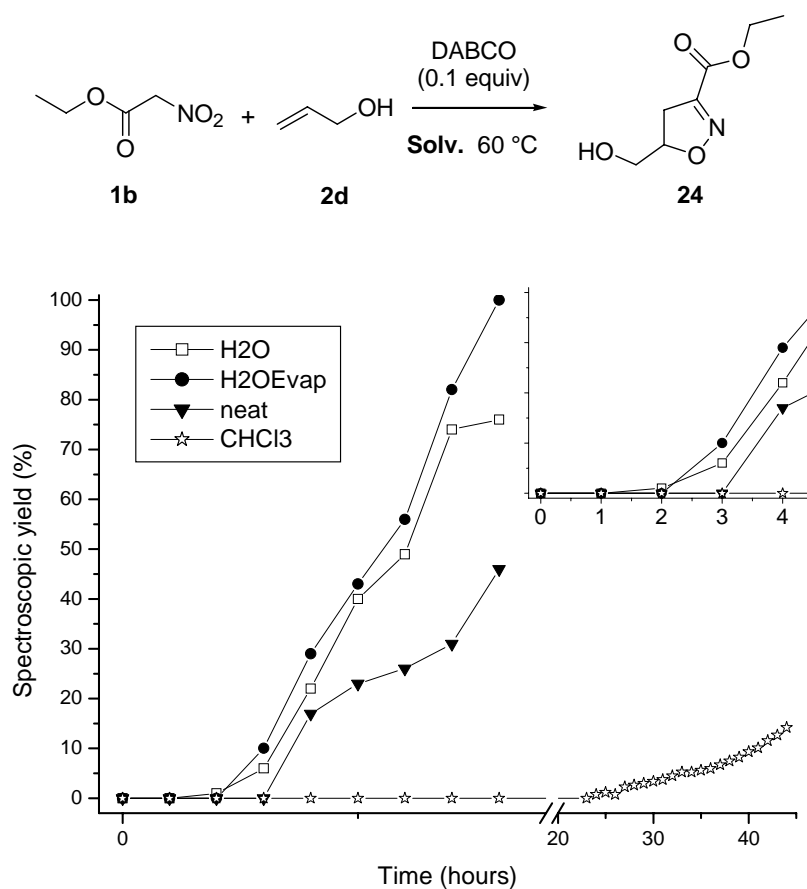


Figure 6-1. The kinetic profiles are carried out in CHCl₃ (white stars), in water (white squares, where the products were extracted; solid cycles, where the solvent was removed in vacuum) and neat (solid triangles).

In Figure 6-2 similarly illustrates the progress of the reaction with styrene (2b).

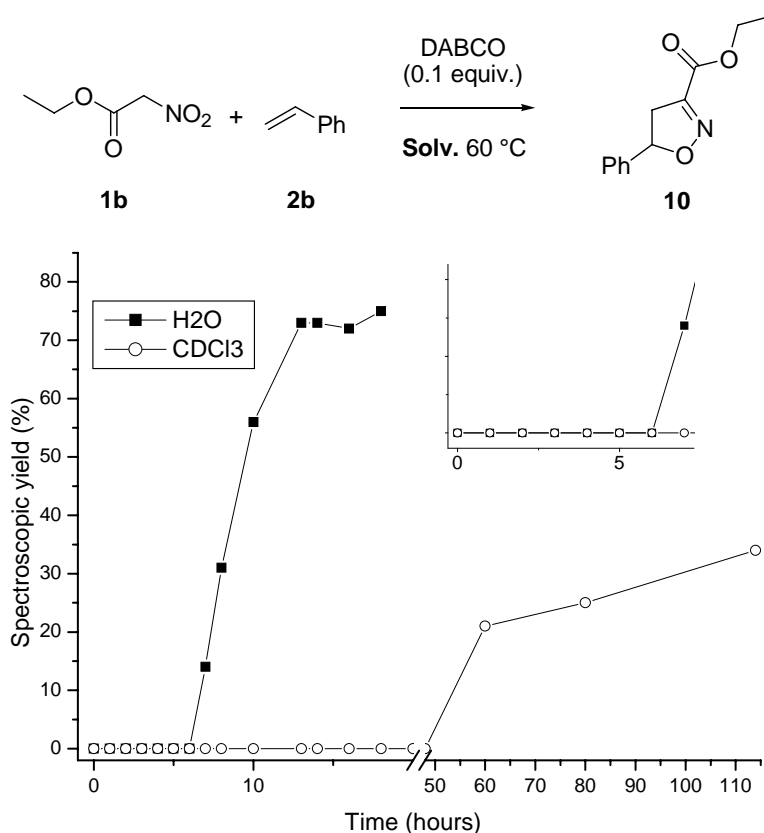
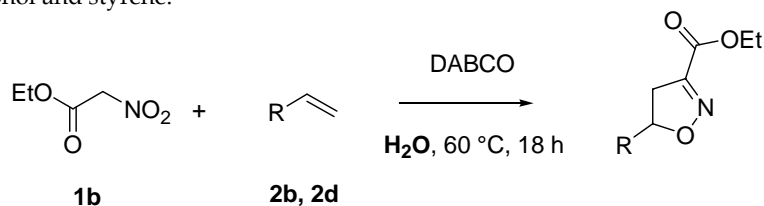


Figure 6-2. The kinetic profiles are carried out in CHCl₃ (white cycles) and in water (solid squares, where the products were extracted).

The reaction with styrene (**2b**), owing to its insolubility, is assumed to take place mainly “on water”, and the reaction with allyl alcohol (**2d**) “in water”. Indeed, comparing the stirred and unstirred reactions in the presence of water and base indicated in Table 6-4, these conclusions can be drawn:

- 1) Since stirring does not significantly modify the reaction rate, we consider the reaction with allyl alcohol (**2d**) to take place “in water”;
- 2) On the contrary, stirring is essential for the reaction with styrene (**2b**) to occur, therefore we consider this reaction to take place “on water”.

Table 6-4. Stirred and unstirred reactions between ethyl nitroacetate and allyl alcohol and styrene.

Entry	R	Stirred	Prod.	Yield [a]
1		yes		76
2	CH ₂ OH	no	24	74
3		yes		73
4	Ph	no	10	25

[a] Spectroscopic yield evaluated by ¹H NMR after 18 h.

6.2.2. The role of the Base

The observed reactivity enhancement caused by the presence of water (either "in water" and "on water") prompted to consider also the effect of base variation. The model reactions with allyl alcohol (**2d**) and with styrene (**2b**), carried out in various experimental conditions, gave the results reported in Table 6-5.

Without base, no reaction is observed in the "neat" mixture of nitroacetate with styrene (**2b**) (entry 1), while a low but significant conversion (entry 1) is found in the "neat" mixture with allyl alcohol (**2d**): the hydroxy group might provide a small catalytic effect. On addition of water, both reactions are faster even at lower temperature (entries 2).

Table 6-5 show almost the same result if either tertiary, or secondary, or primary amines, or sodium hydroxyde are used at the same concentration (0.1 eq., entries 5, 7-11, Table 6-5). The reactivity of dipolarophiles with ethyl nitroacetate (**1b**) depends on the amount of added base (pH is less significant, as the excess of nitroacetate as a separate phase buffers the aqueous solution). The conversion of both reactions observed after 18 h, plotted *vs* the equivalents of sodium hydroxyde (Figure 6-3), shows a maximum conversion at 0.1 eq. of base employed. The reactions with 1 or 2.5 eq. of sodium hydroxyde failed due to the lack or drop of acidity necessary for water release and also to a rapid cleavage of nitroacetate in these conditions.

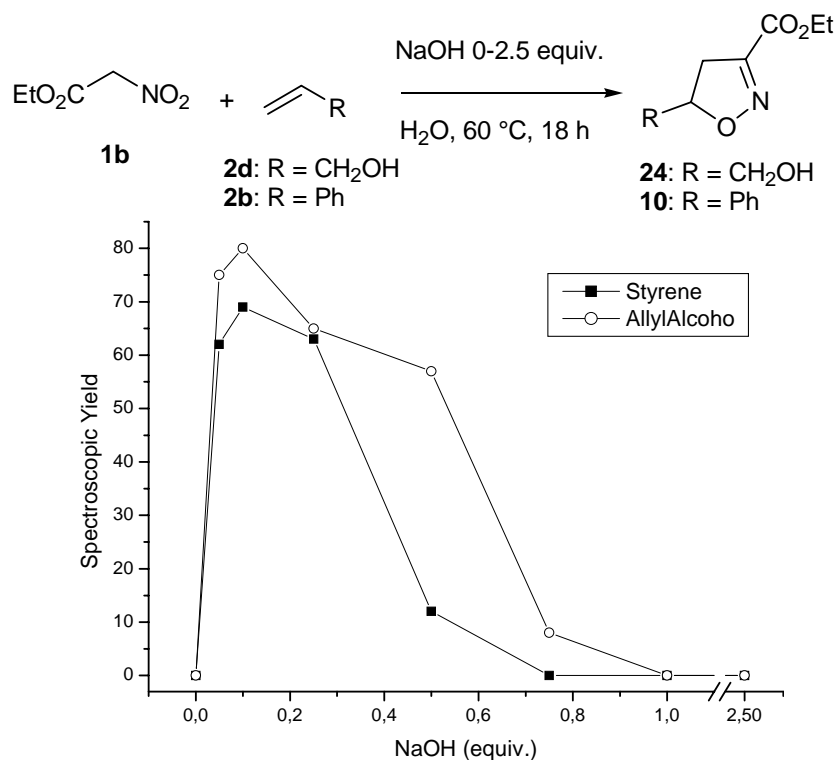


Figure 6-3. Conversion observed after 18 h *vs* the equivalents of sodium hydroxyde used, in the reaction between ethyl nitroacetate (**1b**) and allyl alcohol (**2d**, white cycles) or styrene (**2b**, solid squares).

6.2.3. Effect of water on enantioselectivity

As it was shown in Chapter 4 different conditions were used to improve reaction selectivity: several nitro compounds (ester, amide, ketone), dipolarophiles, bases, ligands and different temperatures were employed. Further variation in the reaction conditions could be the use of water as solvent; the results are illustrated in Table 6-6.

Table 6-6. Reactions in water as solvent.

$$\text{R-CH}_2\text{-NO}_2 + \text{CH}_2\text{=CH-CH}_2\text{-OH} \xrightarrow[\text{Base [Cu] wire}]{\text{H}_2\text{O 60 }^\circ\text{C}} \text{Product (24, 49)}$$

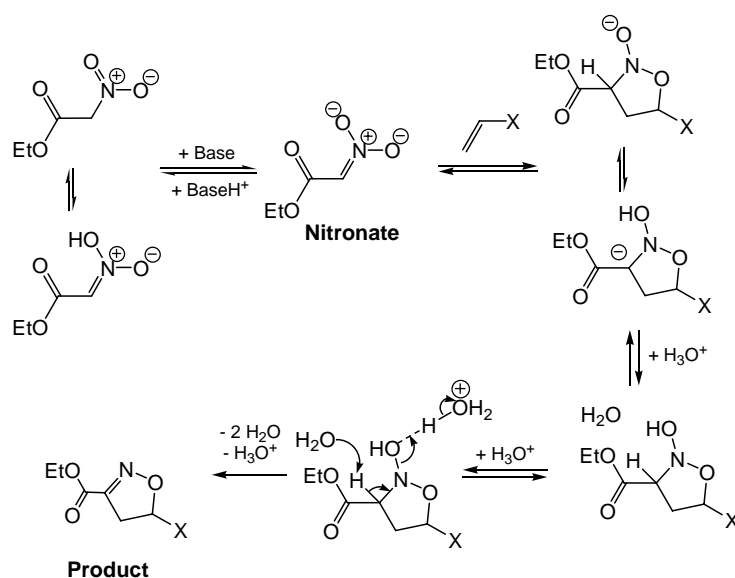
Entry	R	Base (equiv)	[Cu] (equiv.)	t (h)	Conv. [a]	er %/ ee% [b]
1	CO ₂ Et	(-) cinconidin (0.1)	Cu wire	18	100	50.8:49.2 1.6
2	CONH(Me)CHPh	NMP (0.2)	Cu wire	192	54	- [c]
3 ^[d]		(-) cinconidin (0.1)	Cu(0) (0.05)	22	70	51.6:48.4 3.2
4 ^[d]	CO ₂ Et	(-) cinconidin (0.1)	Cu(AcO) ₂ (0.05)	72	70	48.3:51.7 3.4
5 ^[d]		(-) cinconidin (0.1)	Cu(AcO) ₂ (1)	96	0	-
6 ^[d]		(-) cinconidin (0.1)	Cu wire	72	69	46.6:53.4 6.8

[a] Conversion evaluated by NMR [b] enantiomeric excess is based on gas-chromatographic analysis; [c] the peaks were not resolved; [d] These reaction were carried out with 1 equiv. of nitro compound and 2.5 equiv. of dipolarophile.

In these conditions, as in reactions with CHCl_3 as solvent, a low enantiomeric excess was observed (compare with entry 3, Table 4-11 in Chapter 4); in conclusion, regardless of the solvent, the enantiomeric excess increases if an excess of dipolarophile is used (Table 6-6, entries 3-6).

6.3. Conclusions

In conclusion, a catalytic amount of base is required for the condensation to take place: this means that the nitronic acid tautomer of the nitro compound does not react with the dipolarophile, but the nitronate does (Scheme 6-1). However, the success of the reaction rests on the excess of nitroacetate that keeps the pH of the medium low enough to allow the water release in the final irreversible r.d. step.



Scheme 6-1.

If the molar fraction distributions of ethyl nitroacetate (**1b**) and nitronate *versus* pH (Figure 6-4) are considered, at a pH between 5 and 7 the two species are present, and this represent the right condition to carry out the reactions.

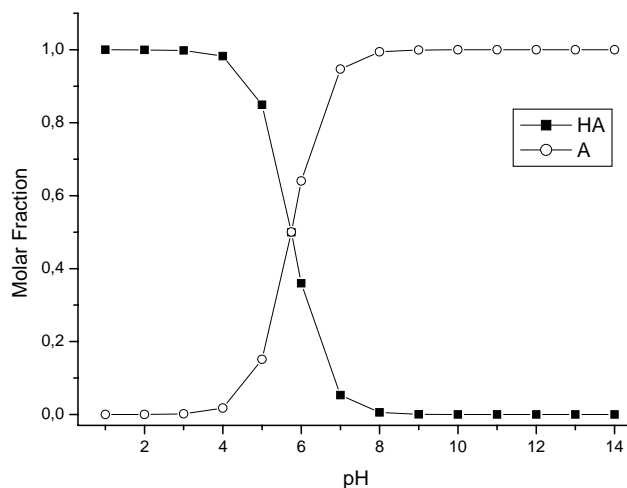


Figure 6-4. Molar fractions distribution *versus* pH of ethyl nitroacetate (**1b**) (solid squares) and ethyl nitronate (white cycles).

6.4. Experimental Section

General methods: for the instruments used and other details see Experimental Section in Chapter 2. GC spectra were obtained as illustrated in Chapter 4.

All compounds were named with Autonom[®] (Beilstein Information Systems) and modified where appropriate.

Materials: Commercially available (Lancaster and Aldrich) nitro compounds, organic bases and olefins were used as supplied. *N*-phenylethyl-2-nitroacetamide (**72**) was prepared according to reported procedure (Chapter 4).

The spectral data for the products **5**, **24**, **26**, **29** and **34** are identical to those reported in Chapter 2 and for the products **38j** and **49** in Chapter 3 and 4 respectively. Products **10** and **17** have been already characterised and previously reported.³

Reaction conditions affecting condensation of ethyl nitroacetate (1b) with allylic alcohol (2d) or styrene (2b) in neat and water media (Table 6-5)

The conversions and spectroscopic yields reported in Table 6-5 refer to reactions performed in an apparatus where eight reactions were carried out simultaneously. *Entries 4-11:* A mixture of ethyl nitroacetate (**1b**) (1.06 mmol), allylic alcohol (**2d**) or styrene (**2b**) (0.424 mmol), base (0.0424 mmol) and water (1.4 mL) was kept at 30 °C or 60 °C. After the indicated time, the reaction mixture was extracted with CDCl₃ (3x0.6 mL) and 2,4-dimethoxy-acetophenone (**97**) (14 - 21 mg, 0.078-0.12 mmol) was added as internal standard and the ¹H NMR spectrum registered. Integration of the 3' and 5'-proton signals of the internal standard (m, 6.40-6.58), the signals of the H-4 (m, 3.05-3.28 ppm, 2H or dd, 3.20 ppm, 1H) protons of compound **24** or **10** respectively gave the spectroscopic yield. *Entry 1:* A mixture of ethyl nitroacetate (**1b**) (1.06 mmol), allylic alcohol (**2d**) or styrene (**2b**) (0.424 mmol), was kept at 60 °C then as above. *Entries 2-3 12-14:* A mixture of ethyl nitroacetate (**1b**) (1.06 mmol), allylic alcohol (**2d**) or styrene (**2b**) (0.424 mmol), in water or the indicated buffer (1.4 mL) was kept at 60 °C then as above. In case of an unclear result, a duplicate experiment was run.

Determination of kinetic profile for the reactions between ethyl nitroacetate (1b) and allyl alcohol (2d) or styrene (2b). (Figure 6-1 and Figure 6-2)

Reactions in CDCl₃ were run in a septum-sealed 5mm NMR tube spinning (20 Hz) in the probe of the spectrometer at 60 °C.

CDCl₃: *Preparation of samples.* Mother reaction mixtures were prepared by dissolving DABCO (**3**) (4.8 mg, 0.0425 mmol), ethyl nitroacetate (**1b**) (141 mg, 1.062 mmol), allyl alcohol (**2d**) (24 mg, 0.425 mmol) or styrene (**2b**) (44 mg, 0.425 mmol) and the internal standard (CH₃)₂SO₂ (**42**) (11-15 mg, 0.1169-0.1594 mmol)

in CDCl₃ (1.4 mL, freshly filtered through K₂CO₃). A sample reaction was obtained after transfer of 560 μL of the above solutions in a septum-sealed NMR tube. In case of unclear result a duplicate reaction was run.

Spectroscopic yield evaluation. An array of ¹H NMR spectra, recorded at intervals of 30 or 60 minutes, was collected for every run and the concentrations were evaluated by integrating the CH₃ protons signals (2.89 ppm) of the internal standard and the H-4 protons signals for **24** and **10** (m, 3.05-3.28 ppm, 2H or dd, 3.20 ppm, 1H).

H₂O: *Preparation of samples.* Reaction mixtures were prepared by mixing DABCO (**3**) (4.8 mg, 0.0425 mmol), ethyl nitroacetate (**1b**) (141 mg, 1.062 mmol), allyl alcohol (**2d**) (24 mg, 0.425 mmol) or styrene (**2b**) (44 mg, 0.425 mmol) in H₂O (1.4 mL) and the reaction was kept at 60 °C.

Spectroscopic yield evaluation. Every hour, the reaction mixture was extracted with CDCl₃ (3x0.6 mL) or the reaction mixture was concentrated and 2,4-dimethoxy-acetophenone (**97**) (14 - 21 mg, 0.078-0.12 mmol) was added as internal standard and the ¹H NMR spectrum registered as above.

Neat: *Preparation of samples.* Reaction mixtures were prepared by mixing DABCO (**3**) (4.8 mg, 0.0425 mmol), ethyl nitroacetate (**1b**) (141 mg, 1.062 mmol) and allyl alcohol (**2d**) (24 mg, 0.425 mmol) and the reaction was kept at 60 °C.

Spectroscopic yield evaluation. Every hour, the reaction mixture was dissolved in CDCl₃ (1 mL) and 2,4-dimethoxy-acetophenone (**97**) (14 - 21 mg, 0.078-0.12 mmol) was added as internal standard and the ¹H NMR spectrum registered as above.

Reaction conditions affecting condensation of nitro compounds and dipolarophiles (Table 6-1 and Table 6-3).

A mixture of nitro compound (1.06 mmol), dipolarophiles (0.425 mmol), base (0.0425 mmol) and water or CHCl₃ (1.4 mL) was kept at 60 °C. After the indicated time, the reaction mixture was concentrated and the crude was

dissolved in CDCl₃ with 2,4-dimethoxy-acetophenone (**97**) (14 - 21 mg, 0.078-0.12 mmol) as internal standard, then as above.

Reaction conditions affecting the enantioselectivity (Table 6-6).

A mixture of nitro compound (1.06 mmol or 0.425 mmol in entries 3-6), dipolarophiles (0.425 mmol or 1.062 in entries 3-6), base (0.0425-0.0848 mmol), Cu(0) or Cu(AcO)₂ (0.0212-0.425 mmol) and water (1.4 mL) was kept at 60 °C. After the indicated time, a portion of the crude was concentrated and was dissolved in dichloromethane (1mg/mL) and analysed with gas-chromatography as illustrated in Chapter 4.

Appendix

List of Contents

<i>Ab initio</i> calculation.....	206
Table A-1/A-4. ¹ H and ¹³ C NMR chart of isoxazoles in Chap. 5....	212
Figure A-5/A-6. ¹ H and gHMBC NMR spectrum of 84j	216
Figure A-7/A-8. ¹ H and gHMBC NMR spectrum of 88	217

Ab initio calculations

In order to understand the role of copper(II) salt in the processes shown so far, in particular in the competition between Michael reaction and cycloaddition-condensation (see Chapter 3), some *ab initio* calculations have been carried out. First of all the interaction between nitro compound and DABCO (**3**) was analysed: the optimized geometry of the complex methyl nitroacetate (**1j**)-DABCO (**3**) is depicted in Figure A-1 where two structures are possible.

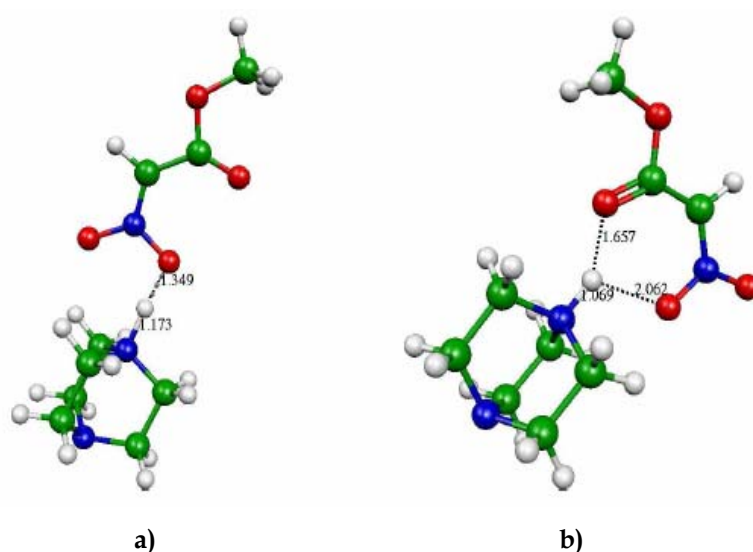


Figure A-1. a) The H-bond is between the base and an oxygen atom of the NO₂ group. b) The H-bond is between the base and two oxygen atoms, one of the NO₂ group and the other of the C=O group. The structures have been optimized at B3LYP/6-31d(d) level of theory.¹⁶⁹

The complex shown in Figure A-1 b, where the H-bond is between the base and two oxygen atoms, one of the NO₂ group and the other of the

¹⁶⁹ Glukhovtsev, M. N.; Bach, R. D.; Pross, A.; Radom, L. *Chem. Phys. Lett.* **1996**, 260, 558–564.

ester group, is slightly lower in energy by 0.77 kJ mol^{-1} than the other structure in Figure A-1 a, where a single $\text{O}\cdots\text{H}$ interaction is present. In Figure A-1 are also illustrated the calculated distances between the atoms involved in the H-bonds. The interaction between base and nitro compound is confirmed by an ^1H NMR analysis, where DABCO (**3**) was titrated with ethyl nitroacetate (**1b**). In Figure A-2 the signal of DABCO (**3**), plotted *versus* the molar ratio between ethyl nitroacetate (**1b**) and DABCO (**3**), shows a shift from 2.77 to 3.07, as the base is increasingly protonated. At the same time the signal of CH_2NO_2 gets broader.

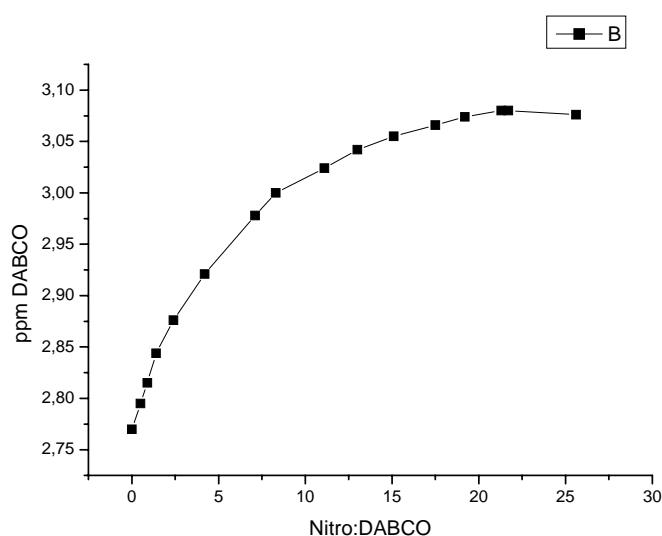


Figure A-2.

Then the dipolarophile was introduced in the study: methyl nitroacetate (**1j**), DABCO (**3**) and acrylonitrile (**36c**) have been chosen to reduce the computational load because of the minor number of atoms involved, and the structural minima in vacuum with a series of geometrical optimizations were calculated.

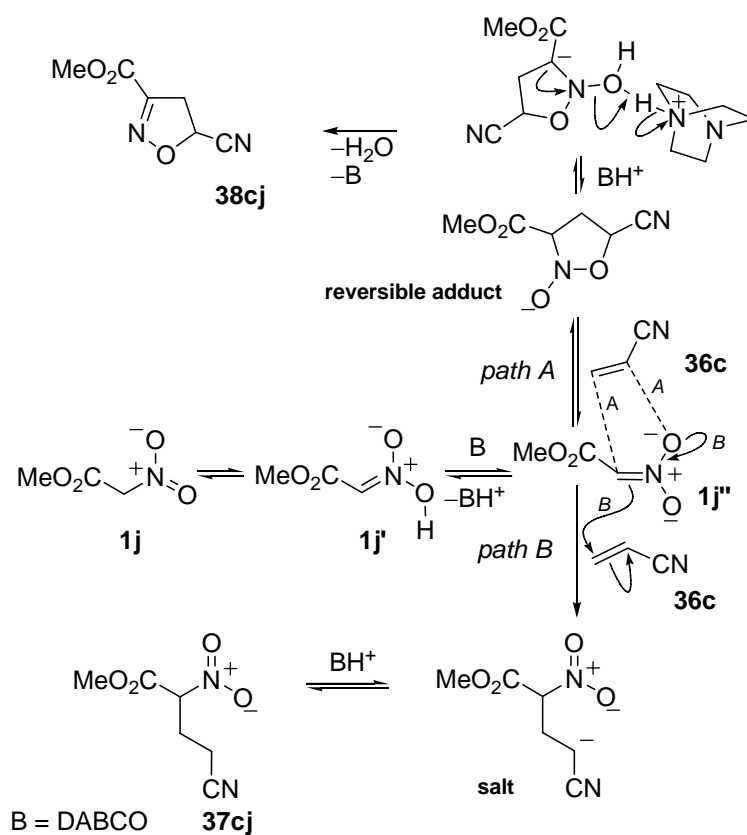
The *ab initio* “all electrons” computations have been executed by Gaussian¹⁷⁰ and Gamess^{171,172} programs. The energy obtained from the *ab initio* calculations of the species **1j** and **1j'** (Scheme A-1) involved in the equilibrium show a lower value for **1j** of 17.83 kJ mol⁻¹ with respect to **1j'**. In vacuum an high barrier between **1j** and **1j'** species is present, that is overcome in the reaction conditions; in solution both the tautomers are then present. When DABCO (**3**) was added, the salt **1j''** is the only detectable species.

Further, copper ion was then introduced: nitroacetic acid dianion has been reported to give a strong complex with Cu(II) ion¹¹⁶ and by analogy a similar behaviour with the monoanion of methyl nitroacetate (**1j'**) has been reported.¹¹⁷ In a possible complex the ion is coordinated by two nitro compound through one oxygen of the nitro group and one oxygen of the carbonyl group to form a squared base of an octahedral coordination. The axial positions are occupied by DABCO (**3**) which is present in solution with the formation of Cu-N interactions; two configurations have been obtained and they are reported in Figure A-3.

¹⁷⁰ Frisch *et al.*, *Gaussian 98, Revision A.11*; Gaussian Inc.:Pittsburg, PA, **1998**.

¹⁷¹ Schmidt, M. W.; Baldrige, K. K.; Boatz, J. A.; Elbert, S. T.; Gordon, M. S.; Jensen, J. H.; S. Koseki and, N. M.; Nguyen, K. A.; Su, S.; Windus, T. L.; Dupuis, M.; Montgomery, J. A. *J. Comput. Chem.* **1993**, *14*, 1347-1363.

¹⁷² Dykstra, C. E.; Frenking, G.; Kim, K. S.; Scuseria, G. E. *Theory and Applications of Computational Chemistry: the first forty years*; Elsevier: Amsterdam, **2005**.



Scheme A-1

In the first complex **a** a plane of symmetry is present and the structure belongs to the C_s point group (where the methyl nitroacetates (**1j**) are in cis configuration); in the complex **b** an inversion axis is present and the structure belongs to the C_i point group. The C_i complex has lower energy than the other complex and this small difference (4.36 kJ mol^{-1}) is probably due to the methyl groups which are in trans configuration.

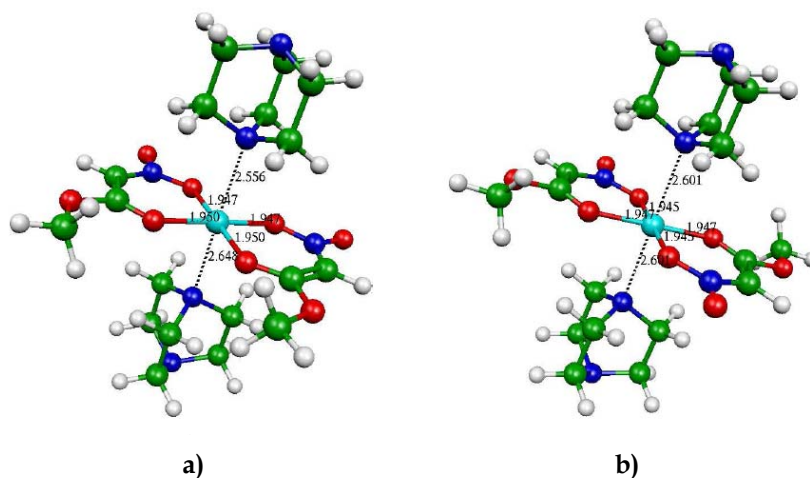


Figure A-3. Optimised structures for the complex Cu(II)-methyl nitroacetate-DABCO: a) structure belongs to C_s point group; b) structure belongs to C_i point group.

In order to confirm this result an ^1H NMR spectra of DABCO (**3**) and Cu(II) salt (in absence of the nitro compound) was registered: the spectra show a good coordination between the two species. Since Cu(II) is a paramagnetic metal ion, a relaxation rate increase is observed leading to broad or undetectable signals in NMR spectra. Thus, when a catalytic amount of Cu(II) is added, the signals of DABCO (**3**) disappear in the NMR spectra, indicating the formation of Cu–N interactions.

As basis set the 6-31g(d) has been chosen either for this metal ion and for the organic species even if a lanl2dz basis type may be more appreciable in describing the copper ion behaviour; the use of different basis may affect the structural data, such as distances or angles, but not the geometrical structure of the whole complexes.

In the reaction condition (in particular at 60 °C) both the Cu-complexes may be present; at this point acrylonitrile (**36c**) was included in calculation and a geometric optimization was carried out. The

dipolarophile was initially put in a favourable position for the cycloaddition, but during the simulation, the olefin **36c** gets off the position and rearrange in a way that the atoms do not interact anymore each other to encourage the cycloaddition (Figure A-4). At this point the complex at lower energy is shown in Figure A-4, with an arrangement of the ligands close to that of Figure A-3, **a** (cis) rather than **b** (trans). The addition of acrylonitrile causes to a reorganization of the structures, loosing the octahedral coordination in favour of a distorted square pyramid; in fact during the optimization step, one molecule of DABCO (**3**) in axial position gets far away from the metal (the distance increases from 2.601 Å to 5.369 Å for *Ci* and from 2.556 Å to 5.489 Å for *Cs*).

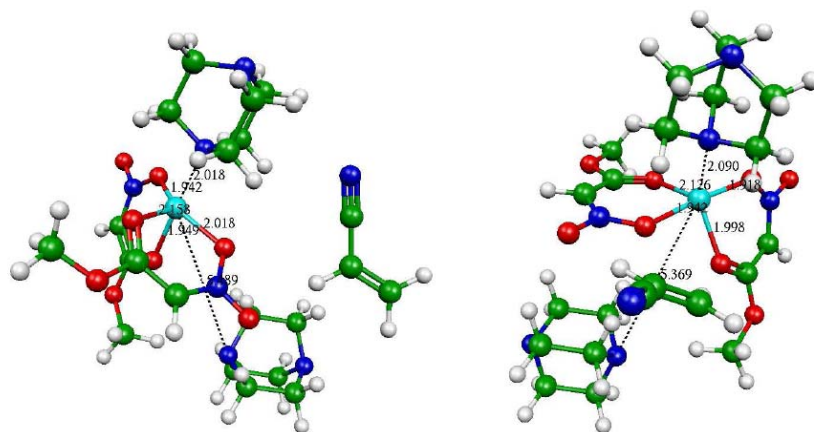


Figure A-4. Optimised geometry for the complex of Cu with two molecules of methyl nitroacetate (**1j**) two molecules of DABCO (**3**) and one molecule of acrylonitrile (**36c**). The figures represent the same structures in two different point of view.

The level of theory used does not reproduce van der Waals effects and they may be representative of the stabilization of acrylonitrile (**36c**) in such a position to favour the cycloaddition. The change of the level of theory could give a more realistic coordination structure of the species involved in the reaction.

Table A-1. ^{13}C NMR chart (CDCl_3 100.58 MHz) of isoxazoles illustrated in Chapter 5.

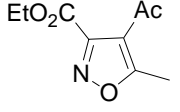
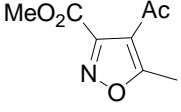
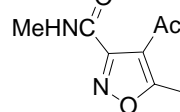
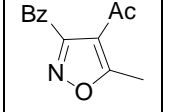
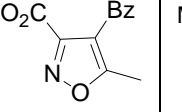
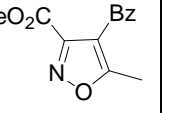
						
	82b	82j	82g	82a	84b	84j
Carbon δ = :						
C-3	154.3	154.0	156.1	159.6	155.0	154.8
C-4	117.0	117.2	116.8	117.5	116.1	116.3
(Me) C-5	(13.2) 174.6	(13.2) 174.8	(13.3) 175.3	(13.4) 174.5	(12.2) 173.1	(12.3) 173.0
C-3 substituent	(13.9; 62.9) 160.4	(53.4) 160.8	(26.4) 159.6	187.5	(13.5; 62.4) 159.2	(52.9) 159.7
C-4 substituent	(30.4) 192.0	(30.4) 192.1	(31.1) 193.3	(30.2) 191.6	188.2	188.1
Ph-C _{ipso}	-	-	-	135.6	137.7	137.6
Ph-C _{ortho}	-	-	-	130.3	128.9	128.9
Ph-C _{meta}				128.9	128.7	128.8
Ph-C _{para}	-	-	-	134.8	133.6	133.7

Table A-2. ¹H NMR chart (CDCl₃ 400 MHz) of isoxazoles illustrated in Chapter 5.

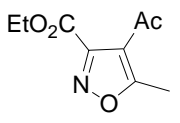
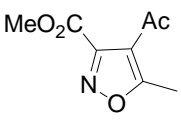
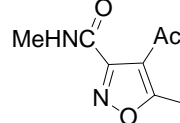
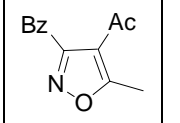
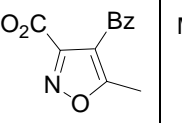
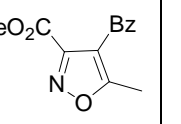
						
	82b	82j	82g	82a	84b	84j
Proton δ = :						
C-3 substituent	1.39t(4.44q)	3.98s(-)	3.00s(6.85brs)-	-	1.03t(4.08q)	3.65s(-)
C-4 substituent	2.46s	2.47s	2.56s	2.32s	-	-
CH ₃ (C-5)	2.63s	2.64s	2.62s	2.75s	2.52s	2.52
Ph- <i>H</i> _{ortho}	-	-	-	7.99 – 8.03	7.72 – 7.75	7.70 – 7.76
Ph- <i>H</i> _{para}	-	-	-	7.63 – 7.68	7.56 – 7.61	7.56 – 7.62
Ph- <i>H</i> _{meta}	-	-	-	7.48 – 7.53	7.41 – 7.48	7.43 – 7.50

Table A-3. ^{13}C NMR chart (CDCl_3 100.58 MHz) of isoxazoles illustrated in Chapter 5.

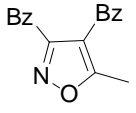
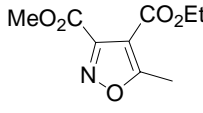
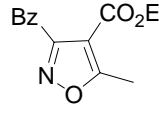
			
	84a	86j	86a
Carbon δ = :			
C-3	160.7	155.4	160.4 or 160.6
C-4	117.1	108.7	109.2
(Me) C-5	(12.5) 172.4	(12.7) 175.2	(12.8) 175.2
C-3 substituent	185.4	160.5	186.8
C-4 substituent	188.1	(14.0; 61.3) 160.4	(13.6; 61.1) 160.4 or 160.6
Ph-C _{ipso}		-	135.7
Ph-C _{ortho}	C-3: 130.2 C-4: 128.8	-	129.8
Ph-C _{meta}		-	128.7
Ph-C _{para}	C-3: 134.3	-	134.4

Table A-4. ¹H NMR chart (CDCl₃ 400 MHz) of isoxazoles illustrated in Chapter 5.

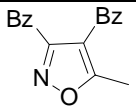
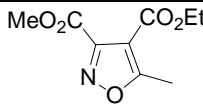
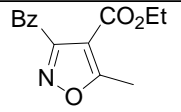
			
	84a	86j	86a
Proton δ = :			
C-3 substituent	-	3.95	-
C-4 substituent	-	1.31t (4.28q)	1.00t (4.09q)
CH ₃ (C-5)	2.56s	2.67s	2.75s
Ph- <i>H</i> _{ortho}	C-3: 7.99 – 8.03 C-4: 7.64 – 7.69		7.87 – 7.92
Ph- <i>H</i> _{para}			7.59 – 7.64
Ph- <i>H</i> _{meta}			7.45 – 7.50

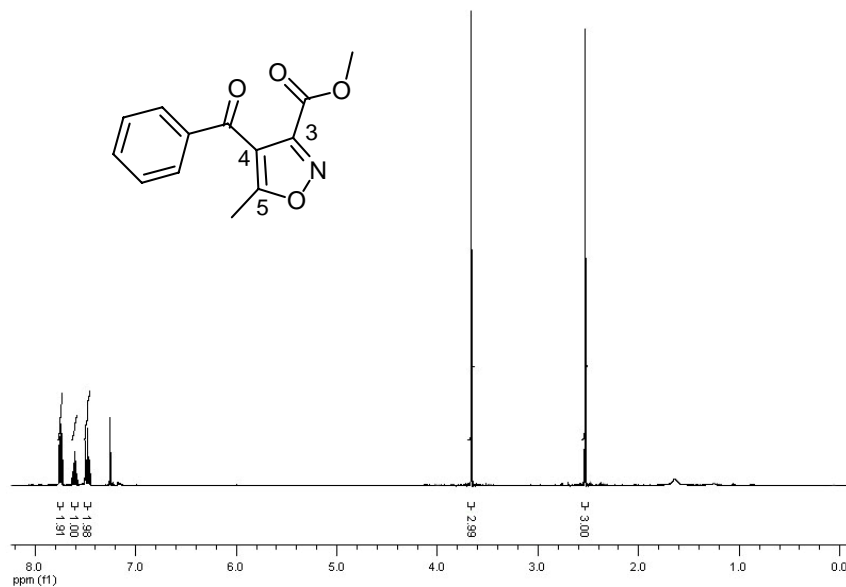
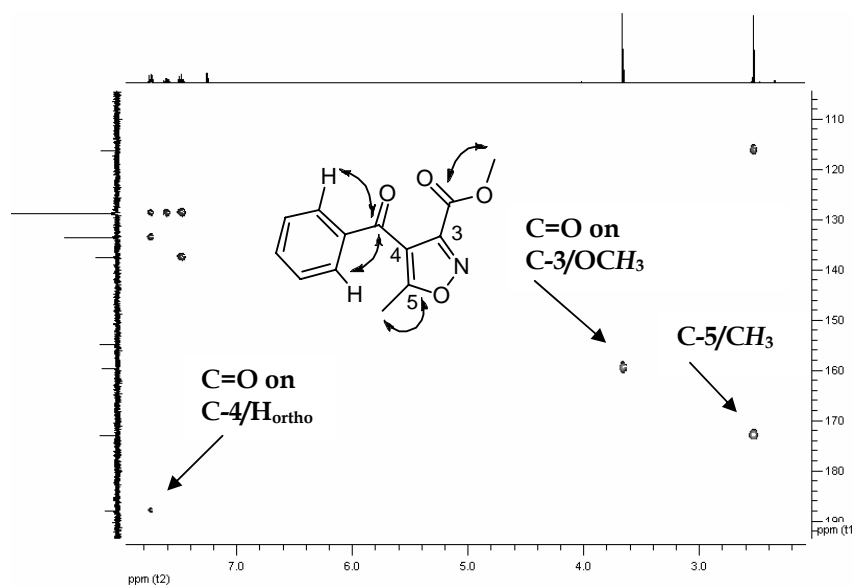
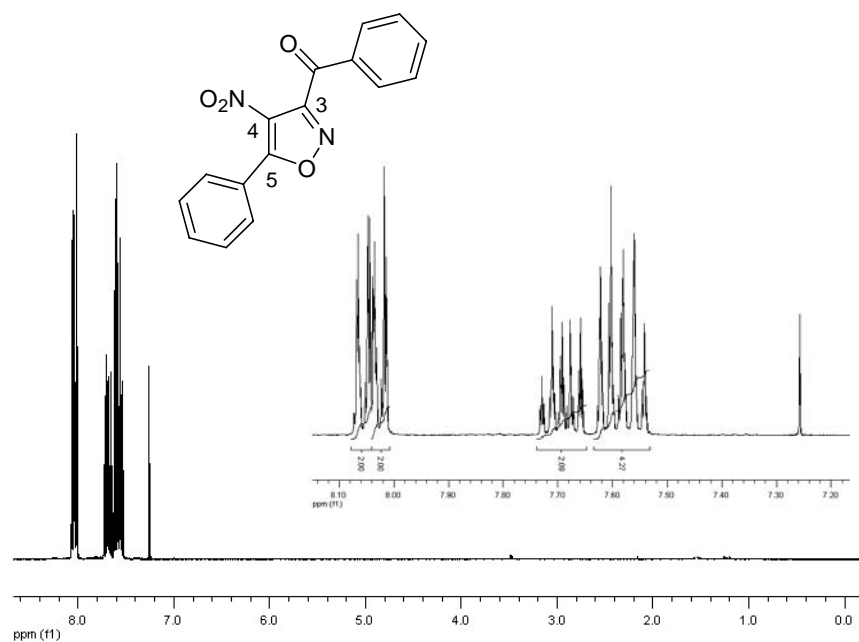
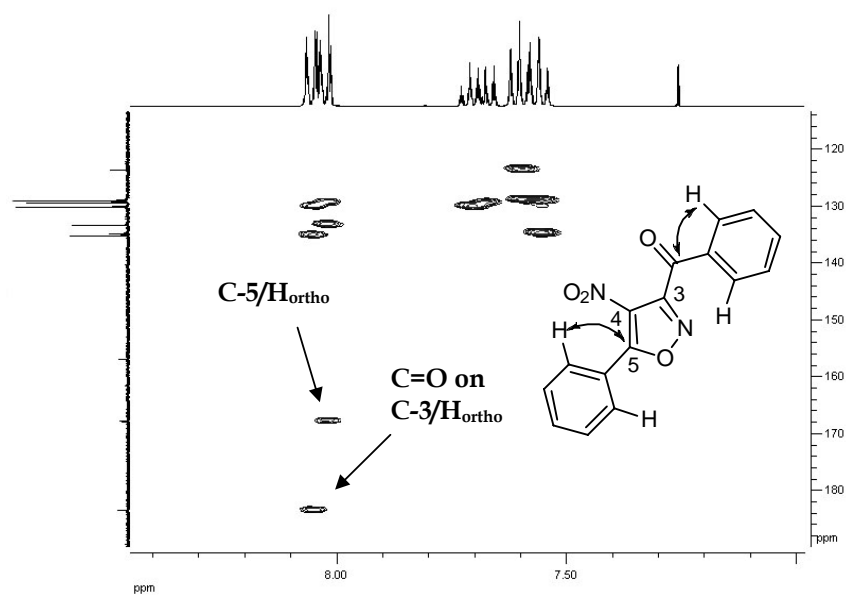
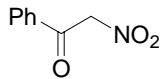
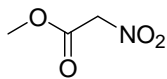
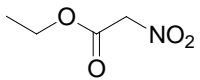

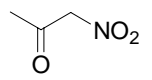

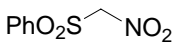

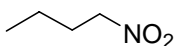
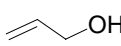
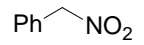
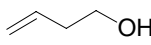
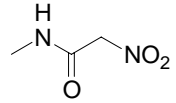
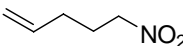
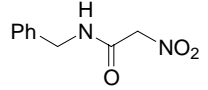
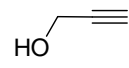
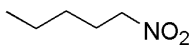
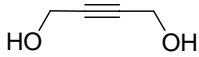
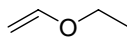
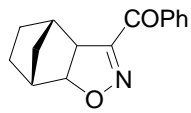
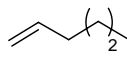
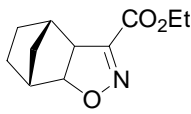
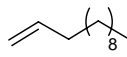
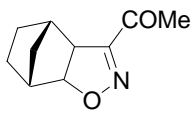

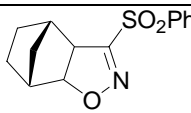
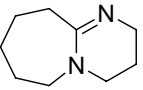
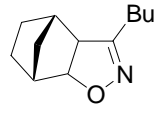
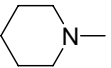
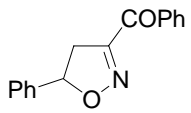
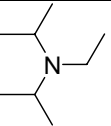
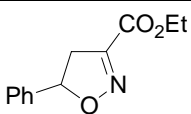
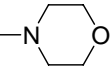
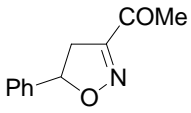
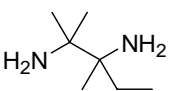
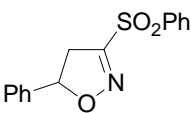
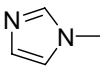
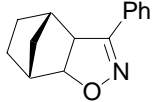
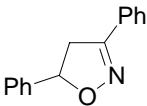
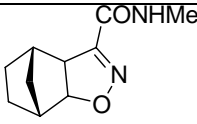
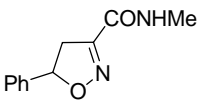
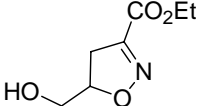
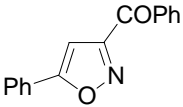
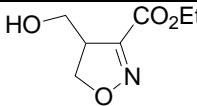
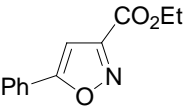
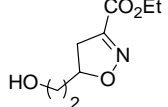
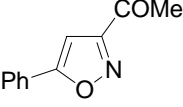
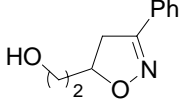
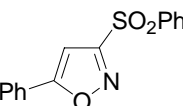
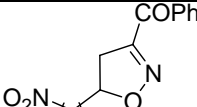
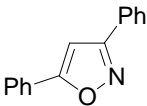
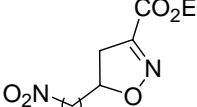
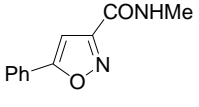
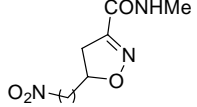
Figure A-5. ^1H NMR (CDCl_3 , 400 MHz) of isoxazole **84j**.**Figure A-6.** gHMBC (CDCl_3 , 400 MHz) of isoxazole **84j**.

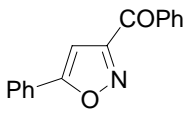

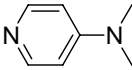
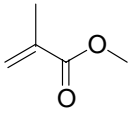
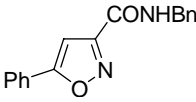
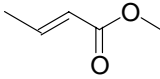
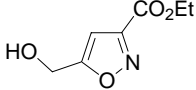
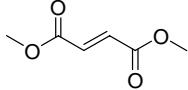
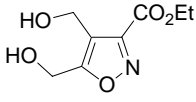
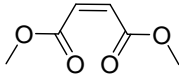
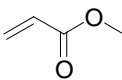
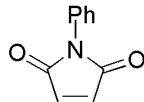
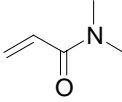
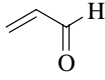

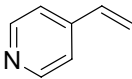
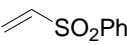
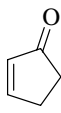
Figure A-7. ^1H NMR (CDCl_3 , 400 MHz) of isoxazole **88**.**Figure A-8.** gHMBC (CDCl_3 , 400 MHz) of isoxazole **88**.

Compound List

Number	Structure	Number	Structure
1a		1j	
1b		2a	
1c		2b	
1d		2c	
1e		2d	
1f		2e	
1g		2f	
1h		2g	
1i		2h	

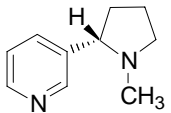
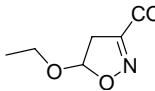
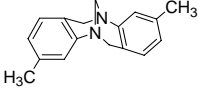
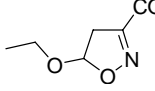
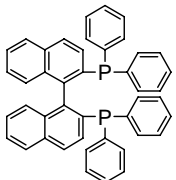
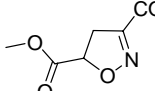
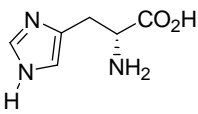
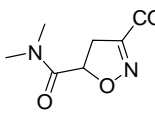
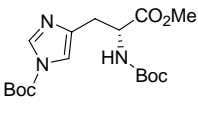
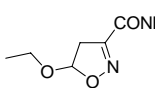
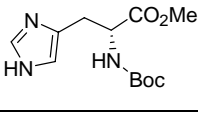
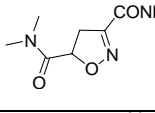
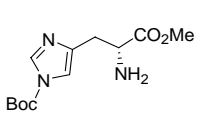
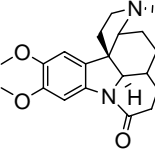
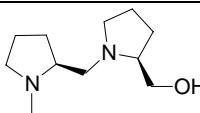
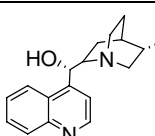
Number	Structure	Number	Structure
2i		4	
2j		5	
2k		6	
3		7	
3b		8	
3c		9	
3d		10	
3e		11	
3f		12	

Number	Structure	Number	Structure
13		22	
14		23	
15		24	
16		25	
17		26	
18		27	
19		28	
20		29	
21		30	

Number	Structure	Number	Structure
31		36e	
32		36f	
33		36g	
34		36h	
35		36i	
36a		36j	
36b		36k	
36c		36l	
36d		36m	

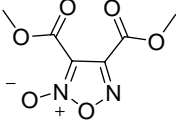
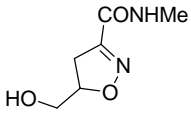
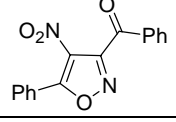
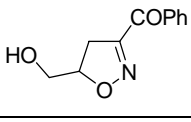
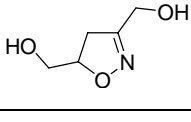
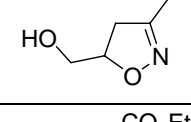
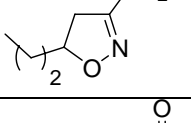
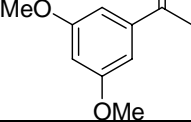
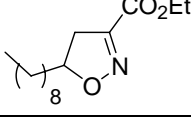
Number	Structure	Number	Structure
36n		37l	
36o		37m	
36p		37n	
37a		38a	
37b		38b	
37c		38c	
37d		38d	
37e		38e	
37k		38f	

Number	Structure	Number	Structure
38g		42	Me ₂ SO ₂
38h		43	PriO ₂ C-CH(OH)-CH(OH)-CO ₂ iPr
38i		44	
38j		45	
38l		46	
38m		47	
39		48	
40g		49	
41		50	

Number	Structure	Number	Structure
51		58	
52		59	
53		60	
54		61	
55		62	
56		63	
56bis		64	
57		65	

Number	Structure	Number	Structure
66		74	
67		75 (sin-4 and anti-4)	
68		75 (sin-5 and anti-5)	
69		76	
70		77 (sin-4 and anti-4)	
71		77 (sin-5 and anti-5)	
72		78	
73		79 (sin-4 and anti-4)	

Number	Structure	Number	Structure
79 (sin-5 and anti-5)		84a	
80		84b	
81		84j	
82a		85	
82b		86a	
82g		86j	
82j		87a	
83		87b	

Number	Structure	Number	Structure
87j		92	
88		93	
89a	$\text{PhOC}\equiv\text{N}^+\text{O}^-$	94	
89b	$\text{EtO}_2\text{C}\equiv\text{N}^+\text{O}^-$	95	
89j	$\text{MeO}_2\text{C}\equiv\text{N}^+\text{O}^-$	96	
90	$\text{HOCH}_2\text{CH}_2\text{NO}_2$	97	
91	$\text{CH}_3\text{CH}_2\text{NO}_2$	98	

List of Abbreviations

1,3-DC	1,3-Dipolar cycloaddition
4-DMAP	4-Dimethylaminopyridine
BINOL	1-1'-Bi-2-naphthol
DABCO	1,4-Diazabicyclo[2.2.2]octane
DBU	1,8-Diazabicyclo[5.4.0]undec-7-ene
DCM	Dichloromethane
DIPEA	N,N-Diisopropylethylamine
EWG	Electron withdrawing group
GC	Gas Chromatography
NMI	N-Methylimidazole
NMM	N-Methylmorpholine
NMP	N-Methylpiperidine
PyBrop	Benzotriazol-1-yl-oxytripyrrolidinophosphonium hexafluorophosphate
TMPDA	Tetramethyl propylendiamine

Aknowledgements

Tutor Prof. Francesco De Sarlo

Dr Luca Cecchi

Università degli Studi di Firenze

Co-Tutor Dr Fabrizio Machetti

ICCOM-CNR di Firenze

Dr Luca Guideri

Prof. Fabio Ponticelli

Univeristà degli Studi di Siena

Dr Marco Pagliai

Dr Cristian Faralli

Prof. Gianni Cardini

Prof. Vincenzo Schettino

Università degli Studi di Firenze

Ministero dell'Istruzione,

Università e Ricerca (MIUR,

Progetto PRIN COFIN 2005)

Ente Cassa di Risparmio di Firenze

Financial Support