



UNIVERSITÀ  
DEGLI STUDI  
FIRENZE

# FLORE

## Repository istituzionale dell'Università degli Studi di Firenze

### **A computer-based system for dyeing leather patch edges**

Questa è la Versione finale referata (Post print/Accepted manuscript) della seguente pubblicazione:

*Original Citation:*

A computer-based system for dyeing leather patch edges / Y.Volpe;R.Furferi;L.Governi. - In:  
INTERNATIONAL JOURNAL OF COMPUTER AIDED ENGINEERING AND TECHNOLOGY. - ISSN 1757-2657. -  
STAMPA. - 6(2):(2014), pp. 139-158. [10.1504/IJCAET.2014.060296]

*Availability:*

The webpage <https://hdl.handle.net/2158/796658> of the repository was last updated on

*Published version:*

DOI: 10.1504/IJCAET.2014.060296

*Terms of use:*

Open Access

La pubblicazione è resa disponibile sotto le norme e i termini della licenza di deposito, secondo quanto stabilito dalla Policy per l'accesso aperto dell'Università degli Studi di Firenze (<https://www.sba.unifi.it/upload/policy-oa-2016-1.pdf>)

*Publisher copyright claim:*

La data sopra indicata si riferisce all'ultimo aggiornamento della scheda del Repository FloRe - The above-mentioned date refers to the last update of the record in the Institutional Repository FloRe

(Article begins on next page)

---

## **A computer-based system for dyeing leather patch edges**

---

Y. Volpe\*, R. Furferi and L. Governi

Department of Industrial Engineering,  
University of Florence,  
via S. Marta, 50139 Firenze, Italy  
E-mail: yary.volpe@unifi.it  
E-mail: rocco.furferi@unifi.it  
E-mail: lapo.governi@unifi.it  
\*Corresponding author

**Abstract:** The visual appearance of seamless dyed edges of luxury leather goods represents a key issue in terms of quality grading since a high-quality leather has to be characterised by homogeneously coloured and shaped edges with uniform ink thickness. Despite a huge literature produced by scientific and technical community to automate many leather manufacturing processes, since leather patches are often characterised by a free-form shape, any attempt of automating leather edges dyeing produced unsatisfactory and inaccurate results. In order to overcome the drawbacks of the existing approaches, the main objective of the present work is to provide a computer-based system for automatically dyeing leather patches edges. The described system includes: 1) a machine vision (MV) hardware equipment, consisting of both illumination and a high resolution acquisition device, devoted to patches edge detection; 2) a pantograph whose dyeing tool is moved along leather edges; 3) a series of computer-based methods for the automatic extraction of the leather patches outlines. Extensive testing performed using the developed machine demonstrated its effectiveness in delivering fast, automatic and high quality edge finishing in a reliable and repeatable way.

**Keywords:** leather dyeing; machine vision; process automation.

**Reference** to this paper should be made as follows: Volpe, Y., Furferi, R. and Governi, L. (2014) 'A computer-based system for dyeing leather patch edges', *Int. J. Computer Aided Engineering and Technology*, Vol. 6, No. 2, pp.139–158.

**Biographical notes:** Y. Volpe received his PhD in Machine Design and Construction at the University of Florence, Italy, in 2006. He graduated MSc in Mechanical Engineering at the University of Florence. He is currently working as an Assistant Professor at the Department of Industrial Engineering, University of Florence. He is also an Adjunct Professor of the course 'Computational Graphics' from the Engineering Faculty of the University of Florence. His main scientific interests are: computer aided design, image processing, virtual prototyping, FE simulation, reverse engineering and rapid prototyping. He is the author and co-author of many publications printed in international journals and participated in a number of international conferences. Some latest publications described techniques for comfort-oriented design, machine vision-based systems for industrial processes and spline-based approximation of point clouds.

R. Furferi received his PhD in Machine Design and Construction at the University of Florence, Italy, in 2005. He graduated MSc in Mechanical Engineering at the University of Florence. After working as a Postdoctoral Researcher at the Department of Industrial Engineering of the University of Florence in 2008, he assumed a faculty position as an Assistant Professor for the course 'Mechanical Drafting'. His main scientific interests are: development of artificial vision systems for industrial and textile control, artificial neural networks, colorimetry, reverse engineering and rapid prototyping. He is the author and co-author of many publications printed in journals and presented on international conferences. Some latest publications described methods for colour assessment of textiles, algorithms for 3D reconstruction of objects from orthographic views and ANN-based systems for industrial process.

L. Governi received his PhD in Machine Design and Construction at the University of Florence, Italy, in 2002. He graduated MSc in Mechanical Engineering at the University of Florence. After working as a Postdoctoral Researcher at the Department of Industrial Engineering of the University of Florence, in 2005 he assumed a faculty position as an Assistant Professor for the courses of 'Reverse Engineering' and 'Design and Modelling Methods'. His main scientific interests are: machine vision and reverse engineering, colorimetry, tools and methods for product design and development. He is the author and co-author of many publications printed in international journals and participated to a number of international conferences. Some latest publications described techniques oriented towards the 3D reconstruction from orthographic views, vision-based product and process assessment and spline-based approximation of point clouds.

---

## 1 Introduction

The typical process for producing leather goods (e.g., handbags, leatherwear, luxury briefcases, travel bags, purses, wallets and leather diaries) involves a number of phases such as the aesthetic-functional design, the selection of raw material from the tannery, the 'preparation' of the patches, the sewing, etc. Among them, the 'preparation' phase, consisting of a process chain starting from the raw leather (coming out from the tannery) and ending with the production of finished leather patches, is one of the most important. In detail, the raw leather is cut in a desired shape by using cutting machines by means of, for instance, hollow punches or LASER-based technologies. Once the patches are cut from leather, their edges are really coarse and characterised by a number of flaws (see Figure 1).

In order to smooth the patch edges, they have to be ground and polished. Only when the patch edges are sufficiently smoothed, a dyeing process can take place with the aim of regularly ink them. Grinding, polishing and dyeing are usually performed more than once before the leather patches are considered to be of good quality. The visual appearance of seamless dyed edges represents a key issue in terms of quality grading; a high-quality leather has to be characterised by homogeneously coloured and shaped edges with uniform ink thickness as depicted in Figure 2.

**Figure 1** Cut leather patches characterised by a number of flaws (see online version for colours)

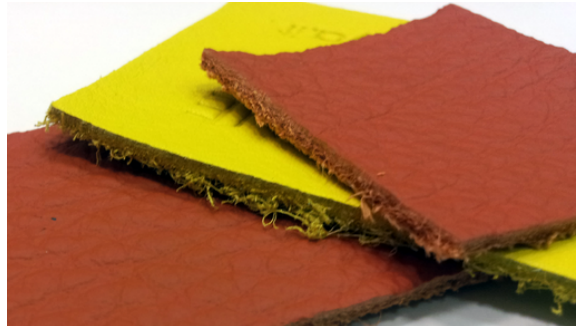

**Figure 2** Leather patches characterised by high-quality dyed edges (see online version for colours)



Except for belts, whose simple geometry allows in some cases to use automatic dyeing machines, edge dyeing of leather patches is, still today, manually performed using particular grinding-polishing-dyeing machines available in the market. Dyeing is usually performed by using machines provided with cylindrical ink rollers capable of providing, steadily, the right proportion of ink once the patch is manually and delicately pushed against the rollers themselves (see Figure 3).

A skilled operator will pay close attention to grinding and dyeing performance, particularly when a new combination of tool, material and colours are being tried. However, since dyeing process may be repetitive and time-consuming, the quality of obtained product highly depends not only on operator expertise but also on ensuing fatigue and inattentiveness. Moving from these considerations, it is evident that carrying out manually the edge dyeing procedure represents a bottleneck for the entire leather 'preparation' process.

In the last years, great efforts have been made by scientific and technical community to automate many leather manufacturing processes such as nesting, cutting, finishing and gluing. A machine-vision-based approach to grading leather hides for footwear industry is proposed in Hoang and Nachimuthu (1996); tools for automatically inspecting leather surfaces have been proposed so far in literature (Branca et al., 1996; Hoang et al., 1997; Fuqiang et al., 2006; Yeh and Perng, 2001; Neto et al., 2005; Pistori et al., 2007) with the aim of detecting scars, mite nests, warts and other 'defects'.

'In recent years, the market has been flooded with several commercial nesting software with different capabilities' (Elamvazuthi et al., 2009). Moreover, many effective solutions have been proposed by many researchers for nesting when pieces and containing region are both rectangular and irregular shapes (Hopper and Turton, 2001; Bennell et al., 2001; Gomes and Oliveira, 2002; Wu et al., 2003; Whitwell, 2004).

**Figure 3** Manual dyeing (see online version for colours)



Dealing with cutting machines (both based on LASER and water jet technology) they have also undergone a significant evolution (Koike, 2010); generally speaking, such machines comprise of a table where the leather is arranged and of a cutting station provided with the cutting device. These systems may be, substantially, recognised as CNC machines which process 2D CAD sketches providing the proper cut path. These systems overcome the limitations of classical leather cut, based on pneumatics presses and hollow punches.

In the field of leather sole manufacturing, systems based on force feedback guidance have been proposed to finish the edges of complex shaped soles (Nemec and Zlajpah, 2008). However, this approach cannot be applied to edge dyeing because of the high flexibility of leather patches.

Devices using vision systems for gluing leather patches are also commercially available (Maurtua et al., 2012). In such systems, one or more cameras acquire a plane where the leathers are placed; the image is then processed by operators under a CAD-based environment. In particular, starting from the acquired image(s) the experts manually trace the paths to be followed by the gluing system. Such paths are then used for guiding a CNC-based architecture.

This latest technology looks very promising from the point of view of a possible transfer to the edge dyeing process.

Unfortunately, the precision required in dyeing patch edges (considerably higher than the one required in gluing) would oblige the operators to trace the dyeing paths with such an accuracy that the resulting process would be even slower and trickier than the conventional manual one.

To the best of authors' knowledge, no advanced technology has been introduced for dyeing leather patches. In fact, the patent referring to the presently used 'technology' dates back to 1939 (Rosenberg and Brockton, 1939).

In order to overcome the abovementioned drawbacks and to push forward the edge leather dyeing technological state of the art, the main objective of the present work is to

provide a computer-based system for automatically dyeing leather patch edges with high precision. The described system comprises three main parts:

- 1 a machine vision (MV) system devoted to patch edge detection
- 2 a CNC dyeing pantograph (2 axes Cartesian robot) whose dyeing tool is automatically moved along the edges of the leather patches
- 3 a software system performing image-processing-based algorithms for the extraction of the patch outlines.

This paper is structured as follows. In Section 2, the CNC dyeing pantograph developed by the authors is described. In Section 3, the MV system able to properly acquire, in controlled light environment, high resolution images of the leather patches is presented. Section 4 describes the algorithms implemented in order to extract the outlines of the leather patches from the images. Finally, the results obtained by the proposed system are compared against the ones characterising the traditional technique.

## **2 CNC dyeing pantograph**

The main aim of the CNC dyeing pantograph is to dye the edges of leather patches, once these are detected by the MV system described in the next section. Such a pantograph is composed by a frame supporting a working plane (WP) provided with a back illumination system obtained by using an array of high frequency florescent illuminant (see Figure 4). Back illumination has been implemented in the system since it allows to easily discriminate the leather patches from the background independently from surface finish (glossy or matte), colour and texture.

Leather patches to be dyed, manually placed by an operator, are supported by a set of magnets and held by metallic elements (see Figure 5).

The WP, whose size is 400 mm × 300 mm, consists of a three layer sandwich (see Figure 6). The bottom layer is made of an opaque white glass used with the aim of uniformly diffuse the back-light. The central layer consists of a metal wire netting. Such a grid assures the magnets supporting the patches to be held in position thanks to the magnetic field generated by the pair magnets-grid. The top layer consists of a transparent Plexiglass sheet; its purpose is to make flat the surface on which the magnet lies and to protect the inner layers from the inevitable drop of ink from the dyeing tool (being understood that the ink is washable and so it can be easily manually removed by an operator).

The frame supports also a two axes pantograph thus allowing the movement of an appositely designed dyeing tool (feed rate 25 mm/s) by means of two motors. The dyeing tool is made of a cylindrical felt-tip, housed by a tank containing a quantity of water-based ink. Due to the high viscosity of the ink, a compressed air circuit has been used with the aim of sending a variable pressure to the tank thus allowing tip soaking (see Figure 7), during dyeing phase. In order to prevent the ink from drying on the felt-tip during idle times, the dyeing tool rests in a 'home' position with the tip immersed in a tank filled with water.

**Figure 4** Conceptual design of CNC dyeing pantograph

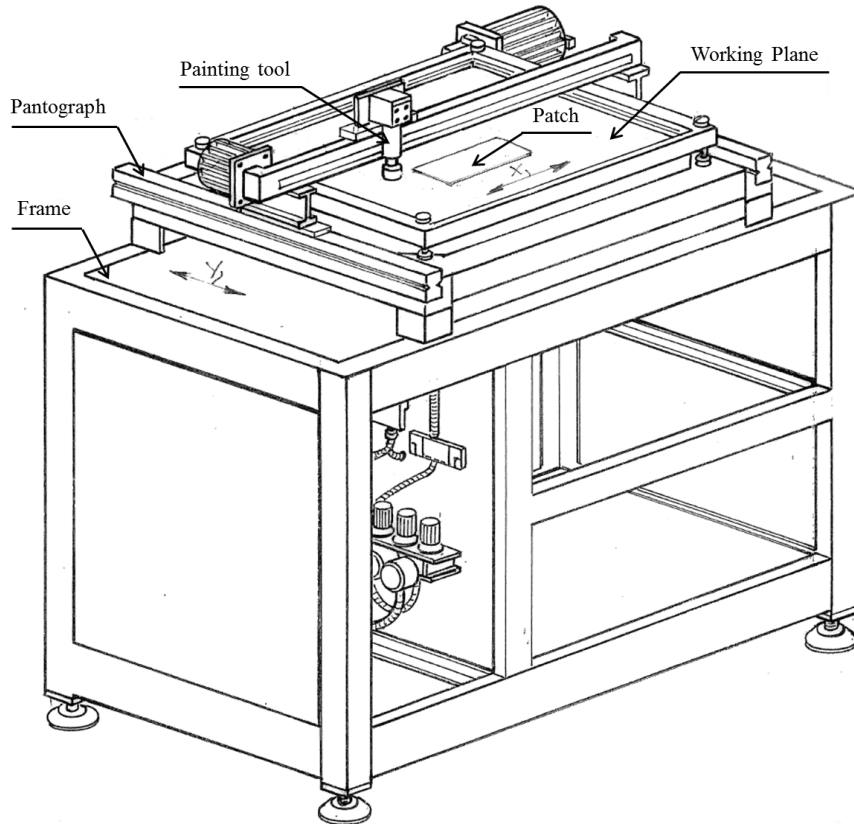

**Figure 5** Leather patches supported by a set of magnets and held by metallic elements (see online version for colours)

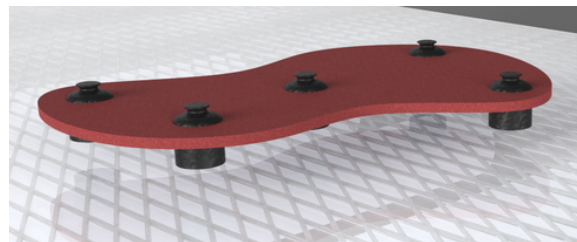

The dyeing tool has two independent degrees of freedom: vertical translation and rotation along vertical axis. The translation is assured by the same compressed air circuit used for ink distribution and comprises only two positions (lower and upper). The lower position is used during both idle time in ‘home’ position and dyeing process. The upper position is necessary when the tool needs to access the water tank and when inner outlines are dyed (in case of holed patches). The rotation, performed by a devoted motor, allows the contact between the tip and the leather edge to continuously vary, thus avoiding the possible drying of the felt-tip during dyeing.

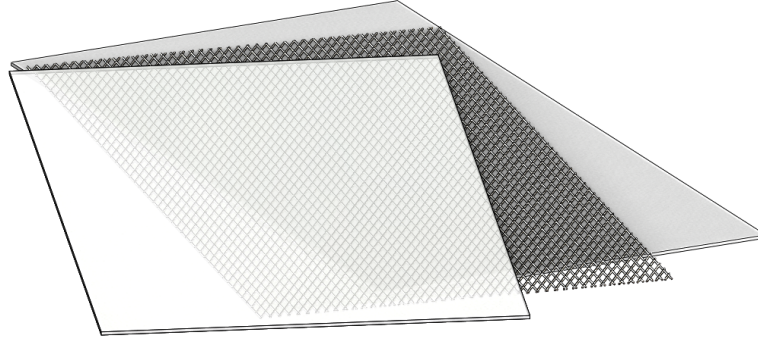
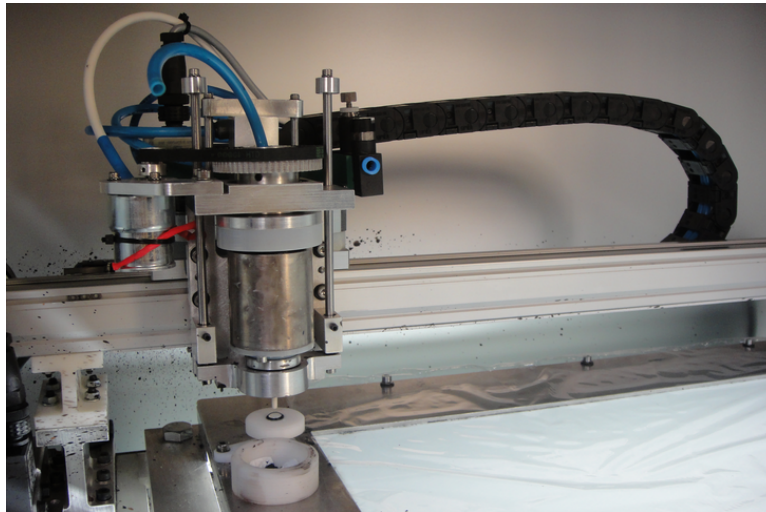
**Figure 6** Three layer sandwich working plane**Figure 7** Dyeing tool (see online version for colours)

### 3 MV system

The MV system is required to automatically detect the edges of a series of leather patches placed on the working plane so that the dyeing tool can approach the edge itself at a distance of about 0.2 mm. A lower distance leads the dyeing tool to deposit undesired ink onto leather patch surface; a greater distance does not allow to properly ink edges. Hence, a spatial resolution at least equal to 0:1 mm/pixel is recommended for the MV system. Therefore, image acquisition is performed by means of a high resolution (18.0 MPixel) Canon EOS 550D camera provided with a 22.3 mm  $\times$  14.9 mm CMOS sensor. The camera, equipped with a CANON EF 50 mm f/1.8 focal length lens, is positioned along a direction approximately orthogonal to the working plane; the distance between the camera and the plane is about 1,400 mm. As a result, the camera acquires an area equal to 480 mm  $\times$  320 mm, large enough for acquiring the entire WP.

Using the maximum allowable resolution of the camera (5,184 pixel  $\times$  3,456 pixel), the resulting spatial resolution is in 0.093 mm/pixel; this value is considered to be suitable for the minimum required spatial resolution of 0.1 mm/pixel. The camera is connected to a PC (Intel<sup>®</sup>Core<sup>™</sup>i5, 2 Gb RAM) by means of an USB 2.0 port and the images are managed by using a graphical user interface (GUI) appositely developed in MATLAB<sup>®</sup> environment.

The entire system is embedded into a sealed cabin so that the contribution of the environmental light is not relevant.

#### **4 Image processing-based method and algorithms**

One of the most challenging issues confronted in the present work is the achievement of an extremely high accuracy on relatively large working area required in the detection of leather edges in order to obtain a high quality dyeing. As already stated in the introductory section, in fact, the dyeing tool cannot be guided by a force feedback-based system due to the high flexibility of leather patches.

As known, edge detection accuracy is affected by many factors, one of the most relevant being camera lens distortion so that this issue needs to be taken into account.

Therefore, the devised system includes:

- 1 a camera calibration method capable of compensating the optical distortions caused by camera lenses (intrinsic camera calibration)
- 2 an edge detection algorithm able to detect leather borders
- 3 a method for accurately referring (undistorted) image coordinates to the CNC reference frame (extrinsic camera calibration)
- 4 a method for correcting the extracted edges depending on the leather patch thickness.

Finally, since the possibility of processing a number of leather patches with a single image acquisition must be assured, a ‘path definition algorithm’ to guide the dyeing tool movement among different patches must also be developed. Each of the abovementioned ‘ingredients’ is detailed in the following subsections.

##### *4.1 Camera intrinsic calibration*

As widely known (Bouguet and Perona, 1998), camera calibration, often referred to as camera resectioning, is the process of finding the true parameters of the camera that produced a given image. Accurate camera calibration and orientation procedures are a necessary prerequisite for the extraction of precise and reliable metric information from images (Liverani et al., 2010). Usually, a camera is considered intrinsically calibrated if the principal distance, principal point offset and lens distortion parameters are known. In this particular application objects to be acquired always lies on the same plane whose position remains unvaried with respect to the cameras. Moreover, objects themselves are approximately flat with a very low thickness (about 1 ÷ 2 mm). As a consequence no 3D reconstruction is required and to derive a complete pinhole model for the cameras is not necessary. Due to fixed acquisition plane position, calibration may be carried out by means of a flat calibration pattern lying on the working plane. Such a calibration pattern,

consisting of a checker-board with checkers 10 mm × 10 mm, is acquired in a number of different positions and orientations in front of the camera at an average distance approximately equal to the one between the camera and the working plane (so to perform the calibration with reference to a working volume comprising the working plane). Practically, a set of 25 images of the calibration pattern in different positions is acquired which is subsequently intrinsically calibrated in order to compute focal distance and distortion model coefficients. Although a number of different calibration methods and distortion models have been investigated by the authors (Furferi et al., 2011a), in the present work this procedure is performed according to the widely known approach described in Weng et al. (1992), and Clarke and Fryer (1998), since it proved to be the most effective in properly calibrating the system.

With reference to Weng et al. (1992), the results of camera calibration consist in determining the following parameters:

- Camera matrix **KK**.
- Focal distances  $f_{c,1}$  and  $f_{c,2}$  expressed in units of horizontal and vertical pixels.
- Coordinates of the image principal point,  $c_1$  and  $c_2$ .
- Radial and tangential distortion coefficients (in the image directions x and y)  $k_{c,1}$ ,  $k_{c,3}$  and  $k_{c,4}$ .

Let, now,  $P$  be a generic 3D point of the pattern (see Figure 8). Its coordinates (in the reference frame) may be described by the vector  $P = [x_c, y_c, z_c]$ . As widely known, the projection of point  $P$  onto the image plane  $\pi$  of the camera, taking into account lens distortion (both tangential and radial one) is described by a vector  $X_d = [X_{d,1}, X_{d,2}]$  provided by the following equation:

$$X_d = \mathfrak{F}_r(X_n) \cdot X_n + \mathfrak{F}_t(X_n) \quad (1)$$

where in the simplest case of a 2nd order radial distortion:

$$X_d = \begin{bmatrix} x_c / z_c \\ y_c / z_c \end{bmatrix}$$

$$\mathfrak{F}_r = 1 + k_{c,1} \cdot (X_{n,1}^2 + X_{n,2}^2) \quad (2)$$

$$\mathfrak{F}_t = \begin{bmatrix} 2k_{c,3} \cdot X_{n,1} \cdot X_{n,2} + k_{c,4} (3X_{n,1}^2 + X_{n,2}^2) \\ k_{c,3} (X_{n,1}^2 + 3X_{n,2}^2) + 2k_{c,4} \cdot X_{n,1} \cdot X_{n,2} \end{bmatrix}$$

From equation (1) and equation (2), it is possible to state a correlation between the projection of each pattern point on the image plane  $X_d$  and its undistorted coordinates (in pixel)  $X_p = [X_{p,1}, X_{p,2}]$  with respect to the image plane coordinate system of the camera:

$$X_{p,1} = f_{c,1} \cdot (X_{d,1} + \alpha_c X_{d,2}) + c_1$$

$$X_{p,2} = f_{c,2} \cdot X_{d,1} + c_2 \quad (3)$$

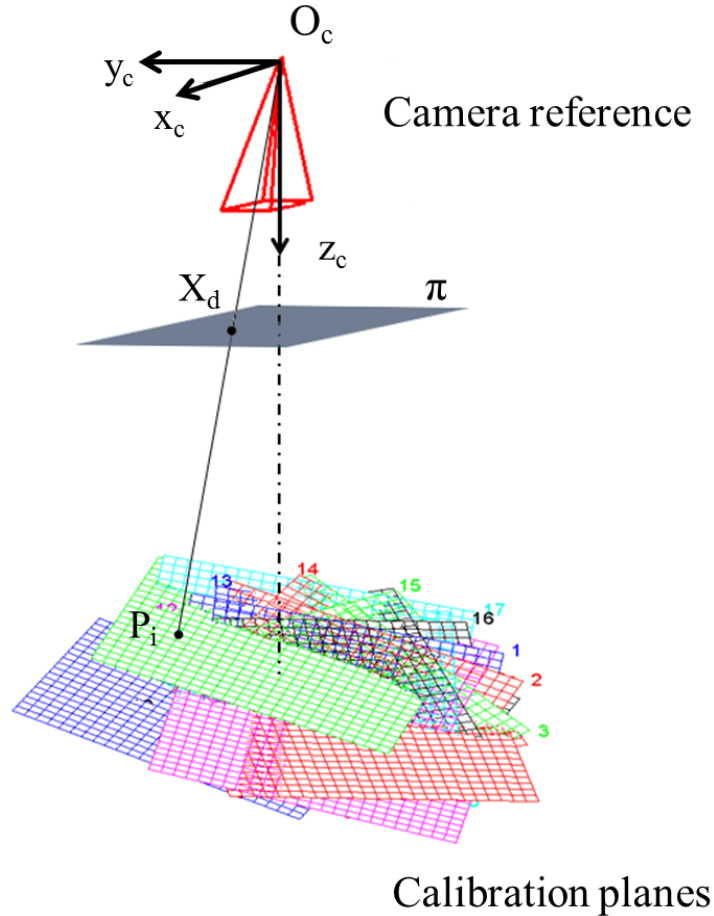
**Figure 8** Camera reference and calibration planes (see online version for colours)

Obviously, calibration procedure is also affected by uncertainties on the assessment of such parameters. In order to calibrate with an error lower than 0.1 mm, the calibration pattern needs to respect the following specifications:

- maximum flatness error equal to 0.1 mm
- maximum error in dimension of the single checker equal to 0.02 mm
- maximum error in absolute position of a single checker on the pattern equal to 0.05 mm.

#### 4.2 *Image processing and edge vectorisation*

Once lens distortions are corrected it is possible to acquire a high-quality geometry image of the working plane where leather patches lie (see Figure 9). First, images are undistorted using equation (3). Then, leather patches edges are detected using a Canny (1986) edge detection method.

**Figure 9** High-quality undistorted image

In the present work, in order to reduce the image background noise, the value of sigma has been set, after a series of experimental attempts, to three while the threshold values have been set equal to, respectively, 0.2 and 0.8. The result of Canny method application to an (undistorted) exemplifying image of two leather patches disposed on the working plane is a binary image (raster data) where edges are represented by unitary thickness outlines with pixel values equal to 1 (white pixels in Figure 10).

Once the leather outlines are determined in pixel coordinates, an appositely devised algorithm has to be implemented in order to vectorise such data. Fitting vectorial curves to point datasets has been widely studied and many techniques, theories and commercial software tools have been developed for fitting ordered (Atieg and Watson, 2003) or unordered point clouds (Furferi et al., 2011b). In the present work, a simple algorithm based on abovementioned literature is implemented. Each image resulting from the application of the Canny operator is scanned row by row, starting from the upper left pixel, until a white pixel is found. When this condition is satisfied, given that the non-zero pixel has coordinates equal to  $X_p$  and that it belongs to a unitary thickness outline, the algorithm performs the following tasks:

- 1 Store the coordinates of  $X_p$  in a matrix  $\chi_p^{(i)}$  (size  $2 \times Ni$ , where  $Ni$  is the number of white connected pixels describing the outline of the  $i^{\text{th}}$  leather patch).
- 2 Explore the  $3 \times 3$  neighbourhood of the pixel  $X_p$  starting from the central upper pixel (i.e., north direction with coordinates  $[X_{p,1} - 1, X_{p,2}]$ ) in clockwise until another white-pixel  $X_p^+$  is detected.
- 3 Store the coordinates of  $X_p^+$  in the matrix  $\chi_p^{(i)}$  and set the pixel with coordinates  $X_p$  equal to 0.
- 4 Set  $X_p = X_p^+$ .

- 5 Iterates Steps 1 to 4 until the whole stripe is ‘walked’. The result of this step is the matrix  $\chi_p^{(i)}$  containing the coordinates of all the white pixels composing the  $i^{\text{th}}$  outline.
- 6 When the first stripe is completed (and its pixels are put equal to 0 in the original image) the algorithm seeks for the next leather patch by scanning the remaining image rows and iterates Steps 1 to 5.

The final result of this procedure is a set of differently sized matrices  $\chi_p^{(i)}$  each one defining the vectorial representation of leather patch outlines.

**Figure 10** Edge detection results (see online version for colours)

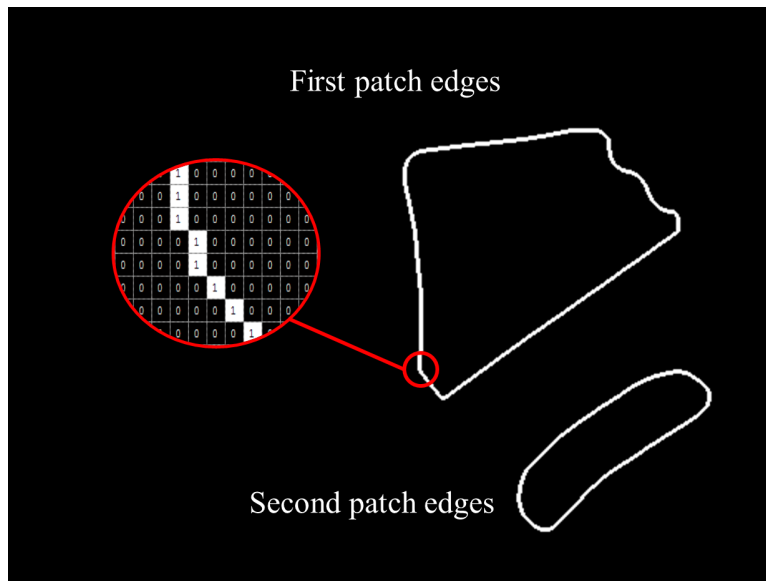

### 4.3 Correspondence between image plane and CNC machine reference system (extrinsic camera calibration)

Once camera parameters are known, a bi-univocal correspondence between the coordinates of each point belonging to matrix  $\chi_p^{(i)}$  and the corresponding ones in the Cartesian pantograph reference system needs to be made explicit in order to guide the painting tool along the patch edges. This may be straightforwardly obtained by means of a further calibration step (extrinsic calibration) consisting of positioning the calibration pattern in a known position with respect to the pantograph (e.g., perfectly lying on the working plane and with its edges coincident with the CNC axes) and include the corresponding image in the calibration set. Let  $\bar{X}_p$  be the vector (size  $2 \times 1$ ) of the coordinates, in pixel, of the generic corner of the checkerboards of the calibration pattern. The relationship between such coordinates and the Cartesian coordinates of the same points in the CNC reference system  $\bar{X}_\phi$  (size  $2 \times 1$ ) is stated by the following (Hartley and Zisserman, 2004) equation:

$$\bar{X}_p = [\mathbf{K}\mathbf{K} \mid \mathbf{0}^{3 \times 1}] \cdot \begin{bmatrix} \mathbf{R}^{3 \times 3} & T^{3 \times 1} \\ \mathbf{0}^{1 \times 3} & 1 \end{bmatrix} \cdot \bar{X}_\phi = \mathbf{P}^{3 \times 4} \cdot \bar{X}_\phi \quad (4)$$

where

- $\mathbf{P}^{3 \times 4}$  is the perspective projection matrix.
- $\mathbf{R}^{3 \times 3}$  and  $T^{3 \times 1}$  are, respectively, the (unknown) rotation matrix and the translation vector stating the relationship between the camera and the CNC reference systems.

Solving equation (4) for all the corners of the checkerboard, using for instance the approach proposed in Heikkilä and Silvén (1997) based on a least square approach, the 12 coefficients of the perspective projection matrix are evaluated. From these coefficients, according to equation (4), it is possible to determine  $\mathbf{R}^{3 \times 3}$  and  $T^{3 \times 1}$  (i.e., the so-called extrinsic parameters) by using single value decomposition and RQ factorisation (Hartley and Zisserman, 2004). However, in our application, obtaining  $\mathbf{R}$  and  $T$  from  $\mathbf{P}$  is not necessary. In fact, once  $\mathbf{P}^{3 \times 4}$  is known, the Cartesian pantograph coordinates matrix  $\chi_p^{(i)}$  (i.e., the coordinates in the CNC reference system of each point defining the  $i^{\text{th}}$  outline) is simply determined by the following equation:

$$\chi_\phi^{(i)} = [\mathbf{P}^{3 \times 4}]^{-1} \cdot \chi_p^{(i)} \quad (5)$$

Depending upon the total length of the patch outline, the generic matrix  $\chi_\phi^{(i)}$  is usually composed by a very large number of elements (polyline segments). In order to reduce the number of segments making up an outline and to make it more ‘regular’, the Douglas-Peucker method (Douglas and Peucker, 1973) is applied. As widely recognised, such a method allows, given a curve composed of line segments, to find a similar curve described by a lower number of segments. Such a simplified curve  $\theta_\phi^{(i)}$  consists of a subset of the points that defined the original curve.

#### 4.4 Thickness compensation

Thanks to the steps of the previously described procedure, the outlines of the leather patches are already expressed in the CNC pantograph reference system. Unfortunately, however, as depicted in Figure 11(a), outlines are derived from central projection acquired images. As a consequence, they cannot be directly used to guide the dyeing tool; in fact leather thickness practically affects accuracy since the apparent outlines detected by images are not coincident with the real ones. In detail, the higher is the leather thickness the greater is the error in determining the actual leather outlines, especially when the leather is positioned far from the point  $C$  obtained by intersecting the vertical line passing through the camera projection centre with the pantograph working plane. In case camera’s optical axis is approximately vertical (i.e., approximately orthogonal to the WP), such an intersection point can be approximated by image centre. In order to reduce this effect, a straightforward method is to place the camera far from the WP [Figure 11(b)]. For this reason, as previously mentioned, in the present work the camera is attached upright to the WP at a distance of 1,400 mm. However, this is not sufficient to guarantee the desired spatial resolution. Thus, an algorithm for compensating the effect of thickness on the determination of leather outlines needs to be developed and used.

**Figure 11** (a) Example of leather patch acquired with central projection: the actual leather outline on the WP (in yellow) differs from the apparent ones derived from the image; (b) Projection error related to projection centre distance from image plane (see online version for colours)

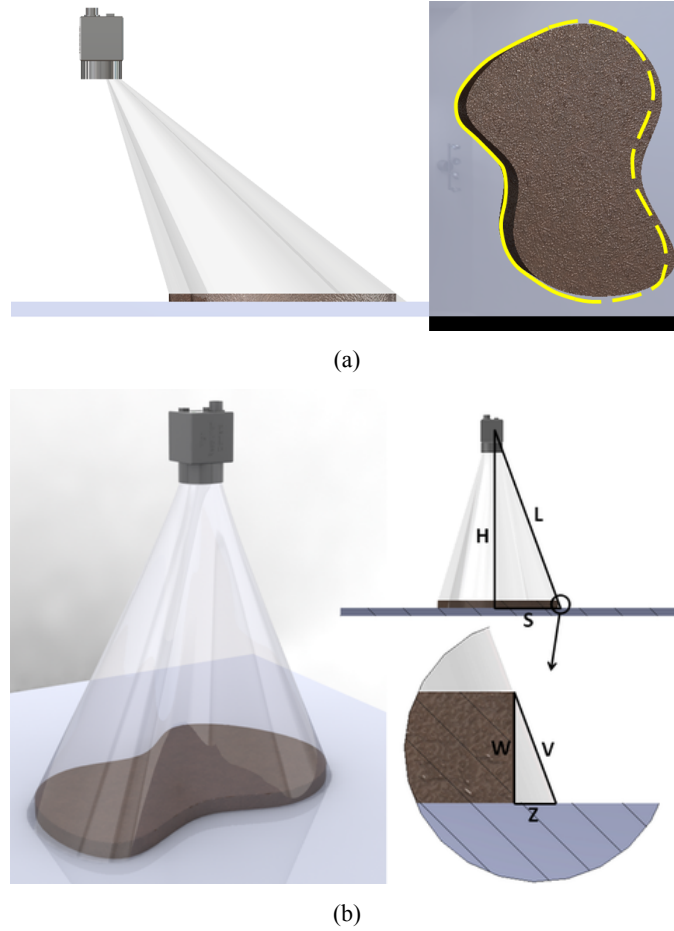

In the present work, the compensation is performed by means of the following procedure:

- 1 For each point  $\theta_\phi^{(i)} = [\theta_{\phi,1}, \theta_{\phi,2}]^{(i)}$  belonging to  $\theta_\phi^{(i)}$  the line  $\lambda$  connecting it with the point  $C$  is traced.
- 2 A point  $k$  with distance  $\epsilon$  (e.g.,  $\epsilon = 0.2$  mm) from  $\theta_\phi^{(i)}$  along  $\lambda$  towards  $C$  is defined.
- 3 If  $k$  falls inside the inner area bounded by the patch outline, the point coordinates  $\theta_\phi^{(i)}$  are updated by applying a translation of modulus  $Z$  along  $\lambda$  towards  $C$ . In detail:

$$Z = W \cdot S / H$$

where:

- $S$  Euclidean distance between  $C$  and  $\theta_\phi^{(i)}$

$H$  distance between the optical centre and the working plane (in the specific case 1,400 mm)

$W$  leather thickness (typically 1 ÷ 2 mm).

4 Otherwise the compensation is not performed.

#### 4.5 Dyeing path retrieval

Once the corrected (thickness compensated) coordinates of all the relevant points defining the leather patches outlines are expressed in the CNC reference frame (i.e., matrices  $\theta_{\phi}^{(i)}$  are computed), the vector outlines are offset to account for dyeing tool felt-tip diameter. As a result, the actual dyeing tool felt-tip path (a path for each leather patch) is determined. However, further steps are required in order to allow the dyeing tool to properly dye the leather edges, especially when more than one patch is placed on the WP. As a matter of facts, in this last case, the dyeing tool is required to ink the outlines moving on the WP without passing above any leather patch. In other words, once a patch is properly inked, the felt-tip has to find the path  $\mathbf{SP}_{i,i+1}$  connecting the  $i^{\text{th}}$  outline to the ‘following’ one  $(i + 1)^{\text{th}}$ , moving in WP areas not ‘occluded’ by other leathers. Moreover, such a path should be the shortest one in order to reduce the idle inking time. In the present work, this problem is solved by using a classical ‘shortest path with obstacle avoidance algorithm’ based on the approach proposed by Zheng et al. (1996). An example of results obtained using the proposed approach is showed in Figure 12; both the leather outlines and the dyeing tool paths ‘connecting’ a leather outline with the following one are depicted in the figure. Note that, thanks to the possibility of using the upper position for the dyeing tool, it would not be necessary to use obstacle avoidance technique and connection path could simply pass over the patches. However, the first solution has been preferred since it prevents possible, sporadic ink drops to fall on the patch surfaces during tool movement.

All the matrices  $\theta_{\phi}^{(i)}$  and the paths  $\mathbf{SP}_{i,i+1}$  are appended into a single cell array defined as follows:

$$\mathbf{TP} = \left[ \mathbf{SP}_{0,1}, \theta_{\phi}^{(1)}, \mathbf{SP}_{1,2}, \theta_{\phi}^{(2)}, \dots, \mathbf{SP}_{m-1,m}, \theta_{\phi}^{(m)}, \mathbf{SP}_{m,0} \right] \quad (6)$$

where

- $\mathbf{SP}_{0,1}$  is the path connecting the felt-tip home position with the first outline.
- $m$  is the number of patches placed on the WP.
- $\mathbf{SP}_{m,0}$  is the path connecting the last patch with the felt-tip home position.

Finally, since the CNC pantograph needs a series of coordinates in order to properly move the dyeing tool along the leather boundaries, the matrix  $\mathbf{TP}$  is translated into an ISO G-code together with all the information (on-off pressure, upper or lower felt-tip position, etc.) required by the dyeing tool.

**Figure 12** Patch outlines (coloured) and connecting dyeing tool paths (black) (see online version for colours)

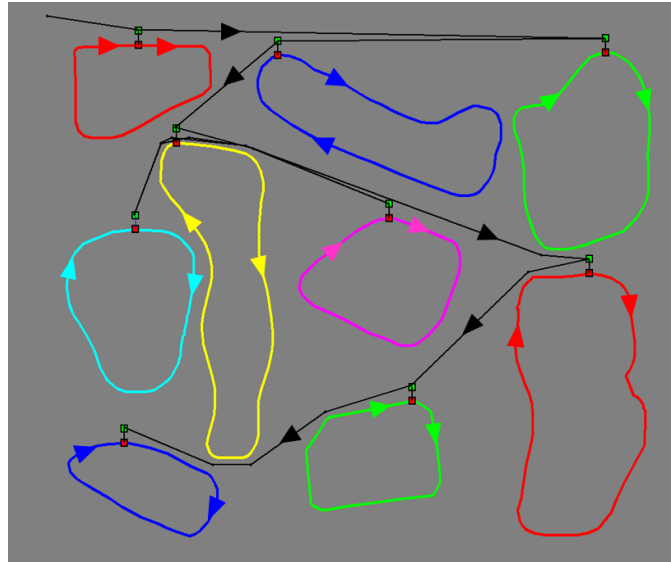

## 5 Results and conclusions

In order to assess the reliability and accuracy of the developed system, an extensive test campaign has been carried out. With the aim of comparing the performance in terms of average dyeing time, the following case studies have been tested:

- rectangular leather patch sized 380 mm × 280 mm
- complex free-form leather patch bounded by a rectangle sized 380 mm × 280 mm
- rectangular leather patch sized 380 mm × 280 mm with a rectangular hole sized 120 mm × 100 mm
- complex free-form leather patch bounded by a rectangle sized 380 mm × 280 mm with a rectangular hole sized 120 mm × 100 mm
- rectangular leather patch sized 100 mm × 50 mm
- complex free-form leather patch bounded by a rectangle sized 100 mm × 50 mm
- rectangular leather patch sized 100 mm × 50 mm with a rectangular hole sized 50 mm × 30 mm
- complex free-form leather patch bounded by a rectangle sized 100 mm × 50 mm with a rectangular hole sized 50 mm × 30 mm.

The patches have been dyed using both the described automatic machine and traditional techniques (performed by skilled operators). In Table 1, the results of the comparison between the performance of the automatic system and the traditional one are presented.

Using the automatic process, the overall dyeing time for all the case studies results lower than to the one obtained with the traditional technique. In case the leather patches are characterised by both outer and inner edges, manual dyeing is dramatically slower than automatic one. In fact, inner edge dyeing requires the operator to 'bring outside' such edges in order to push them close to ink rollers equipping traditional machines, thus resulting in a very complex process. Furthermore, when both inner and outer edges have to be dyed, the operator is required to wait the drying of the first inked edge (inner or outer) because, otherwise the patch risks to get stained due to handling. Quite the reverse, automatic dyeing will not substantially change due to the fact that, once the outlines are detected, the dyeing tool is able to ink the leather patch edges regardless to their inner or outer position in sequence, without the need of idle times due to drying.

**Table 1** Comparison between the performance of the automatic system and the traditional one

<i>Case study</i>	<i>Automatic system dyeing time (s)</i>	<i>Average traditional dyeing time (s)</i>	<i>Time reduction (%)</i>
Rectangular leather patch sized 380 mm × 280 mm	73	78	6.4
Complex free-form leather patch bounded by a rectangle sized 380 mm × 280 mm	114	131	12.9
Rectangular leather patch sized 380 mm × 280 mm with a rectangular hole sized 120 mm × 100 mm	92	128	28.1
Complex free-form leather patch bounded by a rectangle sized 380 mm × 280 mm with a rectangular hole sized 120 mm × 100 mm	135	181	25.4
Rectangular leather patch sized 100 mm × 50 mm	29	30	3.3
Complex free-form leather patch bounded by a rectangle sized 100 mm × 50 mm	36	39	7.6
Rectangular leather patch sized 100 mm × 50 mm with a rectangular hole sized 50 mm × 30 mm	37	78	52.5
Complex free-form leather patch bounded by a rectangle sized 100 mm × 50 mm with a rectangular hole sized 50 mm × 30 mm	45	88	48.8

The machine proves to be effective in automatically dyeing leather edges with uniform ink thickness as showed in Figure 13. In particular, according to the opinion of human experts working in this field, edge dyeing results qualitatively better than the one performed by human operators.

The repeatability of the process has been tested by dyeing a set of leather patches of the same shape, displaced on the WP in different positions and with different orientations and by qualitatively evaluating the quality of the dyed borders. In all the cases, the

borders were inked uniformly regardless to the leather position and orientation on the WP.

**Figure 13** Example of leather contours with uniform ink thickness (see online version for colours)

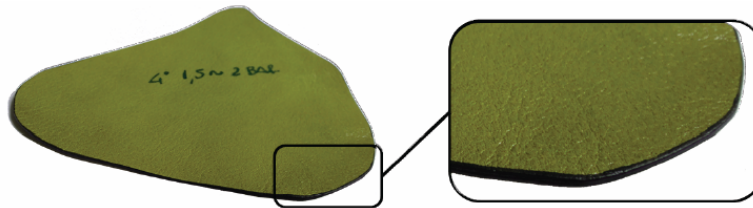

**Table 2** Overall system performance

<i>Parameters</i>	<i>Automatic system real-life performance</i>	<i>Traditional dyeing performance</i>
Finishing quality	Equivalent to the one obtained by a skilled operator	Not always sufficient (often additional repetitions are necessary)
Repeatability	Fully guaranteed	Not guaranteed
Average dyeing time (case studies)	70 s	94 s
Overall accuracy in contour extraction	0.1 mm	Not applicable

Concluding, the overall system performance was satisfactory (see Table 2) and the system proved to be widely applicable.

Future work will be addressed towards the improvement of the patches support system that may require a re-design process, in order to simplify and speed up patches positioning. Another possible improvement could address to issue of possible, though rare, drops falling on the patch upper surface when the dyeing tool passes over to dye a inner edge.

The prototype of the described machine is currently undergoing further, extensive testing, at an important leather manufacturing company in Italy.

## References

- Atieg, A. and Watson, G.A. (2003) 'A class of methods for fitting a curve or surface to data by minimizing the sum of squares of orthogonal distances', *Journal of Computational and Applied Mathematics*, Vol. 158, No. 2, pp.227–296.
- Bennell, J.A., Dowsland, K.A. and Dowsland, W.B. (2001) 'The irregular cutting-stock problem – a new procedure for deriving the no-fit polygon', *Computers and Operations Research*, Vol. 28, No. 3, pp.271–287.
- Bouguet, J.Y. and Perona, P. (1996) 'Camera calibration from points and lines in dual-space geometry', *European Conference on Computer Vision (ECCV)*, Freiburg, Germany, 2–6 June.
- Branca, A., Tafuri, M., Attolico, G. and Distante, A. (1996) 'Automated system for detection and classification of leather defects', *Optical Engineering*, Vol. 35, No. 12, pp.3485–3494.

- Canny, J. (1986) 'A computational approach to edge detection', *IEEE Trans. Pattern Analysis and Machine Intelligence*, Vol. 8, No. 6, pp.679–698.
- Clarke, T.A. and Fryer, J.G. (1998) 'The development of camera calibration methods and models', *Photogrammetric Record*, Vol. 16, No. 91, pp.51–66.
- Douglas, D. and Peucker, T. (1973) 'Algorithms for the reduction of the number of points required to represent a digitized line or its caricature', *The Canadian Cartographer*, Vol. 10, No. 2, pp.112–122.
- Elamvazuthi, I., Kamaruddin, S., Yusoff, M. and Azmi, M.S. (2009) 'Automation of nesting and cutting processes of leather furniture production: a case study', *International Journal of Mechanical and Mechatronics Engineering*, Vol. 9, No. 10, pp.18–24.
- Fuqiang, H., Wen, W. and Zichen, C. (2006) 'Automatic visual inspection for leather manufacture', *Engineering Materials*, Vols. 326–328, No. 1, pp.469–472.
- Furferi, R., Governi, L. and Nunziati, M. (2011a) 'On the performance of several stereo calibration methods and models', *Proceedings of International Conference on Innovative Methods in Product Design, Improve 2011*, San Servolo, Venice, Italy, 15–17 June, pp.416–422.
- Furferi, R., Governi, L., Palai, M. and Volpe, Y. (2011b) 'Multiple incident splines (MISs) algorithm for topological reconstruction of 2D unordered point clouds', *International Journal of Mathematics and Computers in Simulation*, Vol. 5, No. 2, pp.171–179.
- Gomes, A.M. and Oliveira, J.F. (2002) 'A 2-exchange heuristic for nesting problems', *European Journal of Operational Research*, Vol. 141, No. 2, pp.359–370.
- Hartley, R.I. and Zisserman, A. (2004) *Multiple View Geometry in Computer Vision*, 2nd ed., March, Cambridge University Press, Cambridge, UK.
- Heikkilä, J. and Silvén, O. (1997) 'A four-step camera calibration procedure with implicit image correction', *IEEE Conference on Computer Vision and Pattern Recognition (CVPR'97)*, San Juan (Porto Rico), 17–19 June, pp.1106–1112.
- Hoang, K. and Nachimuthu, A. (1996) 'Image processing techniques for leather hide ranking in the footwear industry', *Machine Vision and Applications*, Vol. 9, No. 3, pp.119–129.
- Hoang, K., Wen, W., Nachimuthu, A. and Jiang, X.L. (1997) 'Achieving automation in leather surface inspection', *Computers in Industry*, Vol. 34, No. 1, pp.43–54.
- Hopper, E. and Turton, B.C.H. (2001) 'A review of the application of metaheuristic algorithms to 2D strip nesting problems', *Artificial Intelligence Review*, Vol. 16, No. 4, pp.257–300.
- Koike (2010) [online] <http://www.koike.com/>.
- Liverani, A., Leali, F. and Pellicciari, M. (2010) 'Real-time 3D features reconstruction through monocular vision', *International Journal on Interactive Design and Manufacturing*, Vol. 4, No. 2, pp.103–112.
- Maurtua, I., Aitor, I. and Tellaeche, A. (2012) 'Robotics for the benefit of footwear industry', *Intelligent Robotics and Applications, Lecture Notes in Computer Science*, Vol. 7507, pp.235–244, Springer, Heidelberg, Germany.
- Nemec, B. and Zlajpah, L. (2008) 'Shoe grinding cell using virtual mechanism approach', *Fifth International Conference on Informatics in Control, Automation and Robotics*, Funchal, Madeira, Portugal, 11–15 May, Vol. 1,.
- Neto, M.M., Vendrametto, O. and Fusco, J.P.A. (2005) 'Automated system for leather inspection', *The Machine Vision, Emerging Solutions for Future Manufacturing Systems*, Vol. 159, pp.387–396, Springer, New York, USA.
- Pistori, H.A., Paraguassu, W.A., Martins, P.S., Conti, M.P., Pereira, M.A. and Jacinto, M.A. (2007) 'Defect detection in raw hide and wet blue leather', *Proceedings of the International Symposium CompIMAGE 2007*, pp.355–360.
- Rosenberg, S.E. and Brockton, M. (1939) 'Mechanism for edge staining leather and the like', Patent US2170218(A) [online] <http://www.google.com/patents/US2170218> (accessed 11/01/2013).

- Weng, J., Cohen, P. and Herniou, M. (1992) 'Camera calibration with distortion models and accuracy evaluation', *IEEE Transactions on Pattern Analysis and Machine Intelligence*, Vol. 14, No. 10, pp.965–981.
- Whitwell, G. (2004) *Novel Heuristic and Metaheuristic Approaches to Cutting and Packing*, PhD Thesis, School of Computer Science and Information Technology, University of Nottingham, UK.
- Wu, T.H., Chen, J.F., Low, C. and Tang, P.T. (2003) 'Nesting of two dimensional parts in multiple plates using hybrid algorithm', *International Journal of Production Research*, Vol. 41, No. 16, pp.3883–3900.
- Yeh, C. and Perng, D.B. (2001) 'Establishing a demerit count reference standard for the classification and grading of leather hides', *International Journal of Advanced Manufacturing Technology*, Vol. 18, No. 10, pp.731–738.
- Zheng, S.Q., Lim, J.S. and Iyengar, S.S. (1996) 'Finding obstacle-avoiding shortest paths using implicit connection graphs', *Computer-Aided Design of Integrated Circuits and Systems, IEEE Transactions*, Vol. 15, No. 1, pp.103–110.