

Review

# What Is the Current State of Sustainability in the Decorative Electroplating Industry? A Close Look at New Practices and Advances

Walter Giurlani <sup>1,2</sup>, Giulio Pappaianni <sup>1</sup>, Fabio Biffoli <sup>1</sup>, Elena Mariani <sup>1</sup>, Marco Bonechi <sup>1,2</sup>, Leonardo Giliberti <sup>3</sup>, Margherita Tufarelli <sup>3</sup>, Paolo Franzo <sup>3</sup>, Elisabetta Cianfanelli <sup>3</sup> and Massimo Innocenti <sup>1,2,4,5,\*</sup>

<sup>1</sup> Department of Chemistry "Ugo Schiff", University of Florence, Via della Lastruccia, 3, 50019 Sesto Fiorentino, FI, Italy; elena.mariani@unifi.it (E.M.); marco.bonechi@unifi.it (M.B.);

<sup>2</sup> National Interuniversity Consortium of Materials Science and Technology (INSTM), Via G. Giusti 9, 50121 Firenze, FI, Italy

<sup>3</sup> Design Campus, University of Florence, Via Sandro Pertini, 93, 50041 Calenzano, FI, Italy

<sup>4</sup> Institute of Chemistry of Organometallic Compounds (CNR-ICOMM), National Research Council (CNR), Via Madonna del Piano 10, 50019 Sesto Fiorentino, FI, Italy

<sup>5</sup> Center for Colloid and Surface Science (CSGI), Via della Lastruccia 3, 50019 Sesto Fiorentino, FI, Italy

\* Correspondence: m.innocenti@unifi.it

**Abstract:** Electroplating is a key process in many industrial fields such as automotive, electronics and decorative applications; this process makes it possible to provide new properties to substrate materials such as corrosion resistance, hardness and aesthetic value. Nonetheless, electroplating is considered one of the most non-sustainable industries related to the manufacturing sector, from both an environmental and a social point of view. With the approaching deadlines set by the United Nations for the 2030 Agenda, electroplating companies have started a trend of innovating their production processes with a focus on sustainability, acting on several fronts: performing simulations to predict criticalities and optimize working procedures, reducing the material used and recovering it from processing water. The purpose of this communication is to highlight the state of the art of sustainable practices peculiar to the electroplating industry, critically analyzing ongoing challenges to achieve and exceed the targets set by regulatory agencies. Both atomistic and multiphysics simulations will be analyzed as powerful tools to design both new sustainable formulations and items; then, the problem of metal dispersion will be discussed, evaluating different industrial approaches; finally, the focus will be shifted towards the general procedures to recover metal from wastewater.

**Keywords:** sustainability; waste reduction; computational methods; waste recovery; electroplating industry

**Citation:** Giurlani, W.; Pappaianni, G.; Biffoli, F.; Mariani, E.; Bonechi, M.; Giliberti, L.; Tufarelli, M.; Franzo, P.; Cianfanelli, E.; Innocenti, M. What Is the Current State of Sustainability in the Decorative Electroplating Industry? A Close Look at New Practices and Advances. *Sustainability* **2024**, *16*, 5821. <https://doi.org/10.3390/su16135821>

Academic Editor: Kaan Kalkan

Received: 20 May 2024

Revised: 28 June 2024

Accepted: 3 July 2024

Published: 8 July 2024



**Copyright:** © 2024 by the authors. Licensee MDPI, Basel, Switzerland. This article is an open access article distributed under the terms and conditions of the Creative Commons Attribution (CC BY) license (<https://creativecommons.org/licenses/by/4.0/>).

## 1. Introduction

The process of electroplating is vital in many industries that produce modern aerospace materials and electronics [1–3], heavy equipment, cars, decoration and fashion [4–6]. The increasing focus on sustainability within several areas has also seen a critical re-evaluation of electrodeposition practices within the context of the United Nations' sustainable development goals (SDGs) [7]. The main critical items regarding the plating industry lie within the environmental sector, from production to disposal, and health within the workplace [8,9]. Electroplating, in many instances, involves hazardous agents such as cyanides, chromium and nickel, which adversely affect the environment and human beings [10]. Some of the traditional processes consume a great deal of energy, thus contributing to the carbon footprint of the industry [11,12]. The production of galvanized items often involves the extensive use of scarce materials such as gold and palladium, which

have challenges associated with their mining processes. The issue of toxic manufacturing waste and how to dispose of it is a major environmental concern, involving high costs and risks.

These are well-known problems that drive research in this area; major themes include finding ways to replace toxic compounds with less hazardous alternatives. For instance, cyanide-free [13–17] electroplating baths and nickel-free processes are among the ways of reducing such risks. Others are the use of innovative alloys that minimize precious materials, as well as solutions seeking to ensure the needed performance whilst employing small quantities of costly metals and to carry out cleaner fabrication, minimizing the production of toxic wastes. Additional measures include encouraging recycling efforts to regain valuable components from electroplating waste, expansion of investment into more energy-efficient technology in processes [18–20] and the use of pulsed or modulated currents to enhance deposition efficiency [21–23].

The issue is complicated and linked almost exclusively to the ecological problems such as pollution relating to the industry of electroplating. However, it is important to recall that sustainability is a wider and more complex notion. Economic and social elements frequently remain disregarded as attention is primarily directed toward ecological issues. Therefore, corporate strategies embrace green topics that are tied to the communities where the corporations operate and reflect on economic considerations as well. However, only through a single vision that takes into consideration these needs can the electroplating industry and all the others respond to these challenges equitably and responsibly.

To make the industrial process more sustainable, there is a need to train operators in sustainable practices and environmental awareness with a view that such procedures will take root on the industrial scale. Collaboration between industries and research institutions is essential to set up sustainable guidelines for the electroplating sector as well as share the benchmarks. Furthermore, government-backed policies and incentives should be established for promoting cleaner technology, sustainable R&D, etc., within industry. Finally, investors should be encouraged in the development of green technologies as well as research efforts towards sustainability and, ultimately, the adoption of greener processes.

Mathematical models have been developed as well as artificial intelligence methods used to optimize processes and reduce the effect on the environment as part of addressing sustainability problems [4,24,25]. Some of them consist of activity such as “Pollution prevention” (P2) which has played an integral role in the development and implementation of technologies designed to prevent the amount of waste generated at a facility. The P2 approach is extended to “Profitable P2” (P3), which seeks economic benefits with environmental reduction [26], and even “Cooperative P3” (CP3) for industrial areas to aid in decision making toward sustainable development [27].

Song [28], in 2016, explained the prevalent sustainability measurement systems but stressed the need to generate a specific system of metrics for evaluating the sustainability performance of the electroplating industry. These comprise economic sustainability indicators, environmental sustainability indicators and social sustainability indicators. These indicators focus on issues that include profit, value addition, energy, material usage, water consumption and emissions, among many other factors.

In 2015, the United Nations stated 17 SDGs for development of the world’s agenda in elimination of global challenges, improvement of the living standards of people and protection of the planet until 2030. The 17 SDGs are a universal call for an end to poverty and a beginning to prosperity, health and life on earth. The electroplating industry is also based on a thorough critical analysis of the SDGs as a starting point to identify directions for improving sustainability.

Several SDGs are closely related to electrodeposition in a direct perspective. One such example could be SDG 9 (industry, innovation, and infrastructure), which could advance efficiency and lessen environmental effects with such technologies as electrodeposition. This is why modern electrodeposition technologies have been adopted as an element of innovations that enhance efficiency and reduce environmental pollution. The

development of more sustainable processes through research is key for the industry's growth. New materials and novel electroplating processes can also be utilized to the benefit of the decorative sector and, to a certain extent, of the technical sector, supplying eco-aesthetic solutions. Simultaneously, attention to responsible utilization of chemical resources that follows SDG 12 becomes vital. Reducing the content of precious metals in electroplating processes is an important contributor to the more responsible use of resources and answers consumers' demand for more sustainable products. The development of cyanide- and nickel-free electrolytes is one step towards a safer and more sustainable operation process. The strategy can achieve SDG 7 (clean and accessible energy) due to the implementation of low-energy-consumption and ambient-temperature processes that lead to lower environmental impacts associated with energy consumption; it is related to SDG 13 (climate action) as well. Water resource management and sustainability in the context of SDG 6 (clean water and sanitation), where efforts are taken for the reduction of water consumption in electroplating. Investment in research and development of the electroplating industry by innovative methods can lead to improved economic growth and skilled jobs according to SDG 8 (decent work and economic growth). There are other issues relating to employment and economic development, even in the artisanal contexts.

Sustainability of the electroplating system can be regarded as an integration of waste minimization, production enhancement and social sustainability [28]. Environmental impact and health burdens can be effectively reduced by waste reduction. In addition, waste reduction refers to chemicals, sludge, water and energy. Social sustainability involves looking at issues that relate to customer satisfaction, employee satisfaction and local community satisfaction.

Economic globalization has put a strain on the electroplating industry [29–31]. Most electroplating companies are usually working at a loss, as well as using rather obsolete technologies. Moreover, the industry is one of the most polluted among the manufacturing industries. The sustainability of a production is also the consequence of the efficiency of the process, management and workflows. There are already existing management methods and new ones are being developed constantly to meet this goal. Lean production and manufacturing are methodologies which are designed for the improvement of efficiency, the reduction of waste and the enhancement of the quality in the production processes. The idea of lean production was born in the 1950s with the Toyota Production System and was greatly developed by Taiichi Ohno at Toyota, thus forming the Toyota Production System (TPS) [32]. This system is mainly centered on the reduction of waste and the improvement of the processes to attain the total quality. The production of any product must be sustainable, and this means the processes, management and workflows must be streamlined. The fundamental elements of lean manufacturing are the 5S method (Sort, Set in order, Shine, Standardize, Sustain) for workplace organization, Just-In-Time (JIT) production to cut down on inventory and produce only when required and Poka-Yoke devices to prevent errors. The lean model, which is based on Eastern philosophy, then spread globally, highlights the idea of production flow and takt time, which is the main feature of its approach.

Six Sigma, a quality management methodology that was created by Motorola in the 1980s, is another system that aims at the improvement of product quality by the reduction of the process defects [33]. Six Sigma uses a number of statistical tools to minimize variability and reach the point of perfection, that is, few defects per million opportunities. The methodology follows two main approaches: DMAIC (Define, Measure, Analyze, Improve, Control) [34,35] for the enhancement of the existing processes and DMADV (Define, Measure, Analyze, Design, Verify) [36,37] for the design of new processes or products. It is a highly analytical and numerical model, which is basically a data- and statistics-based model that aims at making improvements.

The Lean Six Sigma is the method that combines the principles of the lean manufacturing and Six Sigma [38]. This combination of theory and practice is designed to cut down waste and process variability; thus, the productivity will be increased, and the quality will

be improved. The Lean Six Sigma methodology employs lean tools to make the processes efficient and Six Sigma tools to guarantee the process control and quality enhancement.

In decorative electroplating, lean principles could be used to make the process of work more efficient, reduce waste and enhance the quality of the plated products [39,40]. The 5S method could be used to organize the workspace, so that the tools and materials are within easy reach, thus, it will reduce the time spent searching for them and minimize the delays. JIT could be applied to the inventory management; thus, the only amount of the raw materials is available when needed, thus, reducing the storage costs and the waste. The Poka-Yoke devices could be used to avoid the usual errors in the plating process, for example, wrong chemical mixtures or the improper handling of materials.

Six Sigma methodologies, mostly DMAIC, could be used in the electroplating process to discover and eliminate the causes of defects; thus, each step of the process can be improved for high quality [41]. To illustrate, by finding out the thickness and the uniformity of the plating, the causes of the variations and the ways of improvement can be investigated, and the process can be made more consistent and of higher quality.

The Lean Six Sigma concept has given powerful tools to improve the efficiency, cut the waste and to enhance the quality in different industries including decorative electroplating and fashion [42]. These methods create a culture of continuous growth, which in turn makes the organizations more competitive and customer oriented.

In this manuscript we will discuss in detail some newly established eco-friendly practices in this industry that may benefit the environment, human beings and society. The aim will be to present a vision for a future in which electrodeposition does not only respond to the technological requirements but goes further towards a more sustainable environment through case studies and analysis of challenges faced today. Several computations techniques for predicting new formulations without using harmful substances are described specifically. Commercial systems for the better homogeneity and compaction of galvanic deposits to cut down on the amount of material being used will be discussed with some case studies. In the last, treatment and disposal or recovery of wastewater metals for the environmental protection, as well as for the economic benefit of recycling valuable metals, will be analyzed.

## 2. Computational Methods

Although many attempts to improve the sustainability [43] of an electroplating plant by optimizing the whole process have been made by companies in the decorative industry, the R&D process for the optimization of the numerous variables is still based on a trial-and-error method. In this scenario, *in silico* procedures are trending, as the cut-and-try approach could be translated from the production plant to a chip, or even avoided by introducing predictions and systematic studies. Furthermore, *in silico* approaches are in line with the sustainable model proposed in Agenda 2030 by United Nations [44]. Specifically, three sustainable developments goals (SDG) are achievable: 3 (good health and well-being), 8 (decent work and economic growth) and 10 (reduced inequalities). SDG 3 is related to the reduction and, possibly, the elimination of hazards in the R&D phase; moreover the prediction and development of new green processes is fundamental to ensure a healthy working environment in production departments. Shifting the workplace from a laboratory to a computer ensures that people with motor-related impairments can express their full creative potential, as they are no longer limited by structural barriers, accomplishing SDGs 8 and 10. To model an electrochemical process, it is helpful to distinguish two different families of simulations, distinguished by their scale: atomistic simulations [45] and multiphysics simulations [46]. The latter are divided further in *ab initio* and classical approaches, the first one based on quantummechanic calculations and the second one on classical mechanics.

## 2.1. Atomistic Simulations

Atomistic simulations are helpful to develop new sustainable additives or to understand how the different components of a bath formulation, such as additives and ions [47], interact with each other [48], but they are not yet suitable for industrial practice as they are typically limited to university facilities due to the need for high-performance computers [49] and, above all, an in-depth knowledge of all the chemical and physical processes that are involved. As stated before, molecular systems can be modeled by molecular mechanics (MM), quantum mechanics (QM) or a mix of both (QM/MM). In MM, molecules are considered in terms of bonded atoms with the bond described as a spring. MM is based on the three principles of Newtonian mechanics, with the equation of motion described by the second principle. In MM, it is convenient to describe the system in terms of a Hamiltonian ( $H_{MM}$ ); if the generalized coordinates are not explicitly time-dependent and if the forces are derivable from a conservative potential ( $V_{MM}$ ), it can be represented as the sum of a kinetic term  $K_{MM}$  and  $V_{MM}$  (Equation (1)).

$$H_{MM} = K_{MM} + V_{MM} \quad (1)$$

The union of the form of the functional and parameters [50] is known by the name of Force Field. There are many of them specialized in reproducing different situations, e.g., to simulate organic molecules and ligands, the GAFF protocol family is recommended [51–53]. Despite that, the basic form of a potential functional is expressed in Equation (2) with  $V_{bounded}$  taking into account covalent terms as bond stretching ( $V_{bonding}$ ), bending and dihedral torsions ( $V_{torsion}$ ) and  $V_{non-bounded}$  representing non-covalent terms as electrostatic ( $V_{Coulombic}$ ) and Van der Waals ( $V_{vdW}$ ) interactions.

$$\begin{aligned} V_{MM} &= V_{bounded} + V_{non-bounded} \\ V_{bounded} &= V_{stretching} + V_{bonding} + V_{torsion} \\ V_{non-bounded} &= V_{Coulombic} + V_{vdW} \end{aligned} \quad (2)$$

MM, depending on classical mechanics, has a much lower computational cost than QM; although it does not explicitly take electrons into account and thus cannot simulate important phenomena such as bond formation and cleavage, it is widely used to simulate large systems and physical adsorption of organic molecules on metallic surfaces. MM has been already successfully employed to study adsorption mechanism of Ni-Ammonium complexes on Ni nanocones [54] and the adsorption of bath's impurities (such as Zn) in Ni electroplating baths [55]. Furthermore, MM has been successfully used in the screening of pyrophosphate copper bath additives [56].

On the other hand, QM describes molecules in terms of electrons and nuclei with no references to bonds. The basis of QM is the Schrödinger equation, which is reported, in the time-independent form, in Equation (3), where  $\hat{H}_{QM}$  is the QM Hamiltonian operator,  $E$  is the energy of the system and  $\Psi$  is the wavefunction [57].

$$\hat{H}_{QM}\Psi = E\Psi \quad (3)$$

To solve Equation (3), there are two families of methods: one based on wavefunctions as in the Hartree–Fock and post-Hartree–Fock methods (e.g., Møller–Plesset, Configuration Interaction, Coupled Cluster) and one based on the density functional theory (DFT). Despite post-HF methods have been proven to give better results, going under the chemical accuracy [58], their computational cost makes it prohibitively expensive to study typical electroplating systems composed of many atoms and transition metals. Hence, DFT and hybrid DFT methods are the preferred options for the study of electrochemical systems given the compromise between accuracy and computational cost. Ab initio calculations have been employed to study the interaction of commercial additives [59] for copper electroplating with a Cu (111) surface [60] and to study the efficiency of novel suppressors for Cu acid baths [61].

To simulate large chemical systems such as electrolyte baths for decorative application, it is possible to adopt a QM/MM approach [62] defining an active space that is going

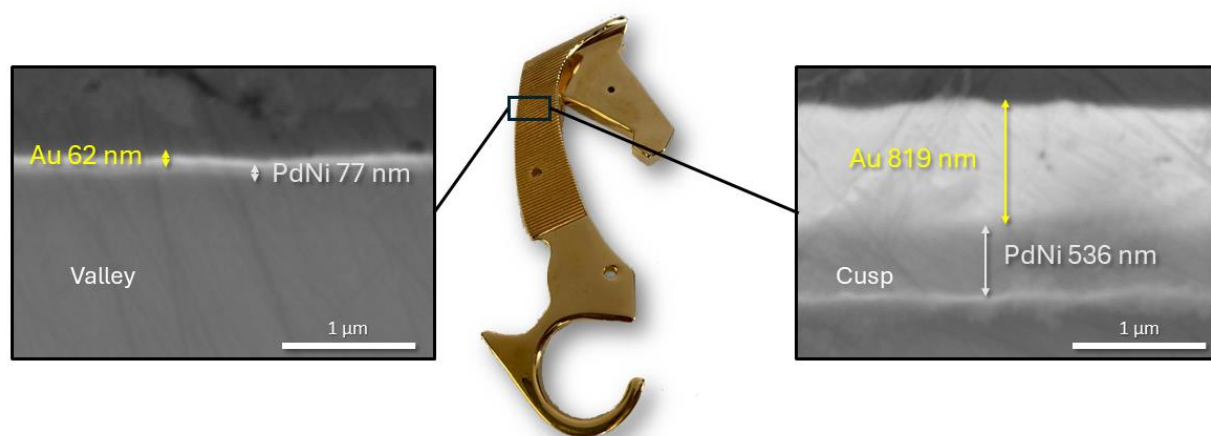
to be treated QM. Consequently, the QM/MM Hamiltonian can be defined as in Equation (4) where  $\hat{H}_{QM}$  and  $\hat{H}_{MM}$  are, respectively, the QM and the MM Hamiltonians and  $\hat{H}_{QM-MM}$  is the operator taking into account the interactions between the MM system and the QM active space [63].

$$\hat{H}_{QM/MM} = \hat{H}_{QM} + \hat{H}_{MM} + \hat{H}_{QM-MM} \quad (4)$$

This methodology makes it possible to perform cost efficient simulations, even on big systems, as it is capable of combining the speed of MM with the accurate description of phenomena by QM. However, this is only possible through in-depth knowledge of the system, so as effectively define the active space. QM/MM approaches are rarely used to characterize electrochemical systems but they are widely used to characterize active sites of metalloproteins [64]; nonetheless, the methodologies can be transferred to electrodeposition as well.

## 2.2. Multiphysics Simulations

Multiphysics approaches, based on fluid dynamics simulations, are a reliable tool to understand how the design of manufacts and anodes can influence the thickness distribution due an inhomogeneous current density distribution, even using ordinary computers. Especially in the decorative field, where the lack of sustainability is also related to a compartmentalization of entities involved (e.g., artistic direction, metalworking company and electroplating facility), the geometry of artifacts and goods is not designed to minimize the thickness dispersion, presenting cusps and valleys where the charge density changes dramatically [65]. An example of a complex accessory can be appreciated in Figure 1, it was electroplated following the industrial standard for an hypoallergenic cycle (ISO 1811 [66]), made of Copper/White Bronze/Palladium-Nickel/Gold, where copper is used as leveler and brightener layer [67], while white bronze and palladium are used as an anticorrosion layer [68] and a barrier layer against intermetallic diffusion [69].



**Figure 1.** Fashion accessories presenting a complex geometry made of many cusps and valleys to represent a horse crest; the difference in deposited thicknesses of precious metals on a cusp and a valley observed in a cross section of the sample by a scanning electron microscopy (SEM) analysis.

The effect of the geometry in current distribution is also depicted in Figure 1, where, thanks to scanning electron microscopy (SEM) imaging, carried out at 20 kV, the difference in the thickness of layers is clearly influenced by the shape of the object. A simple but effective simulation of the current density distribution along the cathode and its influence over the thickness dispersion can be achieved by simply considering the primary current distribution [70] (i.e., the current distribution, which depends only on the gradient of the electric potential and the resistivity of the medium [71]). To better reproduce an electrolysis, including secondary (i.e., the current distribution that consider charge-transfer

processes and mass transport at electrodes [72]) and tertiary currents (i.e., the current distribution that mind diffusion, migration and convection of charged and uncharged species [73]), the system can be modelled with a computational fluid dynamics approach and described as a systems of differential equations and boundary conditions [74] that were extensively discussed by Kauffman [75] in 2020 (the results leading to current and thickness distributions over an irregular shape are reported in Figure 2). Considering the electrolyte as an incompressible fluid, the hydrodynamics is governed by the conservation of mass and the conservation of momentum as reflected in the Navier–Stokes equations, Equations (5) and (6), with  $\mathbf{u}$  representing the fluid velocity,  $P$  the fluid pressure,  $\mu$  the dynamic viscosity,  $\rho$  the fluid density and  $\mathbf{N}$  the resultant of the external forces acting on the fluid. The Navier–Stokes equations are usually solved by tested and robust algorithms such as SIMPLE [76], PISO [77] and PIMPLE [78].

$$\nabla \cdot \mathbf{u} = 0 \quad (5)$$

$$\frac{\partial \mathbf{u}}{\partial t} + \nabla \cdot (\mathbf{u} \times \mathbf{u}) - \nabla \cdot (\mu \nabla \mathbf{u}) = -\frac{1}{\rho} \nabla P + \mathbf{N} \quad (6)$$

The electroneutrality of the electrolyte is fixed with Equation (7) and charge transport for the  $i$ th species is taken into account by the Nernst–Planck equation, Equation (8), with  $\mathbf{J}$  representing ion flux within the fluid,  $D$  the diffusion coefficient of the species,  $c_i$  the concentration,  $n_i$  the valence electrons,  $R$  the ideal gas constant,  $F$  the Faraday constant,  $T$  the temperature and  $\phi$  the electric potential.

$$\sum n_i c_i = 0 \quad (7)$$

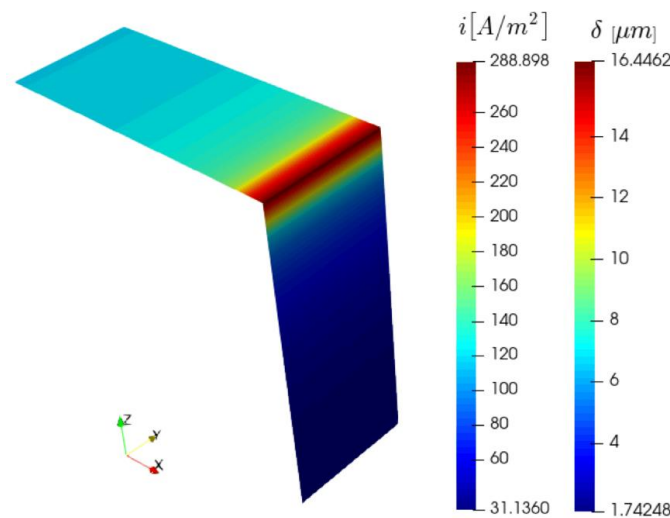
$$\mathbf{J}_i = -D_i \cdot \nabla c_i - \frac{D_i n_i F}{RT} c_i \cdot \nabla \phi + c_i \cdot \mathbf{u} \quad (8)$$

The mass transport at both cathode and anode is considered in the Butler–Volmer equation, Equation (9) ( $i$  is the current density,  $i_0$  is the exchange current density,  $C^{bulk}$  is the bulk concentration of the species in the fluid and  $C(0, t)$  is the concentration at the electrode surface where the subscript indicates the species involved in oxidation ( $O$ ) and in reduction ( $R$ );  $\eta$  is the overpotential and  $\alpha$  and  $\beta$  are respectively the symmetry anodic/cathodic barrier factors depending on the thermodynamic of the system [79]).

$$i = i_0 \left[ \left( \frac{C_O(0, t)}{C_O^{bulk}} \right) e^{-\alpha n F \eta \frac{1}{T}} - \left( \frac{C_R(0, t)}{C_R^{bulk}} \right) e^{\beta n F \eta \frac{1}{T}} \right] \quad (9)$$

The thickness ( $\tau$ ) distribution onto the cathode is evaluated by imposing at the cathode Faraday’s law for electrolysis (Equation (10)) as a boundary condition, considering  $t$  the deposition time;  $i$  the current at the electrode (evaluated with Equation (9)) and  $M_w$  and  $\rho_m$  the molecular mass and density, respectively.

$$\frac{\partial \tau}{\partial t} = i \frac{M_w}{\rho_m n F} \quad (10)$$



**Figure 2.** Current density ( $i$ ) distribution and thickness distribution ( $\delta$ ) over a cathode of irregular shape obtained with CFD simulations by Kauffman [75] (image under Creative Commons CC BY 4.0 license, all rights and intellectual property belong to the authors; for more information, see <https://creativecommons.org/licenses/by/4.0> accessed on 15 April 2024).

In multiphysics simulations, the previously illustrated equations are solved according to the finite element method (FEM) [80], a numerical approach already extensively used in the engineering field to discretize continuous problems [81–83]. In FEM approach the input geometry (i.e., the electrochemical cell) is divided into finite elements, building a mesh. Differential equations are solved in the integral form, discretizing integrals in a summatory over finite elements where shape functions are defined [84]. Multiphysics simulations can be easily implemented in the industrial manufacturing workflow for example using the commercial software COMSOL 6.2 [85], directly importing the CAD designs of decorative accessories. An example of modelling an industrial process of electroforming with it was proposed by Andreou [86] in 2022. The opensource alternative is represented by the OpenFOAM framework [87]: it allows complete personalization of the system but its use is not immediate as it requires programming and scripting knowledge. In 2020 Kauffman [75] proposed and tested an algorithm inside the OpenFOAM environment that successfully described the electrodeposition of copper, reproducing effectively the thickness distribution over a cuspidated cathode. In 2023, Huang [88], still in the OpenFOAM environment, made a whole framework for electrochemical processes and electrolyte flow capable of accounting for different species, including external forces over the electrolyte and the influence of a magnetic field on the electrodeposition process. Connecting designers, metalworking engineers and chemists through multiphysics simulations it will be possible to produce goods with sustainable geometries reducing drastically the waste of precious metals. Each of these three figures has a fundamental place in this challenge: designers have the task of creating new geometries and providing CAD models; engineers must validate the mechanical feasibility of geometries; chemists must perform simulations to find the optimal parameters for it, such as the exchange current, the symmetry factors and the deposition potential, and chemists also need to validate the results of simulations through experimental counterparts determining the thickness of deposited metals through non-destructive methods, such as X-ray fluorescence spectroscopy (XRF) [70]. The whole production process can be fully optimized only if all the data from these three figures of the fashion industry can be crossed and elaborated in order to obtain the better results. Hence, AI-based technologies [89] can be the key elaborate this multitude of correlated aspects. Specifically, to help the artists to reimagine fashion items, a generative design [90,91] approach could take the full advantages of the thickness distributions obtained from multiphysics simulations and find an alternative geometry with the constrain



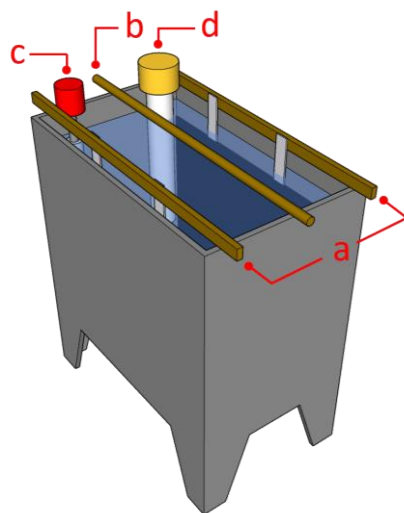
minimize the current distribution. Additionally, this novel production scheme needs to be iterative, alternating multiphysics simulations with generative design, to achieve the lowest metal dispersion possible.

### 3. Deposition Systems

Obtaining homogeneous electrochemical deposits is an issue of absolute importance, especially in the field of the high-fashion industry, where precious metals are often used. Indeed, even a low percentage reduction in consumption leads to a great advantage for the overall process [92].

Having a low standard deviation in the metal deposit allows a smaller amount of material to be used, as the required minimum thickness values can be achieved with less dispersion in the obtained coating, thus operating with reduced costs and less operating time. This leads to clear advantages for the environment sustainability of the entire production process and for the competitiveness and profitability of the manufacturing company. The thickness of the deposits obtained from present electroplating production is uneven because it is strongly influenced by the shape of the treated objects and the current distribution [93,94].

In this work, we therefore chose to conduct a benchmark study of the systems adopted by companies to control the distribution of thicknesses in the case of a precious metal finishing, evaluating the effect of different state of the art industrial engineering solutions. The thickness distribution of gold deposition within the electroplating rack, obtained using the standard parallel anode configuration, was taken as the reference. It was compared with two devices operating on direct current (DC) designed to overcome thickness inhomogeneities and a system operating on pulsed current (PC). The depositions were performed in a typical electroplating tank (Figure 3).



**Figure 3.** A 500 L electroplating tank containing (a) two anode bars, one for each side, to which the MMO anodes are connected; (b) a central cathodic bar, where the rack is attached; (c) a float to control the level and temperature of the solution; (d) a heating element for heating the solution.

All the samples were kindly electroplated and provided by Lotti Srl (Signa, FI, Italy), Gruppo Materia Firenze (Scandicci, FI, Italy) and Eco-Tech Finish Srl (Arezzo, AR, Italy), on their industrial production lines according to the internal standard production process. The specifications of the materials and methods used are given in Supplementary S1.

#### 3.1. DC Deposition Systems

The case study carried out on optimization systems operating on DC was performed on a gold deposit, electrodeposited by means of the commercial “Bluclad 8693”

(Calenzano, FI, Italy) electroplating solution. The performance of a classical system operating with common mixed metal oxide (MMO) anodes was compared with that of the commercial systems Italfimet (Monte San Savino, AR, Italy) “Raddrizzatorre Anti Effetto Punta” (RAEP) and Luxury Brands Technologies (LBT) (Calenzano, FI, Italy) “Homogeneous Coating System” (HCS), designed to increase the homogeneity of deposited precious metal thicknesses. The thicknesses of each plate were evaluated by XRF analysis using the fundamental parameters approach [95]. XRF is a fundamental technique in electroplating facilities because it allows for non-destructive control of thickness and metal distribution with fast and robust measurements. This enables the adjustment of deposition parameters such as current density and time for DC, as well as Ton and Toff for PC. ED-XRF instruments are now standard in electroplating fashion companies, but their use in optimizing the production process is often limited by the operator’s insufficient knowledge. The commercial software associated with the equipment often functions as a black box, creating the misconception that employees merely need to press a button. In reality, it is a complex technique that requires qualified personnel.

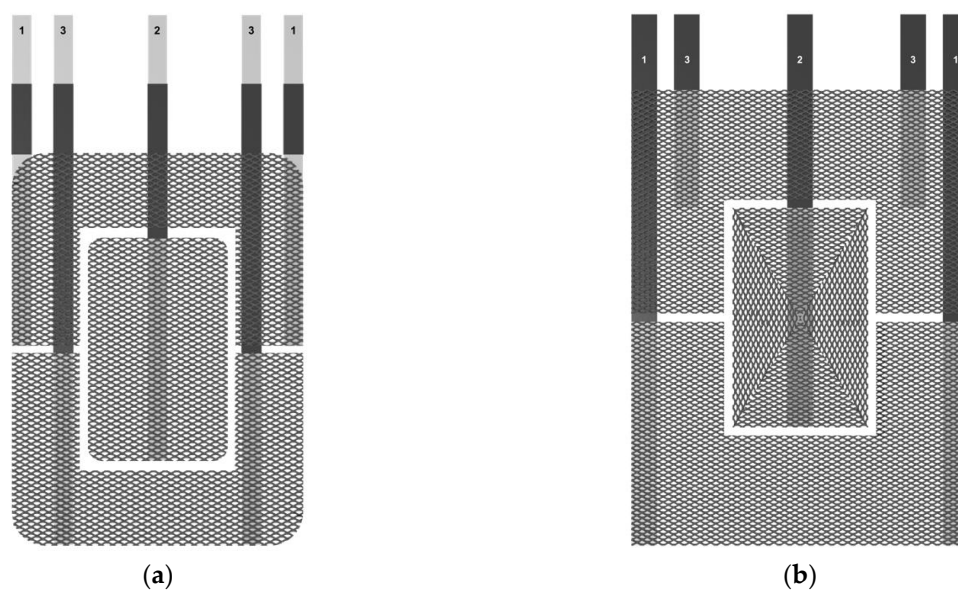
The modalities used to collect the data are shown in Supplementary S1.

Italfimet RAEP aims for the maximum thickness uniformity of precious metal electroplating filling inside the working rack. The device is based on the supply of DC, distributed inside the electroplating tanks with the aim of minimizing the effect of the presence of areas with high and low current density within the electroplating system. This is achieved by pre-setting the direct current to be distributed in multiple zones within the system itself. In detail, the anodes consist of three anodic elements coated with mixed oxides, which have 3 different anode outputs. Anodes 1 and 3 are the outer ones and have a complementary shape to the inner anode 2 (Figure 4a). The system allows the current of the external anodes to be modulated in a range of instrumental settings from  $-999.9$  to  $+100.0$  (dimensionless values), in the upper section of the anode (“high-cut”) and in the lower one (“low-cut”) independently. Based on the authors’ industrial experience, the current was distributed on the three anodes following Equation (11)

$$i_1 = \frac{i_{tot}(h+1)}{3+h+l}; \quad i_2 = \frac{i_{tot}}{3+h+l}; \quad i_3 = \frac{i_{tot}(l+1)}{3+h+l} \quad (11)$$

where  $i_1$ ,  $i_2$ ,  $i_3$  are respectively the current applied to the upper, center and lower anodes and  $h$  and  $l$  are, respectively, the high-cut and the low-cut values. Moreover,  $i_1 = 0$  if  $h > -1$ ;  $i_3 = 0$  if  $l > -1$ ;  $i_1 = i_2 = i_3 = 0$  if  $h + l > -3$ . In this work the default parameters provided by the supplier were chosen: high-cut of  $-10.0$  and low-cut of  $-30.0$ . The manufacturing company of RAEP reports a saving on the cost of the deposition of an average precious metal estimated in the order of 10–15% in addition to a significant reduction in the duration of work cycles related to the deposition of precious metals. This system is applicable to every precious metal plating process on the market, and it is easily implementable within each electroplating tank [96].

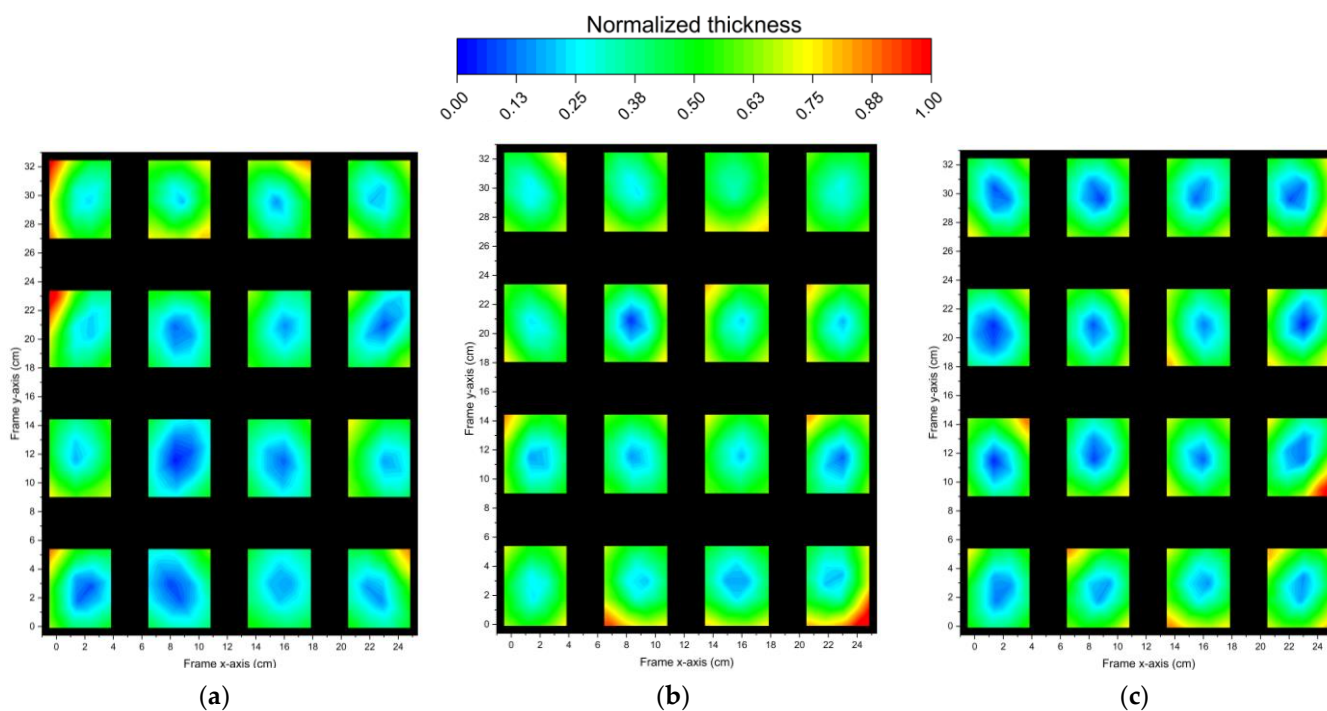
LBT-HCS uses a current rectifier “High Performance System” (HPS), designed to distribute applied currents according to the different areas of the rack, to be used with a specific system of three anodes associated with three anode outputs (Figure 4b); the central anode has a convex pyramidal shape. The system makes it possible to reduce the differences in current density that can occur between the outer and internal parts of the rack. The current can be modulated for all three electrodes setting the percentages and delays for high, medium and low zones. LBT reports a case study carried out on a palladium electroplating formulation in which a reduction of about 11% in mass of metal deposited and a reduction in the standard deviation in measured thicknesses is observed on minimal thicknesses of  $0.8 \mu\text{m}$  of deposit, evidence of increased homogeneity of the deposit [97]. To confirm the data reported by the suppliers of three-way anode systems, we carried out an empirical validation. In this work, the single rack settings given by the supplier were used: percentage high zone 35.0%, percentage medium zone 55.0%, percentage low zone 10.0%, 20 s delay in low area.



**Figure 4.** Anode schemes of (a) the Italfimet RAEP system, where 1 indicates the connectors related to the upper section of the three-anode system, 2 the connector related to the middle section and 3 the connector related to the lower section; (b) the LBT HCS system, where 1 indicates the connectors related to the lower section of the three-anode system, 2 the connector related to the middle section and 3 the connector related to the upper section.

The results of XRF measurements are reported in Table S1 and normalized distributions of electrodeposited gold thicknesses are reported in Figure 5.

As expected, in the center of each plate, there is an area of low deposited thickness; this problem is visibly mitigated in the case of the result obtained by employing the RAEP system.



**Figure 5.** Normalized distributions of electrodeposited gold thicknesses, measured by XRF analysis, relative to a sample obtained (a) under standard conditions (DC1); (b) using the RAEP system; (c) using the HCS. The  $x$  and  $y$  axes represent the coordinates inside the plating rack, which contains 16 plates arranged in rows and columns of 4. Areas of the rack where there are no plates are shown in black.

These results are confirmed by the standard deviation values obtained on the entire rack (Table 1): the RAEP system shows a significant reduction in the standard deviation value, both in terms of absolute and percentage values. The values obtained in the case of the HCS system are comparable to those obtained in standard conditions. It is also possible to assess how the RAEP and HCS systems reduce the dispersion of thickness within each plate.

**Table 1.** Mean values and standard deviations of the average thickness of each plate, related to XRF thickness measurements performed on the samples of the entire rack obtained under standard conditions and using the RAEP and HCS systems.

	Standard DC1	RAEP	HCS
Average thickness ( $\mu\text{m}$ )	$0.57 \pm 0.05$	$0.52 \pm 0.05$	$0.53 \pm 0.05$
Standard deviation ( $\mu\text{m}$ )	0.13	0.09	0.13
Standard deviation %	23.75	18.23	25.46
Standard deviation of the averages of each plate ( $\mu\text{m}$ )	0.052	0.016	0.022
Standard deviation of the averages of each plate ( $\mu\text{m}$ )%	9.17	3.03	4.10

Therefore, it can be stated that the RAEP system increases the homogeneity of the deposits throughout the entire rack, allowing to reduce the overall metal used to guarantee the minimum thicknesses required. The HCS system does not decrease the standard deviation relating to all thickness measurements, but reduces the difference observed between the various plates.

To further evaluate the performance of these systems, process capability analyses were carried out. A process capability study predicts whether a manufacturing process can repeatably produce parts that meet specifications. To make these assessments, the parameters  $C_p$  and  $C_{pk}$  were used [98].  $C_p$  (Equation (12)) measures whether the process spread is narrower than the specification width, hence the potential capacity of the process. While  $C_{pk}$  (Equation (13)) measures both the centering of the process as well as the spread of the process relative to the specification width, hence actual capacity of the process.

$$C_p = \frac{USL - LSL}{6\sigma} \quad (12)$$

$$C_{pk} = \text{Min}\left(\frac{USL - \bar{x}}{3\sigma}; \frac{\bar{x} - LSL}{3\sigma}\right) \quad (13)$$

where  $USL$  and  $LSL$  are respectively the customer-defined limits upper and lower process specification customer-defined limits (VOC) and  $\sigma$  is the standard deviation of the process,  $0.55 \mu\text{m}$  was used as the  $USL$  and  $0.45 \mu\text{m}$  as the  $LSL$ .

As shown in Table 2, The RAEP system improves the value of  $C_p$  over results obtained under standard conditions, while the HCS system returns results comparable to it. The RAEP and HCS systems both allow the improvement of the parameter  $C_{pk}$  (the increase in these parameters is a positive result).

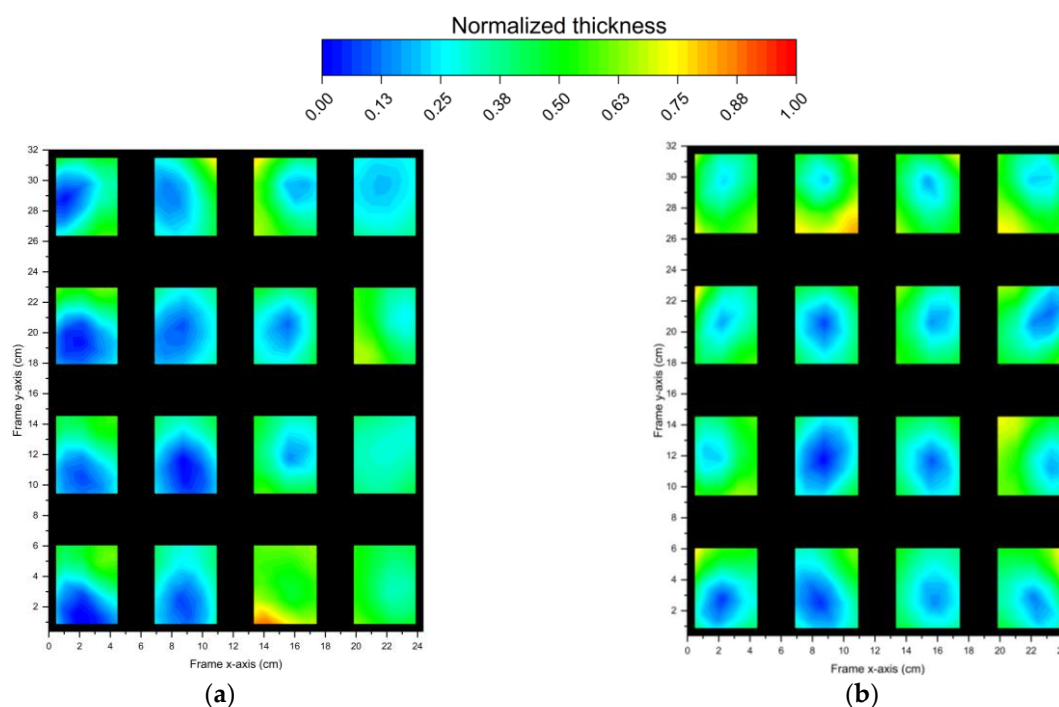
**Table 2.** Evaluation of  $C_p$  and  $C_{pk}$  values on samples obtained under standard conditions and using the RAEP and HCS systems.

	Standard DC1	RAEP	HCS
$C_p$	0.12	0.18	0.12
$C_{pk}$	-0.044	0.110	0.054

### 3.2. Pulsed Plating System

The same evaluations performed in the previous section were carried out on the thickness distribution comparing the deposition obtained by operating in DC and PC. To compare the results reported in the literature [99] with the outcomes shown by three-electrode DC anode systems, we carried out an empirical data validation. The study was performed on a gold deposit electrodeposited by means of the commercial “Bluclad 8614 MUP” electroplating solution on the plates described in Supplementary S1; the latter contains all the operational specifications.

Normalized distributions of electrodeposited gold thicknesses are reported in Figure 6. The use of pulsed current improves the overall homogeneity of the thickness of the deposits. The data used to obtain the thickness distribution maps are reported in Table S2.



**Figure 6.** Normalized distributions of electrodeposited gold thicknesses, measured by XRF analysis, relative to a sample obtained (a) under standard DC conditions (DC2); (b) under PC deposition conditions. The  $x$  and  $y$  axes represent the coordinates inside the plating rack, which contains 16 plates arranged in rows and columns of 4. Areas of the rack where there are no plates are shown in black.

As can be assessed from the results shown in Table 3, the use of pulsed current reduces the percentage standard deviation.

**Table 3.** Mean values and standard deviations of the average thickness of each plate, related to XRF thickness measurements performed on the samples of the entire rack obtained under direct current conditions and under pulsed current conditions.

	Standard DC2	PC
Average ( $\mu\text{m}$ )	$0.49 \pm 0.05$	$0.52 \pm 0.05$
Standard deviation ( $\mu\text{m}$ )	0.15	0.15
Standard deviation %	31.66	29.81
Standard deviation of the averages of each plate ( $\mu\text{m}$ )	0.080	0.091
Standard deviation of the averages of each plate ( $\mu\text{m}$ )%	16.36	17.67

It can be stated that the PC system slightly increases the homogeneity of the deposits throughout the entire rack, making it possible to reduce the overall metal used to guarantee the minimum thicknesses required.

On the other hand, it can be seen how operating with pulsed current in these conditions slightly increases the standard deviation of the average thickness of each plate.

An evaluation of the parameters  $C_p$  and  $C_{pk}$  was also carried out; the results are shown in Table 4.

**Table 4.** Evaluation of  $C_p$  and  $C_{pk}$  values on samples obtained under direct current conditions and under pulsed current conditions.

	Standard DC2	PC
$C_p$	0.11	0.11
$C_{pk}$	0.080	0.075

While the value of  $C_p$  shows no appreciable changes in the case of PC in comparison to DC, the value of  $C_{pk}$  worsens, meaning that the PC process still has room for improvement.

$C_p$  and  $C_{pk}$  results, even with improved operating conditions using RAEP, HCS and PC systems, are still suboptimal. Values of  $C_p$  and  $C_{pk}$  equal to 2 should be considered optimal, while values of 1 are considered barely acceptable [98]. The distance between optimal values of capability estimators, and the results obtained on in-line production processes can be explained by the fact that customers specifications are arbitrary, especially for the high fashion market. Clients only indicate a minimum thickness, not considering the distribution of it and the geometry of the artifact. In the field of high fashion accessories, brands often do not specify the measurement spot causing the approval of the quality control step to be highly influenced by the arbitrariness of the operator. Hence, analytical estimators such as  $C_p$  and  $C_{pk}$ , fail to represent the correctness of a process that lacks a profound structuring of demand.

This testifies that the field of electroplating in the high fashion industry shows ample room for improvement, both from an electrochemical engineering point of view and on the demand side and management of the production process: in the first case working on both anode geometries and current waveforms, and in the second case working on correctly disclosing the issues and physical chemistry behind electrodeposition to line workers. To effectively integrate the characteristics of pulsed current depositions with three-way rectifiers, several enhancements are necessary for electroplating factories. Firstly, the hardware must be optimized to utilize both features synergistically. Additionally, a specific formulation of the electroplating bath needs to be developed. Proper training for the personnel in the electroplating department is also crucial. Achieving these improvements is financially challenging for many local electroplating industries, which are often small to medium-sized companies.

### 3.3. Corrosion Tests

In the literature, there are numerous tests to ensure quality control and to verify the performances of the coatings [20,92]. Among them, neutral salt spray has been chosen to be a benchmark of the systems discussed in this review.

The 4 samples along the diagonal of the electroplating rack were selected, the purpose of this sampling is to evaluate the effects of corrosion as the position in the rack changes and to correlate the results obtained with those achieved in the previous paragraphs. The samples were tested against neutral salt spray (NSS) test ISO 9227 for 48 h [100]. During this time, the corrosion behavior of the different coatings was monitored by visual investigation (Figures S1–S5). The samples were visually evaluated by reporting the results with values in the range of 1 to 5, where 5 means no variation occurred on the surface of the sample; 4 slight variation; 3 visible variation; 2 evident variation; and 1 considerable variation. This evaluation metric is adopted by major analysis companies in the

field of metal accessories of luxury brands [92]. The outcomes are reported in Table S3. Standard DC1 samples (obtained in the standard conditions using “Bluclad 8693” electroplating solution) showed a 4.3 average result, RAEP samples 4.5, HCS samples 3, Standard DC2 samples (obtained in the standard conditions using “Bluclad 8614 MUP” electroplating solution) 1.5 and pulsed current samples 2.8.

The results obtained using the RAEP show an improvement over the ones obtained operating under the standard conditions; on the other hand, the use of the HCS system led to a worsening of the performances. However, it is important to note that the outcomes obtained using the latter operating conditions resulted in more homogeneous outputs, this agrees with the results obtained during the evaluation of thicknesses. Depositions using pulsed current resulted in a marked increase in corrosion resistance performance.

Given the results observed in the previous paragraph, where we pointed out that the PC system slightly increases the homogeneity of the deposits throughout the entire rack, we can hypothesize that such a marked change in corrosion resistance with respect to a slightly different homogeneity is due to other factors that come into play using pulsed current, such as a change in the chemical–physical structure of the deposit compared with that obtained under direct current conditions. As reported in the literature the use of pulsed current can lead to changes in the morphology of the structure of the deposit [23]. This result is very interesting because it highlights the possibility of obtaining deposits that exhibit greater corrosion resistance for the same amount of precious metal used, with clear advantages both economically and environmentally.

#### 4. Recovery of Metals

The exponential growth of the world’s population and the limitation of natural resources are presenting new challenges. Pollution prevention, waste minimization and the recycling of end-of-life (EOL) products have become primary topics of interest [101,102]. Sustainable development involves creating materials and products that can be more easily recycled through proper management. In terms of sustainability, recycling activities aim to maximize reuse, minimize energy consumption, reduce costs and waste and ideally achieve upcycling. The rapid pace of industrialization is increasing the demand for precious metals, while high-quality natural resources are dwindling, causing operating costs to skyrocket. Consequently, there is a growing need for education on the recovery of these metals.

Due to industrialization, the amount of solid and liquid waste generated from various technological processes and consumer goods is rising, particularly in developing countries. This waste can be either organic or inorganic. Inorganic waste contains toxic metallic and non-metallic elements that have severe negative impacts on ecosystems. Some of these non-ferrous metals have a moderate deterioration rate, persisting for extended periods and exerting cumulative toxic effects. Additionally, many of these elements are carcinogenic [101].

The most significant solid waste materials include non-ferrous metals such as copper, nickel, zinc, chromium, molybdenum and gold, among other potential heavy metals. Heavy metals are elements with atomic weights between 63.5 and 200.6 and a density greater than 5 g/cm<sup>3</sup>. They are characterized by high stability and low biodegradability, [103,104], leading to bioaccumulation and biomagnification in living organisms [105].

Many elements fall into this category, but the ones listed in Table 5 are particularly relevant in the environmental context [106]. Heavy metals cause serious health effects, including reduced growth and development, organ and nervous system damage, cancer and in extreme cases, death. The maximum contaminant level (MCL) standards, for those heavy metals, established by United State Environmental Protection Agency (USEPA) [107] are summarized in Table 5.

**Table 5.** MCL standards for the most hazardous heavy metals.

Heavy Metal	Toxicities	MCL (mg/L)
<b>Arsenic</b>	Skin manifestations, visceral cancers, vascular disease	0.05
<b>Cadmium</b>	Kidney damage, renal disorder, human carcinogen	0.01
<b>Chromium</b>	Headache, diarrhea, nausea, vomiting, carcinogenic	0.05
<b>Copper</b>	Liver damage, Wilson disease, insomnia	0.25
<b>Nickel</b>	Dermatitis, nausea, chronic asthma, coughing, human carcinogen	0.20
<b>Zinc</b>	Depression, lethargy, signs and increased neurological thirst	0.80
<b>Lead</b>	Damage to the fetal brain; diseases of the kidneys, circulatory system and nervous system	0.006
<b>Mercury</b>	Rheumatoid arthritis; diseases of the kidneys, circulatory system and nervous system	0.00003

Overall, 75% of copper metal today is used in the electronics, communication and energy sectors [108]—all areas from which the ecological transition will pass. Copper also performs essential work in animal metabolism, but the excessive ingestion of copper brings about serious toxicological concerns, such as vomiting, cramps, convulsions, or even death [109].

Zinc is a trace element essential for human health, playing a crucial role in the physiological functions of living tissue and regulating many biochemical processes. However, excessive zinc intake can lead to significant health issues, including stomach cramps, skin irritations, vomiting, nausea and anemia [110]. About 50% of the metallic zinc produced globally is used for anti-corrosion coatings on steel; 30% is used for alloys, primarily brass; and the remainder is utilized in chemicals, pigments, coinage and other minor applications [111].

Approximately 65% of the nickel consumed in the Western world is used to manufacture austenitic stainless steel, while 12% is used in superalloys. The remaining 23% is distributed among various applications, including other types of steel, rechargeable batteries, catalysts and other chemicals, coinage, foundry products and plating (9%) [112]. Exceeding critical levels of nickel can cause serious health issues such as lung and kidney problems, gastrointestinal distress, pulmonary fibrosis and skin dermatitis [113]. Nickel is also recognized as a human carcinogen [103].

Gold, although not cautioned by the EPA in terms of maximum contaminant concentration, it can be detrimental for human health. Gold is often used to treat certain diseases, such as rheumatoid arthritis and bronchial asthma; however, it shows very harmful side effects, including pulmonary toxicity, skin rash, peripheral eosinophilia and liver dysfunction [114]. Seven percent of the gold mined each year is used for medical, industrial and technological purposes, while the remaining 93% is utilized in the jewelry industry and banking, such as in the production of bars and coins [115].

The largest industrial consumption of chromium is in the protective and decorative coating of metal artifacts and in the preparation of various alloys. Oxides and chromates are used as pigments while high salts are used in the textile and tanning industries. Chromium exists in the aquatic environment primarily in two states: Cr(III) and Cr(VI). Generally, Cr(VI) is more toxic than Cr(III). Cr(VI) impacts human physiology, accumulates in the food chain and causes severe health problems, ranging from simple skin irritation to lung carcinoma [116].

The mining industry is one of the main causes of pollution on the planet: the smelting of metals, including gold, contributes about 19 million tons of sulfur dioxide (about 13 percent of global emissions) into the atmosphere each year, causing acid rain [117]. The mining, processing and refining of precious metals requires a great deal of energy: suffice it to say that 7–10% of the oil, gas, coal and hydropower produced annually worldwide (not counting the energy used in transportation) is used in these industries. Mines also generate an immense amount of waste: in 2010, 900 million tons of metal were extracted,



producing 6 billion tons of waste, most of which originated from the mining of gold, iron and copper [118].

Many countries have enacted, in the past decade, regulatory laws regarding waste management [101]; one such regulation, effective from 2020, mandates the reuse and recycling of at least 50 percent by weight of paper, metal, plastic and glass from household garbage. Unlike simple storage, these new processing methods enable the recovery of materials embedded in solid residues containing precious metals. The production of these metals from primary sources is constrained and involves high energy consumption. Therefore, recycling can significantly contribute to energy savings and the reduction of CO<sub>2</sub> emissions [119].

Precious metals are crucial in modern society, closely tied to technological advancements and daily life. Sustainable development and stricter environmental legislation are encouraging the recovery of precious metals as a viable approach to conserving natural resources and minimizing waste without incurring high costs.

An explanatory example is the case of gold: for every gram of usable gold, about 1 ton of debris is produced in the mining process [120]. In addition, water contaminated with cyanides and mercury [121] is released, and other chemicals are released into the atmosphere (such as sulfur dioxide and carbon dioxide from metal smelting [122]). A provocative report of Fairtrade Labelling Organization (a non-profit organization specialized in issuing fair and sustainable trade certifications) states that for one gold wedding ring alone, 3 tons of waste is produced and between 50 and 150 g of mercury is used [123]. Mercury, widely employed in artisanal and small-scale gold mining (ASGM) [124–126], is used because of its ability to combine with gold, allowing the separation of the precious from other minerals. The resulting product, called amalgam, is then heated to a temperature above 257 °C to vaporize the mercury it contains [126]. The use of mercury has a significant impact on the environment and on people: it has the characteristic of not biodegrading and therefore precipitating, settling on the land and consequently on agricultural products, as well as on water and therefore in fish. From there, it is transferred to humans; these areas have a higher incidence of cancer. A gold rush causes the illegal appropriation (i.e., without the consent of the population) of entire territories and the depletion and contamination of primary resources.

A step towards a society marked by sustainability, not only economically but also socially and environmentally, is perpetrated by the previously mentioned Fairtrade Labelling Organization, the one of the most recognized sustainability label [127]. Even gold can be certified as ethical gold [128]. In fact, ethical gold is mined legally, in mines that have been granted the rights to mine on the ground and in which local communities themselves are primarily employed [129]. It is also mined with greater attention to both people's safety and environmental pollution, minimizing the use of mercury and using it in closed cycles to avoid its release into the environment.

The protection of local communities, who are guaranteed minimum wages and adequate working conditions, providing jobs for women as well, fully embrace the ethics of Sustainable Development as promoted by the United Nations in points 1 (No poverty), 3 (Good health and well-being), 5 (Gender equality), 8 (Decent work and economic growth), 10 (Reduced inequalities). Environmental protection through low-impact extraction methods instead reflects goals 12 (Responsible consumption and production), 13 (Climate action), 15 (Life on land). Another fundamental certification in the fashion industry is the RJC-CoC (Responsible Jewelry Council–Chain of Custody) [130] from the Responsible Jewelry Council, a non-profit organization devoted to setting sustainability standards for the jewelry industry; such certification ensures full traceability of the production chain and guarantees responsible sourcing.

According to Stephen Lezak, an Oxford University researcher and expert in economics and the environment, we could immediately stop mining gold without having a shortage in any of the above sectors simply by recycling it [120]. According to the economic models proposed in the research, the only impact would be on the price of gold itself,

which today serves both as a safe haven asset for investors and as a “stabilizer” and financial reference for several countries. On the other hand, as far as pollution is concerned, it is estimated that if the supply of gold were derived simply from recycling there would be a decrease in air emissions and impact on ecosystems by 99%; the remaining 1% would represent pollution from the transportation and processing of the precious metal in the recycling stage.

Optimizing recovery solutions presents new avenues in research, addressing increasing demand, resource depletion and global development needs. Precious metals recovered through these processes retain their properties across multiple life cycles, enabling recycling to achieve the following:

- Recover valuable materials without loss of quality;
- Save energy compared to primary production;
- Decrease the need for mining activities;
- Minimize waste.

Industrialized nations have embraced proactive environmental policies aimed at mitigating technological risks, demonstrating significant adaptability through a culture of innovation and the adoption of long-term strategies. Discovering novel technologies for recovering precious metals can harmonize economic pressures with the imperative to preserve natural ecosystems, thereby potentially yielding a positive global impact. These goals align with the objectives of Sustainable Development Goals (SDGs) 9 (industry, innovation, and infrastructure), 11 (sustainable cities and communities) and 12.

The electroplating industry is considered highly hazardous among chemical-intensive industries due to its significant discharge of metal-contaminated wastewater [131].

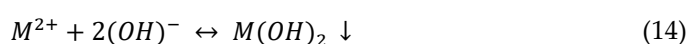
In typical electroplating industries, a substantial volume of wastewater is produced from rinsing electroplated parts [132,133] amounting to approximately 20% of the chemicals used in metal salts plating baths [134]. This wastewater contains elevated levels of metal ions that surpass the Industrial Effluent Guidelines set by the USEPA, necessitating treatment to mitigate its high toxicity before discharge into the environment [135]. Therefore, treating metal-contaminated wastewater prior to discharge into the environment is essential [131].

However, in certain electroplating industries, particularly those involving precious metals such as silver, palladium and gold, the wastewater contains significant amounts of these valuable metals. Therefore, an appropriate wastewater treatment process is necessary not only to remove heavy metals but also to recover these precious and valuable metals, addressing both economic growth and environmental considerations [133].

Various treatment techniques for heavy-metal-laden wastewater have been developed in recent years to reduce wastewater volume and enhance the quality of treated effluent. Methods such as electrowinning [136], chemical precipitation, coagulation–flocculation, flotation, ion exchange and membrane filtration are available for removing heavy metals from contaminated wastewater. Each method has its specific advantages and limitations in practical application [137].

Sophisticated electrochemical treatments such as electro dialysis [138], membrane electrolysis [139] and electrochemical precipitation [140] have also played a role in environmental protection. However, these techniques have been less extensively studied due to their high operational costs associated with energy consumption.

Chemical precipitation is a commonly employed method for removing heavy metals from inorganic effluent [141]. By adjusting the pH to basic conditions (pH 11), dissolved metal ions undergo a chemical reaction with a precipitant agent such as lime, converting them into an insoluble solid phase [142]. Typically, the precipitated metal from the solution takes the form of hydroxide. The theoretical process of heavy metal removal via chemical precipitation is illustrated in Equation (14) [142]:



where  $M^{2+}$  and  $OH^-$  represent the dissolved metal ions and the precipitant, respectively, while  $M(OH)_2$  is the insoluble metal hydroxide. The metal precipitates formed are separated through processes such as coagulation, sedimentation or filtration and then purified using chemical extraction methods [106]. Lime precipitation has been utilized to remove heavy metal cations such as Zn(II), Cd(II) and Mn(II) with an efficiency of 99%. Removal efficiencies for ions such as Cu(II) and Ni(II) are approximately 80% and 85%, respectively. Advantages in the use of precipitation relate especially to the simplicity of the process and the use of inexpensive equipment. Despite its advantages, chemical precipitation requires a large amount of chemicals to reduce metals and drawbacks such as slow precipitation of metals, poor sedimentation, aggregation of precipitates and especially excessive sludge production. These, in fact require further treatment before disposal, which has a high cost and environmental impact.

Coagulation–flocculation is effective for treating inorganic effluent with metal concentrations ranging from less than 100 mg/L to over 1000 mg/L. In this process, colloidal particles are destabilized by adding a coagulant, leading to sedimentation [143]. After coagulation, the process of flocculation follows to further increase the particle size, forming bulky flocs from the initially destabilized particles. This technique is mainly used for the treatment of Cu(II), Zn(II), Cd(II), Mn(II), which are removed with an efficiency of 99% [131]. Within an electroplating industry, this system is mainly adopted within chemical and physical wastewater treatment systems containing mainly cyanide and chromic washes (after preliminary decyanidation and dechromatization processes). The major advantages of lime-based coagulation reportedly include enhanced sludge settling, improved dewatering characteristics, bacterial inactivation capability and increased sludge stability [144]. Despite its advantages, coagulation–flocculation has limitations such as high operational costs due to chemical consumption.

Flotation is utilized to separate solids or dispersed liquids from a liquid phase using bubble attachment [131]. Attached particles are then separated from the heavy metal suspension as bubbles rise. Flotation methods include dispersed-air flotation, dissolved-air flotation (DAF), vacuum air flotation, electro-flotation and biological flotation. Among these, DAF is the most widely employed for treating metal-contaminated wastewater. Adsorptive bubble separation utilizes foaming to separate metal impurities. While it is primarily a physical separation process, flotation for heavy metal removal shows potential for industrial applications. Additional benefits include enhanced removal of small particles, shorter hydraulic retention times and cost-effectiveness, making flotation a highly promising option for treating metal-contaminated wastewater [145]; towards Cu(II) and Ni(II) ions there is a removal efficiency of 98%, while with regard to Cr(VI) the efficiency is between 95% and 98%.

Membrane filtration has garnered significant interest for treating inorganic effluent because it can eliminate suspended solids, organic compounds and inorganic contaminants such as heavy metals. Depending on the particle size that needs to be retained, different types of membrane filtration—such as ultrafiltration, nanofiltration and reverse osmosis—are utilized for heavy metal removal, as detailed below. Membrane filtration is among the most used techniques, in the galvanic field, within concentration systems. Concentration systems means all those technologies adopted for the treatment and purification of water that lead to the recovery and/or reduction of wastewater. Another technique, although less widely used in surface treatment, is electrodialysis (presented later).

Ultrafiltration (UF) utilizes permeable membranes to separate heavy metals, macromolecules and suspended solids from solutions containing inorganic compounds based on the pore size (5–20 nm) and the molecular weight (1000–100,000 Da) [106,131,146]. Depending on the membrane's characteristics, UF can achieve removal efficiencies exceeding 90% for metals with concentrations ranging from 10 to 112 mg/L.; this applies both to copper, nickel and cobalt, whose removal efficiency is 100%, but is also used for Cr(III) with a rejection rate of 95%.

Nanofiltration (NF) bridges properties of both UF and RO membranes, utilizing steric (sieving) and electrical (Donnan) effects in its separation mechanism. This membrane is notable for its small pore size and surface charge, enabling the rejection of charged solutes smaller than the membrane pores along with larger neutral solutes and salts [147]. Typically, NF membranes can effectively treat inorganic effluent containing metal concentrations up to 2000 mg/L. Notably, they demonstrate a significant 95% retention rate for Ni(II) ions.

Reverse osmosis (RO) is a pressure-driven membrane process where water permeates through the membrane while heavy metals are retained. RO technology has evolved to accommodate increasingly stringent environmental regulations, utilizing membranes with pore sizes as small as 10–4  $\mu\text{m}$  [148]. Generally, RO is more effective than UF and NF for removing heavy metals from inorganic solutions, achieving removal rates exceeding 97% for metal concentrations ranging from 21 to 200 mg/L. Also in this case cations with a greater rejection rate are Cu(II) and Ni(II) [149].

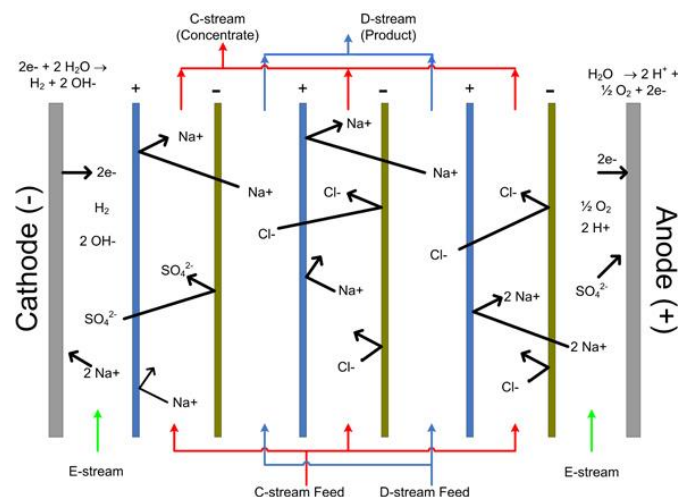
Ion exchange is also widely used globally for treating heavy-metal-laden wastewater. In ion exchange, there is a reversible exchange of ions between the solid and liquid phases. Here, an insoluble resin removes ions from an electrolytic solution and releases ions of similar charge in an equivalent amount, all without any structural alteration of the resin. [146]. Ion exchange is also employed for the recovery of valuable heavy metals from inorganic effluent [150]. Once the loaded resin has separated the metals, they can be recovered in a more concentrated form through elution using appropriate reagents. In the electroplating industry, resin systems are widely used, mainly for the recovery of washing water. These equipment therefore allows for a reduction in the amount of water to be discharged and purified, thus ridiculing the size of purification plants. The greatest response occurs with Cr(III) and Cr(VI); in fact, in both cases, the cations are removed with a rate of 90–100%. Before employing ion exchange, it is essential to implement adequate pretreatment systems for secondary effluent, including the removal of suspended solids from wastewater. Furthermore, not all heavy metals have suitable ion exchange resins available, and the associated capital and operational costs can be substantial.

Adsorption has emerged as a viable alternative treatment method for heavy-metal-laden wastewater. Adsorption is a surface process where the concentration of a specific component (referred to as the adsorbate) in a gas or liquid stream increases at the surface or interface of a porous solid (known as the adsorbent). Depending on the forces brought into play, there are two types of adsorptions: chemical adsorption and physical adsorption [131]. The types of adsorbents widely used for PM recovery from wastewater are activated carbon [151] and carbon nanotubes [103], but also low-cost adsorbents such as agricultural and industrial wastes [152]. Because of its extensive surface area, high absorbency and surface reactivity, activated carbon is effective for removing metals such as Ni(II), Cr(VI), Cd(II), Cu(II) and Zn(II) from inorganic effluent. The advantages of adsorption methods include straightforward operating conditions and the affordability of adsorbent materials. However, these methods are disadvantaged by low selectivity, low recovery efficiency and the generation of waste products.

Electrowinning is an electrolysis-based method where the metal cations present in wastewater are reduced on a cathode inside the solution [153]. This methodology due its simplicity is the most common metal-recovery technique in industrial electroplating plants working in the decorative field. A commercial set-up is usually made by two parallel MMO anodes with, between them, a copper mesh that serves as cathode. The main advantage of the method is the simplicity and the low installation costs, while it has deficiency in recover metals from low concentrated wastewater which can be overcome if coupled with techniques such as electrodialysis [138]. Electrowinning is often representing the first metal recover procedure as the apparatus is usually placed in the rinsing tank that follows the electroplating one.

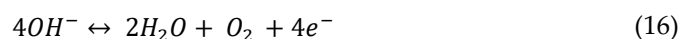
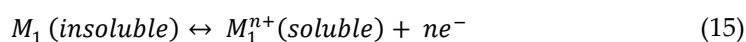
Electrodialysis (ED) is a membrane-based separation process where ionized species in a solution are transported through ion exchange membranes under an electric potential

[106], as shown in Figure 7. These membranes are thin plastic sheets with either anionic or cationic properties. As the solution containing ionic species flows through the cell compartments, anions migrate towards the anode and cations towards the cathode, crossing the anion-exchange and cation-exchange membranes [154]. This method can recover valuable metals such as Cr and Ni with efficiencies of 90% and 99%, respectively.

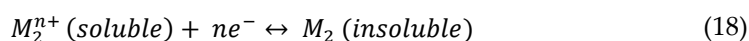


**Figure 7.** Electrodialysis principles [155] (image under Creative Commons CC BY 4.0 license, all rights and intellectual property belong to the authors; for more information, see <https://creativecommons.org/licenses/by/4.0> accessed on 15 April 2024).

Membrane electrolysis (ME) is another method used to eliminate metallic impurities from metal finishing wastewater. This is a chemical process activated by an electrolytic potential and this technique employs two types of cathodes: a standard metal cathode (electrowinning) and a high-surface-area cathode [139]. When an electrical potential is applied across an ion exchange membrane, redox reactions occur at the electrodes. In the anode, oxidation reactions occur as follows:



In the cathode, the following reduction reactions take place:

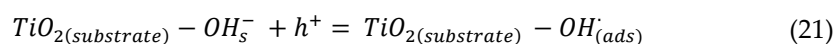
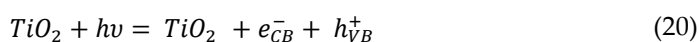


M and n represent the metal and the coefficient of the reaction component, respectively. The n coefficient depends on the state oxidation of the metal ions. This technique finds widespread acceptance in all galvanic industries, where it is used for the treatment of wastewater produced with rinse water. The metals most involved in the treatment are certainly precious metals, such as palladium and gold, but copper and nickel are also included. Different from ED, ME can be used to treat electroplating wastewater with a metal concentration less than 10 mg/L or more than 2000 mg/L. The major drawback of membrane electrolysis is its high energy consumption [131].

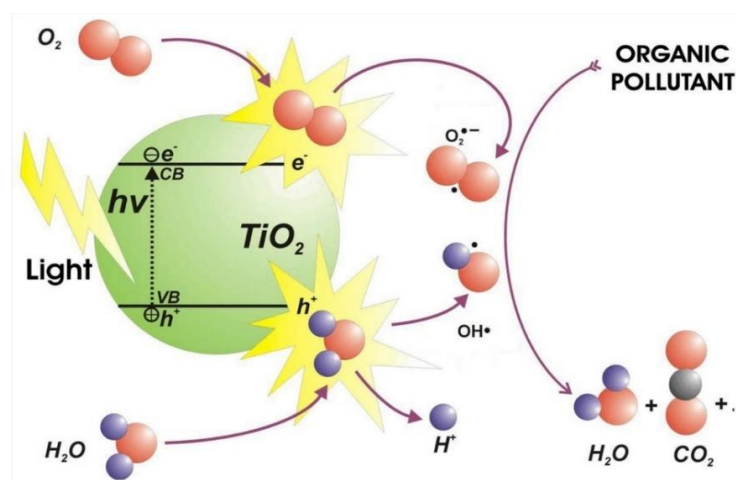
Electrochemical precipitation (EP) is utilized to enhance the removal of heavy metals from polluted wastewater, often replacing traditional chemical precipitation methods. Studies employing EP have focused on removing Cr(VI) from actual electroplating effluents [131]. Generally, electrochemical precipitation processes can effectively treat

inorganic effluent containing metal concentrations exceeding 2000 mg/L. Depending on electrode characteristics, the electrochemical process can operate under acidic or basic conditions [156]. Heavy metal removal is achieved through electrochemical oxidation/reduction reactions within an electrochemical cell, eliminating the need for continuous addition of redox chemicals and thereby reducing space, time and energy consumption costs.

Photocatalysis using semiconductors in aqueous suspension has garnered significant attention in the last decade, particularly for solar energy conversion [106]. This process facilitates the rapid and efficient degradation of environmental pollutants. When the semiconductor–electrolyte interface is illuminated with light energy exceeding the semiconductor’s band gap, electron–hole pairs ( $e^-/h^+$ ) form in the conduction and valence bands of the semiconductor, respectively [157]. These charge carriers migrate to the semiconductor surface, where they can oxidize or reduce species in the solution with suitable redox potentials. Various semiconductors such as  $TiO_2$ , ZnO,  $CeO_2$ , CdS and ZnS have been employed for this purpose. Figure 8 shows the conceptual reaction path of photocatalysis over a titanium dioxide particle. The reaction mechanism is reported below in Equations (20)–(22):



Several studies were reported for the photocatalytic reduction of Cr(VI) and the degradation, using UV-irradiated  $TiO_2$ , of the complex cyanide with concurrent removal of copper [158].



**Figure 8.** The conceptual reaction path of photocatalysis over  $TiO_2$  [159] (image under Creative Commons CC BY 4.0 license, all rights and intellectual property belong to the authors; for more information, see <https://creativecommons.org/licenses/by/4.0>).

Generally, physical–chemical treatments offer several advantages, including rapid processing, ease of operation and control and the flexibility to adjust to variable conditions such as seasonal flows and complex discharge patterns. Unlike biological systems, physical–chemical treatments can accommodate fluctuating input loads and flow rates. Chemical plants can be modified as needed, and the treatment systems require less space and lower installation costs. However, these benefits are counterbalanced by drawbacks such as high operational costs due to chemical usage, energy consumption and expenses associated with sludge disposal. Nevertheless, with advances in reducing chemical costs through the use of low-cost adsorbents and improving sludge disposal methods, physical–chemical treatments have emerged as among the most suitable options for treating inorganic effluent [106].

Electrochemical techniques for treating heavy metal wastewater are recognized for their rapidity and precise control, requiring minimal chemical inputs, yielding substantial reductions and generating less sludge. However, their widespread adoption is hindered by significant initial capital investment and the expense of electricity supply, limiting their further development [103]. Table 6 summarizes the main advantages and disadvantages of the various treatments for electroplating wastewater.

**Table 6.** Different treatment techniques for wastewater and their advantages and disadvantages.

Type of Treatment	Advantages	Disadvantages
<b>Chemical precipitation</b> [142]	Low cost, simple operation	Sludge generation, additional operational cost for sludge disposal
<b>Coagulation–flocculation</b> [144]	Reduced time for suspended solids to settle, enhanced sludge settling	Sludge production, extra operational cost for sludge disposal
<b>Dissolved air flotation</b> [145]	Low cost, reduced hydraulic retention time	Additional treatments are necessary to enhance the removal efficiency of heavy metals
<b>Ultrafiltration</b> [131]	Smaller space requirement	High operational cost, susceptibility to membrane fouling
<b>Nanofiltration</b> [147]	Low pressure than RO (7–30 bar)	Costly, prone to membrane fouling
<b>Reverse osmosis</b> [148]	High rejection rate, ability to withstand high temperature	High energy consumption due to required pressure (20–100 bar), susceptible to membrane fouling
<b>Ion exchange</b> [146]	No sludge generation, velocity	Not all resins are adequate for metal removal, high capital cost
<b>Adsorption</b> [131]	Low cost, simple operating conditions, wide pH range, high metal binding ability	Low selectivity, waste products
<b>Electrowinning</b> [138]	Low installation cost, simplicity	Need of moderately concentrated metal cation solutions
<b>Electrodialysis</b> [154]	High separation selectivity	High operational cost due to membrane fouling and energy consumption
<b>Membrane electrolysis</b> [139]	Use in a wide range of metal concentrations	High energy consumption
<b>Electrochemical precipitation</b> [156]	Less chemicals, acidic or basic conditions	Sludge production
<b>Photocatalysis</b> [157]	Simultaneous removal of metals and organic pollutant, fewer harmful by-products	Slow process, limited applications

None of the treatments discussed has proven universally effective or applicable for removing heavy metals. As future regulations increasingly emphasize industrial compliance with legal limits on residual metal concentrations in discharge, there is significant value in exploring diverse treatment methods that can aid industrial users in meeting environmental requirements. While numerous methods exist for treating heavy-metal-laden wastewater, it is crucial to emphasize that choosing the most appropriate treatment depends on several factors. These include the initial metal concentration, overall treatment effectiveness compared to alternative technologies, plant flexibility and reliability, environmental impact and economic considerations such as capital investment and operational costs, including energy consumption and maintenance.

Ultimately, the selection of the most suitable treatment system for inorganic effluent, particularly within the electroplating industry, hinges on technical feasibility, operational

simplicity and cost-effectiveness. This is particularly crucial given the diverse and metal-rich nature of electroplating wastewater. In this case, the use of only one recovery technique will never be satisfactory, but there is a need for several treatment steps working in synergy with each other to break down all harmful pollutants to a greater extent. All the factors mentioned above should be taken into consideration when choosing the most efficient and cost-effective treatment method to safeguard the environment. It is important to underline how electroplating companies, especially in the decorative field, have to understand the importance not only of installing commonly used metal-recovery methods (e.g., electrowinning), but also optimize them within the necessity of each specific company and invest in research and development to study if other methods (as the one listed in this chapter) could better fit the needs and if the combination different techniques could lead to improved results, developing internal recovery protocols.

## 5. Conclusions

For over two decades, sustainability in the plating industry has been one of the key concerns of that industry. This makes it critical for the industry to assess the overall sustainability of virtually all plating facilities and then develop both short-term and long-term approaches for improving sustainability performance. In this manuscript, we discussed three different but complementary lines of action to improve the sustainability of the electroplating industry in terms of in Agenda 2030 SDGs, especially in non-mandatory fields such as the decorative one. Different plating techniques, *in silico* simulations and the metal recovery are linked to each other in minimizing material usage and, consequently, metal extraction. The principal SDGs addressed by all of them are the SDG 8 (decent work and economic growth), SDG 10 (reduce inequalities), SDG 12 (responsible consumption and production) and SDG 13 (climate action). *In silico* simulations streamline the trial-and-error phase, significantly reducing waste and enhancing business productivity. Optimized electroplating techniques enable the creation of more uniform deposits using less precious metal, which not only meets the stringent standards of major brands but also diminishes metal usage and boosts the competitiveness of companies investing in R&D. Enhanced metal recovery processes within businesses lower waste and operational costs, making products more affordable for less affluent populations. Efficient use of metals lessens the need for mining, often conducted in developing countries where it can cause substantial environmental and social harm. Mitigating these impacts improves local communities' livelihoods, fostering greater equity. By minimizing precious metal waste, companies directly contribute to reducing overall waste generation. This efficient metal use decreases the need for new resource extraction, leading to more sustainable production practices. Enhanced production efficiency means that fewer resources are required to achieve the same output, often resulting in lower energy consumption and reduced greenhouse gas emissions. Reducing precious metal waste also cuts emissions associated with the extraction, refining and processing of these materials, further supporting emission reduction efforts. Improved production efficiency and waste minimization bolster company resilience against the economic impacts of climate change, such as resource price volatility and stricter emissions regulations. Investing in waste reduction and efficiency technologies can spur innovative solutions applicable across various sectors, thereby contributing to broader climate change mitigation efforts. Despite that, to reach good sustainability standards, there is a great deal of work remaining. In addition to investing in process management efficiency improvements, it is fundamental that fashion designers take care of the whole production process, thinking outside the existing schemes to develop new sustainable geometries, and that industries embrace simulations to test them. Hence, deposition techniques should be improved by trying to combine the characteristics of pulsed current depositions with three-way rectifier engineering and calibrate the deposition parameters with analytical techniques such as spectroscopy. Furthermore, electroplating facilities need to dedicate labor to select and optimize recovery methods according to their specific internal needs. Finally, it was demonstrated how, in order to



reach the sustainability goals, it is fundamental to invest in research and development divisions, valorize qualified personnel and promote technological-transfer collaboration with universities and research institutes.

**Supplementary Materials:** The following supporting information can be downloaded at: <https://www.mdpi.com/article/10.3390/su16135821/s1>, S1. Materials and Methods. Table S1. Data on the position on the galvanic frame and the thicknesses of electrodeposited gold relative to the sample obtained under standard conditions, using the Anti-Peak Effect Rectifier (RAEP) system and using the Homogeneous Coating System (HCS); Table S2. Data on the position on the galvanic frame and the thicknesses of electrodeposited gold relative to the sample obtained under direct current conditions and under pulsed current conditions; Table S3. Sample results after NSS test ISO 9227 for 48 h; Figure S1. Samples obtained under standard conditions using "Bluclad 8693" electroplating solution; a) image obtained before corrosion test, b) image obtained after corrosion test; Figure S2. Samples obtained using the Anti-Peak Effect Rectifier (RAEP) system using "Bluclad 8693" electroplating solution; a) image obtained before corrosion test, b) image obtained after corrosion test; Figure S3. Samples obtained using the Homogeneous Coating System (HCS) system using "Bluclad 8693" electroplating solution; a) image obtained before corrosion test, b) image obtained after corrosion test; Figure S4. Samples obtained under standard conditions using "Bluclad 8614 MUP" electroplating solution; a) image obtained before corrosion test, b) image obtained after corrosion test; Figure S5. Sample obtained under Pulsed Current deposition conditions using "Bluclad 8614 MUP" electroplating solution; a) image obtained before corrosion test, b) image obtained after corrosion test.

**Author Contributions:** Conceptualization, M.I.; investigation, G.P., F.B. and E.M.; data curation, W.G.; writing—original draft preparation, W.G., G.P., F.B. and E.M.; writing—review and editing, W.G., G.P., F.B., E.M. and M.B.; visualization, L.G., M.T. and P.F.; supervision, W.G.; project administration, E.C. and M.I.; funding acquisition, M.I. and E.C. All authors have read and agreed to the published version of the manuscript.

**Funding:** The authors acknowledge the Italian Ministry of University and Research (MUR) funded by the European Union—NextGenerationEU for the National Recovery and Resilience Plan (NRRP), Mission 4 Component 2 Investment 1.3—Call for tender No. 341 of 15 March 2022—Project code PE\_00000004, CUP B83C22004890007, Project title "3A-ITALY—Made-in-Italy circolare e sostenibile".

**Institutional Review Board Statement:** Not applicable.

**Informed Consent Statement:** Not applicable.

**Data Availability Statement:** Not applicable.

**Acknowledgments:** The authors acknowledge Materia Firenze Lab Srl, Lotti Srl and Eco-Tech Finish Srl for making their production facilities and case studies equipment available for the realization of the samples presented in this manuscript. The authors also thank Fondazione CR Firenze, Fondazione per la Ricerca e l'Innovazione dell'Università degli Studi di Firenze and Confindustria Firenze for the support offered within the FABER4 project.

**Conflicts of Interest:** The authors declare no conflicts of interest.

## References

1. Sun, Z.; He, G.; Zhao, Z.; He, X.; Zhao, H. Research Progress of Electroplated Micropore for Interconnection Technology. *J. Phys. Conf. Ser.* **2023**, *2430*, 012011. <https://doi.org/10.1088/1742-6596/2430/1/012011>.
2. Zhang, Y.; An, M.; Yang, P.; Zhang, J. Recent Advances in Electroplating of Through-Hole Copper Interconnection. *Electrocatalysis* **2021**, *12*, 619–627. <https://doi.org/10.1007/s12678-021-00687-2>.
3. Pappaianni, G.; Giurlani, W.; Bonechi, M.; Calisi, N.; Cortigiani, B.; Bazzicalupi, C.; Caneschi, A.; Fontanesi, C.; Innocenti, M. Electrodeposition of MnAs-Based Thin-Film as a Possible Promising Candidate in Spintronics Applications. *J. Electrochem. Soc.* **2024**, *171*, 062502. <https://doi.org/10.1149/1945-7111/ad5112>.
4. Bandinelli, R.; Fani, V.; Bindi, B. Electroplating and Pvd Finishing Technologies in the Fashion Industry: Perspectives and Scenarios. *Sustainability* **2021**, *13*, 4453. <https://doi.org/10.3390/su13084453>.
5. Giurlani, W.; Gambinossi, F.; Salvietti, E.; Passaponti, M.; Innocenti, M. Color Measurements in Electroplating Industry: Implications for Product Quality Control. *ECS Trans.* **2017**, *80*, 757–766. <https://doi.org/10.1149/08010.0757ecst>.

6. Biffoli, F.; Giurlani, W.; Vorobyova, M.; Maccioni, I.; Giovani, C.; Salvi, M.; Cianfanelli, E.; Pagliai, M.; Innocenti, M. Tailoring Barrier Layers Design for Haute Couture through X-Ray Microanalysis: Insights and Guidelines. *Heliyon* **2024**, *10*, e32147. <https://doi.org/10.1016/j.heliyon.2024.e32147>.
7. United Nations Sustainable Development Goals. Available online: <https://sdgs.un.org/goals> (accessed on 19 March 2024).
8. Jeyamala, S.; Kumaraguru, A.K.; Nagarani, N. Occupational Health Effects Due to Nickel and Chromium Exposure in Electroplating Workers. *Toxicol. Environ. Chem.* **2012**, *94*, 1583–1590. <https://doi.org/10.1080/02772248.2012.715382>.
9. Moura, B.; Papaioannou, E.; Grigoropoulos, A.; Zoikis-Karathanasis, A.; Monteiro, H. Sustainability of Spent Nickel-Based Electroplating Baths: An Innovative Valorisation Process. *Sustainability* **2023**, *15*, 15366. <https://doi.org/10.3390/su152115366>.
10. Xu, P.; Lai, S.; Wu, L.; Chen, W.; Chen, Y.; Xu, D.; Xiang, J.; Cheng, P.; Chen, Z.; Wang, X.; et al. Insights into the Health Status of the General Population Living near an Electroplating Industry Zone: Metal Elevations and Renal Impairment. *Environ. Sci. Pollut. Res.* **2022**, *30*, 31905–31915. <https://doi.org/10.1007/s11356-022-24411-9>.
11. Yu, Y.; Xie, Y.; Ji, L.; Zhang, J.; Cai, Y.; Yang, Z. Water Management for Industrial Development, Energy Conservation, and Subjective Attitudes: A Comprehensive Risk-Oriented Model to Explore the Tolerance of Unbalanced Allocation Problem. *J. Water Clim. Chang.* **2022**, *13*, 139–157. <https://doi.org/10.2166/wcc.2021.377>.
12. Li, T.; Wei, G.; Liu, H.; Gong, Y.; Zhao, H.; Wang, Y.; Wang, J. Comparative Study of Electroplating Sludge Reutilization in China: Environmental and Economic Performances. *Environ. Sci. Pollut. Res.* **2023**, *30*, 106598–106610. <https://doi.org/10.1007/s11356-023-29849-z>.
13. Pizzetti, F.; Salvietti, E.; Giurlani, W.; Emanuele, R.; Fontanesi, C.; Innocenti, M. Cyanide-Free Silver Electrodeposition with Polyethyleneimine and 5,5-Dimethylhydantoin as Organic Additives for an Environmentally Friendly Formulation. *J. Electroanal. Chem.* **2022**, *911*, 116196. <https://doi.org/10.1016/j.jelechem.2022.116196>.
14. Satpathy, B.; Jena, S.; Das, S.; Das, K. A Comprehensive Review of Various Non-Cyanide Electroplating Baths for the Production of Silver and Gold Coatings. *Int. Mater. Rev.* **2023**, *68*, 825–861. <https://doi.org/10.1080/09506608.2022.2156723>.
15. Jasni, A.B.; Yoshihara, S. Electrodeposition of Silver in Cyanide-Free Solution Containing Pyrimidine Derivative as a Complexing Agent. *J. Electrochem. Soc.* **2023**, *170*, 092504. <https://doi.org/10.1149/1945-7111/acf6e3>.
16. El Sayed, M.A.; Elazab, N.T.; Gassoumi, M.; Ibrahim, M.A.M. Nanocrystalline Silver Coatings on Steel by Electrodeposition from Non-Polluting Aqueous Baths and Its Antibacterial Activity. *J. Taiwan Inst. Chem. Eng.* **2022**, *132*, 104212. <https://doi.org/10.1016/j.jtice.2022.104212>.
17. El Sayed, M.A.; Ibrahim, M.A.M.; Elazab, N.T.; Gassoumi, M. Electrochemical Synthesis of Nanocrystalline CuAg Coatings on Stainless Steel from Cyanide-Free Electrolyte. *Processes* **2022**, *10*, 2134. <https://doi.org/10.3390/pr10102134>.
18. Navinšek, B.; Panjan, P.; Milošev, I. PVD Coatings as an Environmentally Clean Alternative to Electroplating and Electroless Processes. *Surf. Coatings Technol.* **1999**, *116–119*, 476–487. [https://doi.org/10.1016/S0257-8972\(99\)00145-0](https://doi.org/10.1016/S0257-8972(99)00145-0).
19. Legg, K.O.; Graham, M.; Chang, P.; Rastagar, F.; Gonzales, A.; Sartwell, B. The Replacement of Electroplating. *Surf. Coatings Technol.* **1996**, *81*, 99–105. [https://doi.org/10.1016/0257-8972\(95\)02653-3](https://doi.org/10.1016/0257-8972(95)02653-3).
20. Vorobyova, M.; Biffoli, F.; Giurlani, W.; Martinuzzi, S.M.; Linsler, M.; Caneschi, A.; Innocenti, M. PVD for Decorative Applications: A Review. *Materials* **2023**, *16*, 4919. <https://doi.org/10.3390/ma16144919>.
21. Larson, C.; Farr, J.P.G. Current Research and Potential Applications for Pulsed Current Electrodeposition—A Review. *Trans. IMF* **2012**, *90*, 20–29. <https://doi.org/10.1179/174591912X13238641755178>.
22. Kalantary, M.R.; Gabe, D.R. Coating Thickness Distribution and Morphology of Pulsed Current Copper Electrodeposits. *Surf. Eng.* **1995**, *11*, 246–254. <https://doi.org/10.1179/sur.1995.11.3.246>.
23. Mariani, E.; Giurlani, W.; Bonechi, M.; Dell’Aquila, V.; Innocenti, M. A Systematic Study of Pulse and Pulse Reverse Plating on Acid Copper Bath for Decorative and Functional Applications. *Sci. Rep.* **2022**, *12*, 18175. <https://doi.org/10.1038/s41598-022-22650-x>.
24. Siddiqui, A.; Potoff, R.; Huang, Y. Sustainability Metrics and Technical Solution Derivation for Performance Improvement of Electroplating Facilities. *Clean Technol. Environ. Policy* **2023**, *26*, 1825–1842. <https://doi.org/10.1007/s10098-023-02696-9>.
25. Iñigo, E.A.; Albareda, L. Understanding Sustainable Innovation as a Complex Adaptive System: A Systemic Approach to the Firm. *J. Clean. Prod.* **2016**, *126*, 1–20. <https://doi.org/10.1016/j.jclepro.2016.03.036>.
26. Xiao, J.; Huang, Y. Technology Integration for Sustainable Manufacturing: An Applied Study on Integrated Profitable Pollution Prevention in Surface Finishing Systems. *Ind. Eng. Chem. Res.* **2012**, *51*, 11434–11444. <https://doi.org/10.1021/ie300154n>.
27. Piluso, C.; Huang, Y. Collaborative Profitable Pollution Prevention: An Approach for the Sustainable Development of Complex Industrial Zones under Uncertain Information. *Clean Technol. Environ. Policy* **2009**, *11*, 307–322. <https://doi.org/10.1007/s10098-008-0187-y>.
28. Song, H.; Bhadbhade, N.; Huang, Y. Sustainability Assessment and Performance Improvement of Electroplating Process Systems. In *Sustainability in the Design, Synthesis and Analysis of Chemical Engineering Processes*; Elsevier: Amsterdam, The Netherlands, 2016; pp. 227–248, ISBN 9780128020647.
29. Kirichenko, K.Y.; Vakhniuk, I.A.; Ivanov, V.V.; Tarasenko, I.A.; Kosyanov, D.Y.; Medvedev, S.A.; Soparev, V.P.; Drozd, V.A.; Kholodov, A.S.; Golokhvast, K.S. Complex Study of Air Pollution in Electroplating Workshop. *Sci. Rep.* **2020**, *10*, 11282. <https://doi.org/10.1038/s41598-020-67771-3>.
30. Wei, J.; Shi, P.; Cui, G.; Li, X.; Xu, M.; Xu, D.; Xie, Y. Analysis of Soil Pollution Characteristics and Influencing Factors Based on Ten Electroplating Enterprises. *Environ. Pollut.* **2023**, *337*, 122562. <https://doi.org/10.1016/j.envpol.2023.122562>.

31. Liu, T.; Wang, Z. Contamination and Health Risk Assessment of Heavy Metals in Soil Surrounding an Electroplating Factory in JiaXing, China. *Sci. Rep.* **2024**, *14*, 4097. <https://doi.org/10.1038/s41598-024-54620-w>.
32. Ohno, T. *Toyota Production System: Beyond Large-Scale Production*; CRC Press, Taylor & Francis Group: Boca Raton, FL, USA, 1988; ISBN 9781138360846.
33. Pande, P.; Neuman, R.P.; Cavanagh, R.R. *The Six Sigma Way: How GE, Motorola, and Other Top Companies Are Honing Their Performance*; McGraw-Hill Professional: New York, NY, USA, 2001; ISBN 0-07-135806-4.
34. Monday, L.M. Define, Measure, Analyze, Improve, Control (DMAIC) Methodology as a Roadmap in Quality Improvement. *Glob. J. Qual. Saf. Healthc.* **2022**, *5*, 44–46. <https://doi.org/10.36401/JQSH-22-X2>.
35. Mittal, A.; Gupta, P.; Kumar, V.; Al Owad, A.; Mahlawat, S.; Singh, S. The Performance Improvement Analysis Using Six Sigma DMAIC Methodology: A Case Study on Indian Manufacturing Company. *Heliyon* **2023**, *9*, e14625. <https://doi.org/10.1016/j.heliyon.2023.e14625>.
36. Kadir, A.M.Y.; Amar, K.; Asmal, S. A Design of Procurement Managing Tool Based on the Lean Six Sigma-DMADV: A Case Study of an Indonesian Fishery Company. *Qual. Success* **2024**, *25*, 139–146. <https://doi.org/10.47750/QAS/25.199.15>.
37. Trubetskaya, A.; McDermott, O.; Durand, P.; Powell, D.J. Improving Value Chain Data Lifecycle Management Utilising Design for Lean Six Sigma Methods. *TQM J.* **2024**, *36*, 136–154. <https://doi.org/10.1108/TQM-01-2024-0020>.
38. Niemann, J.; Reich, B.; Stöhr, C. *Lean Six Sigma*; Springer Berlin Heidelberg: Berlin/Heidelberg, Germany, 2024; ISBN 978-3-662-68743-7.
39. Safaei, A. *Discrete Event Simulation as a Lean Manufacturing Tool for Copper Plating of PCB Manufacturing*; State University of New York at Binghamton: Binghamton, NY, USA, 2012.
40. Kidwell, M. Lean Manufacturing and the Environment. *Target* **2006**, *22*, 13–18.
41. Kantichaimongkol, P.; Chutima, P. Method for Reducing Defect in Electroplating Process. *Eng. J. Chiang Mai Univ.* **2019**, *26*, 169–180.
42. Leiden, A.; Herrmann, C.; Thiede, S. Cyber-Physical Production System Approach for Energy and Resource Efficient Planning and Operation of Plating Process Chains. *J. Clean. Prod.* **2021**, *280*, 125160. <https://doi.org/10.1016/j.jclepro.2020.125160>.
43. Todeschini, B.V.; Cortimiglia, M.N.; Callegaro-de-Menezes, D.; Ghezzi, A. Innovative and Sustainable Business Models in the Fashion Industry: Entrepreneurial Drivers, Opportunities, and Challenges. *Bus. Horiz.* **2017**, *60*, 759–770. <https://doi.org/10.1016/j.bushor.2017.07.003>.
44. United Nations (UN). *Transforming Our World: The 2030 Agenda for Sustainable Development*; United Nations (UN): New York, NY, USA, 2015.
45. Wu, B.; Huang, J.; Lv, Z.; Cui, Z.; Hu, G.; Luo, J.; Selim, M.S.; Hao, Z. Experimental and DFT Study of the Effect of Mercaptosuccinic Acid on Cyanide-Free Immersion Gold Deposition. *RSC Adv.* **2020**, *10*, 9768–9776. <https://doi.org/10.1039/d0ra00925c>.
46. Pinto, G.; Silva, F.; Porteiro, J.; Míguez, J.; Baptista, A. Numerical Simulation Applied to PVD Reactors: An Overview. *Coatings* **2018**, *8*, 1–21. <https://doi.org/10.3390/COATINGS8110410>.
47. Giurlani, W.; Fidi, A.; Anselmi, E.; Pizzetti, F.; Bonechi, M.; Carretti, E.; Lo Nostro, P.; Innocenti, M. Specific Ion Effects on Copper Electroplating. *Colloids Surf. B Biointerfaces* **2023**, *225*, 113287. <https://doi.org/10.1016/j.colsurfb.2023.113287>.
48. Lai, Z.; Wang, S.; Wang, C.; Hong, Y.; Zhou, G.; Chen, Y.; He, W.; Peng, Y.; Xiao, D. A Comparison of Typical Additives for Copper Electroplating Based on Theoretical Computation. *Comput. Mater. Sci.* **2018**, *147*, 95–102. <https://doi.org/10.1016/j.commatsci.2017.11.049>.
49. Maris, P.; Sosonkina, M.; Vary, J.P.; Ng, E.; Yang, C. Scaling of Ab-Initio Nuclear Physics Calculations on Multicore Computer Architectures. *Procedia Comput. Sci.* **2010**, *1*, 97–106. <https://doi.org/10.1016/j.procs.2010.04.012>.
50. Allinger, N.L.; Zhou, X.; Bergsma, J. Molecular Mechanics Parameters. *J. Mol. Struct. THEOCHEM* **1994**, *312*, 69–83. [https://doi.org/10.1016/S0166-1280\(09\)80008-0](https://doi.org/10.1016/S0166-1280(09)80008-0).
51. Wang, J.; Wolf, R.M.; Caldwell, J.W.; Kollman, P.A.; Case, D.A. Development and Testing of a General Amber Force Field. *J. Comput. Chem.* **2004**, *25*, 1157–1174. <https://doi.org/10.1002/jcc.20035>.
52. Sprenger, K.G.; Jaeger, V.W.; Pfaendtner, J. The General AMBER Force Field (GAFF) Can Accurately Predict Thermodynamic and Transport Properties of Many Ionic Liquids. *J. Phys. Chem. B* **2015**, *119*, 5882–5895. <https://doi.org/10.1021/acs.jpcc.5b00689>.
53. Di Grande, S.; Ciofini, I.; Adamo, C.; Pagliai, M.; Cardini, G. Absorption Spectra of Flexible Fluorescent Probes by a Combined Computational Approach: Molecular Dynamics Simulations and Time-Dependent Density Functional Theory. *J. Phys. Chem. A* **2022**, *126*, 8809–8817. <https://doi.org/10.1021/acs.jpca.2c04637>.
54. Daneshmand, H.; Araghchi, M.; Asgary, M.; Karimi, M.; Torab-Mostaedi, M. New Insight into Adsorption Mechanism of Nickel–Ammonium Complex on the Growth of Nickel Surfaces with Hierarchical Nano/Microstructure. *Results Surf. Interfaces* **2021**, *3*, 100014. <https://doi.org/10.1016/j.rsufi.2021.100014>.
55. Pérez Jiménez, V.A.; Hernández-Montoya, V.; Ramírez-Montoya, L.A.; Castillo-Borja, F.; Tovar-Gómez, R.; Montes-Morán, M.A. Adsorption of Impurities from Nickel-Plating Baths Using Commercial Sorbents to Reduce Wastewater Discharges. *J. Environ. Manag.* **2021**, *284*, 112024. <https://doi.org/10.1016/j.jenvman.2021.112024>.
56. Li, Q.; Hu, J.; Zhang, J.; Yang, P.; Hu, Y.; An, M. Screening of Electroplating Additive for Improving Throwing Power of Copper Pyrophosphate Bath via Molecular Dynamics Simulation. *Chem. Phys. Lett.* **2020**, *757*, 137848. <https://doi.org/10.1016/j.cplett.2020.137848>.
57. Levine, I.N. *Quantum Chemistry*; Pearson College: Engelwood Cliffs, NJ, USA, 2013; ISBN 978-0321803450.

58. Di Grande, S.; Kállay, M.; Barone, V. Accurate Thermochemistry at Affordable Cost by Means of an Improved Version of the JunChS-F12 Model Chemistry. *J. Comput. Chem.* **2023**, *44*, 2149–2157. <https://doi.org/10.1002/jcc.27187>.
59. Verrucchi, M.; Comparini, A.; Bonechi, M.; del Pace, I.; Zangari, G.; Giurlani, W.; Innocenti, M. Electrochemical Spectroscopic Analysis of Additives in Copper Plating Baths by DRT and Multivariate Approach. *J. Electroanal. Chem.* **2024**, *954*, 118045. <https://doi.org/10.1016/j.jelechem.2024.118045>.
60. Dianat, A.; Yang, H.; Bobeth, M.; Cuniberti, G. DFT Study of Interaction of Additives with Cu(111) Surface Relevant to Cu Electrodeposition. *J. Appl. Electrochem.* **2018**, *48*, 211–219. <https://doi.org/10.1007/s10800-018-1150-1>.
61. Li, Y.; Ren, P.; Zhang, Y.; Wang, S.; Zhang, J.; Yang, P.; Liu, A.; Wang, G.; Chen, Z.; An, M. The Influence of Leveler Brilliant Green on Copper Superconformal Electroplating Based on Electrochemical and Theoretical Study. *J. Ind. Eng. Chem.* **2023**, *118*, 78–90. <https://doi.org/10.1016/j.jiec.2022.10.047>.
62. Mendieta-Moreno, J.I.; Marcos-Alcalde, I.; Trabada, D.G.; Gómez-Puertas, P.; Ortega, J.; Mendieta, J. A Practical Quantum Mechanics Molecular Mechanics Method for the Dynamical Study of Reactions in Biomolecules. *Adv. Protein Chem. Struct. Biol.* **2015**, *100*, 67–88.
63. Hou, G.; Zhu, X.; Elstner, M.; Cui, Q. A Modified QM/MM Hamiltonian with the Self-Consistent-Charge Density-Functional-Tight-Binding Theory for Highly Charged QM Regions. *J. Chem. Theory Comput.* **2012**, *8*, 4293–4304. <https://doi.org/10.1021/ct300649f>.
64. Tzeliou, C.E.; Mermigki, M.A.; Tzeli, D. Review on the QM/MM Methodologies and Their Application to Metalloproteins. *Molecules* **2022**, *27*, 2660. <https://doi.org/10.3390/molecules27092660>.
65. Braun, T.M.; Josell, D.; John, J.; Moffat, T.P. Editors' Choice—Simulation of Copper Electrodeposition in Through-Hole Vias. *J. Electrochem. Soc.* **2020**, *167*, 013510. <https://doi.org/10.1149/2.0102001JES>.
66. European Committee for Standardization EN 1811:2011+A1:2015 Reference Test Method for Release of Nickel from All Post Assemblies Which Are Inserted into Pierced Parts of the Human Body and Articles Intended to Come into Direct and Prolonged Contact with the Skin; Brussels, Belgium, 2015. Available online: <https://store.uni.com/uni-en-1811-2015> (accessed on 19 March 2024).
67. Fabbri, L.; Giurlani, W.; Mencherini, G.; De Luca, A.; Passaponti, M.; Piciollo, E.; Fontanesi, C.; Caneschi, A.; Innocenti, M. Optimisation of Thiourea Concentration in a Decorative Copper Plating Acid Bath Based on Methanesulfonic Electrolyte. *Coatings* **2022**, *12*, 1–11. <https://doi.org/10.3390/coatings12030376>.
68. Berretti, E.; Calisi, N.; Capaccioli, A.; Capozzoli, L.; Hamouda, A.M.S.; Giaccherini, A.; Giurlani, W.; Ienco, A.; Martinuzzi, S.; Innocenti, M.; et al. Electrodeposited White Bronzes on Brass: Corrosion in 3.5% Sodium Chloride Solution. *Corros. Sci.* **2020**, *175*, 108898. <https://doi.org/10.1016/j.corsci.2020.108898>.
69. Giurlani, W.; Biffoli, F.; Fei, L.; Pizzetti, F.; Bonechi, M.; Fontanesi, C.; Innocenti, M. Analytic Procedure for the Evaluation of Copper Intermetallic Diffusion in Electroplated Gold Coatings with Energy Dispersive X-Ray Microanalysis. *Anal. Chim. Acta* **2023**, *1269*, 341428. <https://doi.org/10.1016/j.aca.2023.341428>.
70. Martinuzzi, S.; Giovani, C.; Giurlani, W.; Galvanetto, E.; Calisi, N.; Casale, M.; Fontanesi, C.; Ciattini, S.; Innocenti, M. A Robust and Cost-Effective Protocol to Fabricate Calibration Standards for the Thickness Determination of Metal Coatings by XRF. *Spectrochim. Acta Part B At. Spectrosc.* **2021**, *182*, 106255. <https://doi.org/10.1016/j.sab.2021.106255>.
71. Li, S. Introduction to Electrochemical Reaction Engineering. In *Chemical Reaction Engineering*; Elsevier; Amsterdam, The Netherlands, 2017; pp. 599–651.
72. Nishiki, Y.; Aoki, K.; Tokuda, K.; Matsuda, H. Secondary Current Distribution in a Two-Dimensional Model Cell Composed of an Electrode with an Open Part. *J. Appl. Electrochem.* **1986**, *16*, 291–303. <https://doi.org/10.1007/BF01093363>.
73. Colli, A.N.; Bisang, J.M. Tertiary Current and Potential Distribution Including Laminar/Turbulent Convection, Diffusion, and Migration by the Finite Volume Method Using OpenFOAM. *Ind. Eng. Chem. Res.* **2021**, *60*, 11927–11941. <https://doi.org/10.1021/acs.iecr.1c01884>.
74. Beale, S.; Lehnert, W. *Electrochemical Cell Calculations with OpenFOAM*; Lecture Notes in Energy; Springer International Publishing: Cham, Switzerland, 2022; Volume 42; ISBN 978-3-030-92177-4.
75. Kauffman, J.; Gilbert, J.; Paterson, E. Multi-Physics Modeling of Electrochemical Deposition. *Fluids* **2020**, *5*, 240. <https://doi.org/10.3390/fluids5040240>.
76. Rahman, M.M.; Liu, W.; Lv, M.; Pan, H. Exploring SIMPLE Algorithm for All Speeds. *Ain Shams Eng. J.* **2023**, *14*, 101854. <https://doi.org/10.1016/j.asej.2022.101854>.
77. Issa, R.; Gosman, A.; Watkins, A. The Computation of Compressible and Incompressible Recirculating Flows by a Non-Iterative Implicit Scheme. *J. Comput. Phys.* **1986**, *62*, 66–82. [https://doi.org/10.1016/0021-9991\(86\)90100-2](https://doi.org/10.1016/0021-9991(86)90100-2).
78. Payri, R.; Ruiz, S.; Gimeno, J.; Martí-Aldaraví, P. Verification of a New CFD Compressible Segregated and Multi-Phase Solver with Different Flux Updates-Equations Sequences. *Appl. Math. Model.* **2015**, *39*, 851–861. <https://doi.org/10.1016/j.apm.2014.07.011>.
79. Dickinson, E.J.F.; Wain, A.J. The Butler-Volmer Equation in Electrochemical Theory: Origins, Value, and Practical Application. *J. Electroanal. Chem.* **2020**, *872*, 114145. <https://doi.org/10.1016/j.jelechem.2020.114145>.
80. Ngandjong, A.C.; Lombardo, T.; Primo, E.N.; Chouchane, M.; Shodiev, A.; Arcelus, O.; Franco, A.A. Investigating Electrode Calendering and Its Impact on Electrochemical Performance by Means of a New Discrete Element Method Model: Towards a Digital Twin of Li-Ion Battery Manufacturing. *J. Power Sources* **2021**, *485*, 229320. <https://doi.org/10.1016/j.jpowsour.2020.229320>.

81. Chandrupatla, T.; Belegundu, A. *Introduction to Finite Elements in Engineering*; Cambridge University Press: Cambridge, UK, 2021; ISBN 9781108882293.
82. Sabat, L.; Kundu, C.K. History of Finite Element Method: A Review. *Recent Dev. Sustain. Infrastruct. Sel. Proc. ICRDSI* **2021**, *2020*, 395–404, ISBN 978-981-15-4577-1.
83. Tsige, D.; Korita, M.; Beyene, A. Deformation Analysis of Cement Modified Soft Clay Soil Using Finite Element Method (FEM). *Heliyon* **2022**, *8*, e09613. <https://doi.org/10.1016/j.heliyon.2022.e09613>.
84. Dickinson, E.J.F.; Ekström, H.; Fontes, E. COMSOL Multiphysics®: Finite Element Software for Electrochemical Analysis. A Mini-Review. *Electrochem. Commun.* **2014**, *40*, 71–74. <https://doi.org/10.1016/j.elecom.2013.12.020>.
85. Goel, V.; Thornton, K. Enabling the Electrochemical Simulation of Li-Ion Battery Electrodes with Anisotropic Tortuosity in COMSOL Multiphysics®. *MethodsX* **2021**, *8*, 101425. <https://doi.org/10.1016/j.mex.2021.101425>.
86. Andreou, E.; Roy, S. Modelling the Scaling-Up of the Nickel Electroforming Process. *Front. Chem. Eng.* **2022**, *4*. <https://doi.org/10.3389/fceng.2022.755725>.
87. Jasak, H. OpenFOAM: Open Source CFD in Research and Industry. *Int. J. Nav. Archit. Ocean Eng.* **2009**, *1*, 89–94. <https://doi.org/10.2478/IJNAOE-2013-0011>.
88. Huang, M.; Weber, N.; Mutschke, G. A Simulation Framework for Electrochemical Processes with Electrolyte Flow. *J. Electrochem. Soc.* **2023**, *170*, 073502. <https://doi.org/10.1149/1945-7111/ace333>.
89. Lee, Y.K. How Complex Systems Get Engaged in Fashion Design Creation: Using Artificial Intelligence. *Think. Ski. Creat.* **2022**, *46*, 101137. <https://doi.org/10.1016/j.tsc.2022.101137>.
90. Särämäkari, N.; Vänskä, A. 'Just Hit a Button!'—Fashion 4.0 Designers as Cyborgs, Experimenting and Designing with Generative Algorithms. *Int. J. Fash. Des. Technol. Educ.* **2022**, *15*, 211–220. <https://doi.org/10.1080/17543266.2021.1991005>.
91. Kallioras, N.A.; Lagaros, N.D. DZAIN: Deep Learning Based Generative Design. *Procedia Manuf.* **2020**, *44*, 591–598. <https://doi.org/10.1016/j.promfg.2020.02.251>.
92. Giurlani, W.; Zangari, G.; Gambinossi, F.; Passaponti, M.; Salvietti, E.; Di Benedetto, F.; Caporali, S.; Innocenti, M. Electroplating for Decorative Applications: Recent Trends in Research and Development. *Coatings* **2018**, *8*, 1–25. <https://doi.org/10.3390/coatings8080260>.
93. Ishizuka, N.; Yamada, T.; Izui, K.; Nishiwaki, S. Topology Optimization for Unifying Deposit Thickness in Electroplating Process. *Struct. Multidiscip. Optim.* **2020**, *62*, 1767–1785. <https://doi.org/10.1007/s00158-020-02574-8>.
94. Yang, G.; Deng, D.; Zhang, Y.; Zhu, Q.; Cai, J. Numerical Optimization of Electrodeposition Thickness Uniformity with Respect to the Layout of Anode and Cathode. *Electrocatalysis* **2021**, *12*, 478–488. <https://doi.org/10.1007/s12678-021-00668-5>.
95. Giurlani, W.; Berretti, E.; Innocenti, M.; Lavacchi, A. Measuring the Thickness of Metal Coatings: A Review of the Methods. *Coatings* **2020**, *10*, 1–36. <https://doi.org/10.3390/coatings10121211>.
96. Italfimet GalvanoTecnica e nuove finiture ISSN 1221-855X. 2020, pp. 234–236. Available online: <https://www.calameo.com/read/006235656c74a61e8e77c> (accessed on 19 March 2024)
97. Luxury Brands Technologies HCS: Homogeneous Coating System. Available online: <https://luxurybrandstechnologies.it/hcs-homogeneous-coating-system/> (accessed on 19 March 2024).
98. Chen, M.; Wu, M.; Lin, C. Application of Indices Cp and Cpk to Improve Quality Control Capability in Clinical Biochemistry Laboratories. *Chin. J. Physiol.* **2014**, *57*, 63–68. <https://doi.org/10.4077/CJP.2014.BAB170>.
99. Mariani, E.; Giurlani, W.; Verrucchi, M.; Dell'Aquila, V.; Lo Nostro, P.; Innocenti, M. Pulse Electroplating of Gold-Nickel Alloys: Morphological and Aesthetic Improvement Compared to DC. *J. Electrochem. Soc.* **2024**, *171*, 012504. <https://doi.org/10.1149/1945-7111/ad1d97>.
100. ISO 9227:2017; Corrosion Tests in Artificial Atmospheres—Salt Spray Tests. International Organization for Standardization: Geneva, Switzerland, 2017.
101. Canda, L.; Heput, T.; Ardelean, E. Methods for Recovering Precious Metals from Industrial Waste. *IOP Conf. Ser. Mater. Sci. Eng.* **2016**, *106*, 012020. <https://doi.org/10.1088/1757-899X/106/1/012020>.
102. Comparini, A.; Del Pace, I.; Giurlani, W.; Emanuele, R.; Verrucchi, M.; Bonechi, M.; Innocenti, M. Electroplating on Al6082 Aluminium: A New Green and Sustainable Approach. *Coatings* **2022**, *13*, 13. <https://doi.org/10.3390/coatings13010013>.
103. Fu, F.; Wang, Q. Removal of Heavy Metal Ions from Wastewaters: A Review. *J. Environ. Manag.* **2011**, *92*, 407–418. <https://doi.org/10.1016/j.jenvman.2010.11.011>.
104. Ani, J.U.; Akpomie, K.G.; Okoro, U.C.; Aneke, L.E.; Onukwuli, O.D.; Ujam, O.T. Potentials of Activated Carbon Produced from Biomass Materials for Sequestration of Dyes, Heavy Metals, and Crude Oil Components from Aqueous Environment. *Appl. Water Sci.* **2020**, *10*, 69. <https://doi.org/10.1007/s13201-020-1149-8>.
105. Habib, S.S.; Naz, S.; Fazio, F.; Cravana, C.; Ullah, M.; Rind, K.H.; Attaullah, S.; Filiciotto, F.; Khayyam, K. Assessment and Bioaccumulation of Heavy Metals in Water, Fish (Wild and Farmed) and Associated Human Health Risk. *Biol. Trace Elem. Res.* **2024**, *202*, 725–735. <https://doi.org/10.1007/s12011-023-03703-2>.
106. Barakat, M.A. New Trends in Removing Heavy Metals from Industrial Wastewater. *Arab. J. Chem.* **2011**, *4*, 361–377. <https://doi.org/10.1016/j.arabjc.2010.07.019>.
107. Babel, S. Low-Cost Adsorbents for Heavy Metals Uptake from Contaminated Water: A Review. *J. Hazard. Mater.* **2003**, *97*, 219–243. [https://doi.org/10.1016/S0304-3894\(02\)00263-7](https://doi.org/10.1016/S0304-3894(02)00263-7).
108. Bragagni, M.; Xhaferraj, L. Copper and Our Sustainable Future. *Esharelife Found.* **2021**. <https://doi.org/10.13140/RG.2.2.26384.53762>.

109. Paulino, A.T.; Minasse, F.A.S.; Guilherme, M.R.; Reis, A.V.; Muniz, E.C.; Nozaki, J. Novel Adsorbent Based on Silkworm Chrysalides for Removal of Heavy Metals from Wastewaters. *J. Colloid Interface Sci.* **2006**, *301*, 479–487. <https://doi.org/10.1016/j.jcis.2006.05.032>.
110. Oyaró, N.; Ogendi, J.; Murago, E.N.; Gitonga, E. The Contents of Pb, Cu, Zn and Cd in Meat in Nairobi, Kenya. *Int. J. Food Agric. Environ.* **2007**, *5*, 119–121.
111. Kania, H.; Saternus, M. Evaluation and Current State of Primary and Secondary Zinc Production—A Review. *Appl. Sci.* **2023**, *13*, 2003. <https://doi.org/10.3390/app13032003>.
112. Cleanmetals SA Nickel. Available online: <http://www.elsametal.com/metals/nickel/> (accessed on 19 March 2024).
113. Borba, C.E.; Guirardello, R.; Silva, E.A.; Veit, M.T.; Tavares, C.R.G. Removal of Nickel(II) Ions from Aqueous Solution by Biosorption in a Fixed Bed Column: Experimental and Theoretical Breakthrough Curves. *Biochem. Eng. J.* **2006**, *30*, 184–191. <https://doi.org/10.1016/j.bej.2006.04.001>.
114. Tomioka, H.; King, T.E.; Schnabel, A. Gold-Induced Pulmonary Disease: Clinical Features, Outcomes, and Differentiation from Rheumatoid Lung Disease. *Pneumologie* **1997**, *51*, 921.
115. Pitzianti, E. Quanto Male Fa Al Pianeta l'estrazione Dell'oro? Available online: <https://www.wired.it/articolo/estrazione-oro-danni-ambiente-inquinamento/> (accessed on 19 March 2024).
116. Khezami, L.; Capart, R. Removal of Chromium(VI) from Aqueous Solution by Activated Carbons: Kinetic and Equilibrium Studies. *J. Hazard. Mater.* **2005**, *123*, 223–231. <https://doi.org/10.1016/j.jhazmat.2005.04.012>.
117. Ripley, E.A.; Redmann, E.R.; Crowder, A.A.; Ariano, T.C.; Corrigan, C.A.; Farmer, R.J.; Jackson, L.M. *Environmental Effects of Mining*; Routledge: London, UK, 2018; ISBN 9780203757147.
118. Earthworks; Oxfam America Dirty Metals—Mining, Communities and the Environment; 2004. Available online: [https://earthworks.org/files/publications/NDG\\_DirtyMetalsReport\\_HR.pdf](https://earthworks.org/files/publications/NDG_DirtyMetalsReport_HR.pdf) (accessed on 4 July 2024).
119. Cui, J.; Forssberg, E. Mechanical Recycling of Waste Electric and Electronic Equipment: A Review. *J. Hazard. Mater.* **2003**, *99*, 243–263. [https://doi.org/10.1016/S0304-3894\(03\)00061-X](https://doi.org/10.1016/S0304-3894(03)00061-X).
120. Lezak, S.; Wilson, C.; Ansar, A.; Bazilian, M. The Case against Gold Mining. *Environ. Res. Lett.* **2023**, *18*, 011001. <https://doi.org/10.1088/1748-9326/ac9f26>.
121. Chen, W.; Hong, J.; Wang, C.; Sun, L.; Zhang, T.; Zhai, Y.; Zhang, Q. Water Footprint Assessment of Gold Refining: Case Study Based on Life Cycle Assessment. *Ecol. Indic.* **2021**, *122*, 107319. <https://doi.org/10.1016/j.ecolind.2020.107319>.
122. Dossou Etui, I.M.; Stylo, M.; Davis, K.; Evers, D.C.; Vera, I.S.; Wood, C.; Burton, M.E.H. Artisanal and Small-Scale Gold Mining and Biodiversity: A Global Literature Review. *Ecotoxicology* **2024**, *33*, 484–504 <https://doi.org/10.1007/s10646-024-02748-w>.
123. Fairtrade Oro Etico: Un Passo Avanti Verso Un Futuro Sostenibile. Available online: <https://www.fairtrade.it/blog/fairtrade/oro-etico-un-passo-avanti-verso-un-futuro-sostenibile/> (accessed on 18 April 2024).
124. Fritz, B.; Peregovich, B.; da Silva Tenório, L.; da Silva Alves, A.C.; Schmidt, M. Mercury and CO<sub>2</sub> Emissions from Artisanal Gold Mining in Brazilian Amazon Rainforest. *Nat. Sustain.* **2023**, *7*, 15–22. <https://doi.org/10.1038/s41893-023-01242-1>.
125. Esdaile, L.J.; Chalker, J.M. The Mercury Problem in Artisanal and Small-Scale Gold Mining. *Chem.—A Eur. J.* **2018**, *24*, 6905–6916. <https://doi.org/10.1002/chem.201704840>.
126. Cheng, Y.; Watari, T.; Seccatore, J.; Nakajima, K.; Nansai, K.; Takaoka, M. A Review of Gold Production, Mercury Consumption, and Emission in Artisanal and Small-Scale Gold Mining (ASGM). *Resour. Policy* **2023**, *81*, 103370. <https://doi.org/10.1016/j.resourpol.2023.103370>.
127. Mook, A.; Overdeest, C. Fairtrade Credentialism: Towards Understanding Certified Producer Organizations' Perceptions of Fairtrade as a Credential. *Globalizations* **2020**, *17*, 110–125. <https://doi.org/10.1080/14747731.2019.1638113>.
128. Oakley, P. Searching for Pure Gold: The Impact of Ethical Gold Sourcing Certification Programmes in the UK and Switzerland. *Environ. Sci. Policy* **2022**, *132*, 101–108. <https://doi.org/10.1016/j.envsci.2022.02.016>.
129. Fairtrade Gold and Precious Metals. Available online: <https://www.fairtrade.net/product/gold> (accessed on 19 March 2024).
130. Bloomfield, M.J.; Manchanda, N. Business, Power, and Private Regulatory Governance: Shaping Subjectivities and Limiting Possibilities in the Gold Supply Chain. *Regul. Gov.* **2024**, *18*, 81–98. <https://doi.org/10.1111/rego.12522>.
131. Kurniawan, T.A.; Chan, G.Y.S.; Lo, W.-H.; Babel, S. Physico-Chemical Treatment Techniques for Wastewater Laden with Heavy Metals. *Chem. Eng. J.* **2006**, *118*, 83–98. <https://doi.org/10.1016/j.cej.2006.01.015>.
132. Babu, B.R.; Bhanu, S.U.; Seeni, M.K. Waste Minimization in Electroplating Industries: A Review. *J. Environ. Sci. Heal. Part C* **2009**, *27*, 155–177. <https://doi.org/10.1080/10590500903124158>.
133. Azmi, A.A.; Jai, J.; Zamanhuri, N.A.; Yahya, A. Precious Metals Recovery from Electroplating Wastewater: A Review. *IOP Conf. Ser. Mater. Sci. Eng.* **2018**, *358*, 012024. <https://doi.org/10.1088/1757-899X/358/1/012024>.
134. Upadhyay, K. Solution for Wastewater Problem Related to Electroplating Industry: An Overview. *J. Ind. Pollut. Control* **2006**, *22*, 59–66.
135. Adhoum, N.; Monser, L.; Bellakhal, N.; Belgaied, J. Treatment of Electroplating Wastewater Containing Cu<sup>2+</sup>, Zn<sup>2+</sup> and Cr(VI) by Electrocoagulation. *J. Hazard. Mater.* **2004**, *112*, 207–213. <https://doi.org/10.1016/j.jhazmat.2004.04.018>.
136. Selpiana, S.; Haryati, S.; Bustan, M.D. Cathode Current Efficiency of Lead Electrowinning in Sulphate Electrolyte. *AIP Conf. Proc.* **2022**, *2391*, 040007. <https://doi.org/10.1063/5.0072429>.
137. Rajoria, S.; Vashishtha, M.; Sangal, V.K. Treatment of Electroplating Industry Wastewater: A Review on the Various Techniques. *Environ. Sci. Pollut. Res.* **2022**, *29*, 72196–72246. <https://doi.org/10.1007/s11356-022-18643-y>.

138. Kim, J.; Yoon, S.; Choi, M.; Min, K.J.; Park, K.Y.; Chon, K.; Bae, S. Metal Ion Recovery from Electrodialysis-Concentrated Plating Wastewater via Pilot-Scale Sequential Electrowinning/Chemical Precipitation. *J. Clean. Prod.* **2022**, *330*, 129879. <https://doi.org/10.1016/j.jclepro.2021.129879>.
139. Janssen, L. The Role of Electrochemistry and Electrochemical Technology in Environmental Protection. *Chem. Eng. J.* **2002**, *85*, 137–146. [https://doi.org/10.1016/S1385-8947\(01\)00218-2](https://doi.org/10.1016/S1385-8947(01)00218-2).
140. Kongsricharoern, N.; Polprasert, C. Electrochemical Precipitation of Chromium (Cr) from an Electroplating Wastewater. *Water Sci. Technol.* **1995**, *31*, 109–117. [https://doi.org/10.1016/0273-1223\(95\)00412-G](https://doi.org/10.1016/0273-1223(95)00412-G).
141. US Environmental Protection Agency (EPA). *Wastewater Technology Fact Sheet Chemical Precipitation—EPA832-F-00-018*; US Environmental Protection Agency (EPA): Washington, DC, USA, 2000.
142. Wang, L.K.; Hung, Y.-T.; Shammass, N.K. *Physicochemical Treatment Processes*; Wang, L.K., Hung, Y.-T., Shammass, N.K., Eds.; Humana Press: Totowa, NJ, USA, 2005; Volume 3, ISBN 978-1-58829-165-3.
143. Shammass, N.K. Coagulation and Flocculation. In *Physicochemical Treatment Processes*; Humana Press: Totowa, NJ, USA, 2005; pp. 103–139.
144. Cheng, R.C.; Liang, S.; Wang, H.; Beuhler, M.D. Enhanced Coagulation for Arsenic Removal. *J. AWWA* **1994**, *86*, 79–90. <https://doi.org/10.1002/j.1551-8833.1994.tb06248.x>.
145. Matis, K.A.; Zouboulis, A.I.; Gallios, G.P.; Erwe, T.; Blöcher, C. Application of Flotation for the Separation of Metal-Loaded Zeolites. *Chemosphere* **2004**, *55*, 65–72. <https://doi.org/10.1016/j.chemosphere.2003.11.030>.
146. Vigneswaran, S.; Ngo, H.H.; Chaudhary, D.S.; Hung, Y.-T. *Physicochemical Treatment Processes for Water Reuse*. In *Physicochemical Treatment Processes*; Humana Press: Totowa, NJ, USA, 2005; pp. 635–676.
147. Wahab Mohammad, A.; Othaman, R.; Hilal, N. Potential Use of Nanofiltration Membranes in Treatment of Industrial Wastewater from Ni-P Electroless Plating. *Desalination* **2004**, *168*, 241–252. <https://doi.org/10.1016/j.desal.2004.07.004>.
148. Bohdziewicz, J.; Bodzek, M.; Wąsik, E. The Application of Reverse Osmosis and Nanofiltration to the Removal of Nitrates from Groundwater. *Desalination* **1999**, *121*, 139–147. [https://doi.org/10.1016/S0011-9164\(99\)00015-6](https://doi.org/10.1016/S0011-9164(99)00015-6).
149. Madaeni, S.; Mansourpanah, Y. COD Removal from Concentrated Wastewater Using Membranes. *Filtr. Sep.* **2003**, *40*, 40–46. [https://doi.org/10.1016/S0015-1882\(03\)00635-9](https://doi.org/10.1016/S0015-1882(03)00635-9).
150. Dąbrowski, A.; Hubicki, Z.; Podkościelny, P.; Robens, E. Selective Removal of the Heavy Metal Ions from Waters and Industrial Wastewaters by Ion-Exchange Method. *Chemosphere* **2004**, *56*, 91–106. <https://doi.org/10.1016/j.chemosphere.2004.03.006>.
151. Yahya, M.A.; Al-Qodah, Z.; Ngah, C.W.Z. Agricultural Bio-Waste Materials as Potential Sustainable Precursors Used for Activated Carbon Production: A Review. *Renew. Sustain. Energy Rev.* **2015**, *46*, 218–235. <https://doi.org/10.1016/j.rser.2015.02.051>.
152. Moreira, S.A.; Melo, D.Q.; de Lima, A.C.A.; Sousa, F.W.; Oliveira, A.G.; Oliveira, A.H.B.; Nascimento, R.F. Removal of Ni<sup>2+</sup>, Cu<sup>2+</sup>, Zn<sup>2+</sup>, Cd<sup>2+</sup> Ions from Aqueous Solutions Using Cashew Peduncle Bagasse as an Eco-Friendly Biosorbent. *Desalin. Water Treat.* **2016**, *57*, 10462–10475. <https://doi.org/10.1080/19443994.2015.1037355>.
153. Cesiulis, H.; Tsyntaru, N. Eco-Friendly Electrowinning for Metals Recovery from Waste Electrical and Electronic Equipment (WEEE). *Coatings* **2023**, *13*, 574. <https://doi.org/10.3390/coatings13030574>.
154. Chen, G. Electrochemical Technologies in Wastewater Treatment. *Sep. Purif. Technol.* **2004**, *38*, 11–41. <https://doi.org/10.1016/j.seppur.2003.10.006>.
155. MikeChE Electrodialysis. Available online: <https://commons.wikimedia.org/wiki/File:Electrodialysis.jpg> (accessed on 19 March 2024).
156. Subbaiah, T.; Mallick, S.; Mishra, K.; Sanjay, K.; Das, R. Electrochemical Precipitation of Nickel Hydroxide. *J. Power Sources* **2002**, *112*, 562–569. [https://doi.org/10.1016/S0378-7753\(02\)00470-6](https://doi.org/10.1016/S0378-7753(02)00470-6).
157. Herrmann, J.-M. Heterogeneous Photocatalysis: Fundamentals and Applications to the Removal of Various Types of Aqueous Pollutants. *Catal. Today* **1999**, *53*, 115–129. [https://doi.org/10.1016/S0920-5861\(99\)00107-8](https://doi.org/10.1016/S0920-5861(99)00107-8).
158. Barakat, M. Removal of Toxic Cyanide and Cu(II) Ions from Water by Illuminated TiO<sub>2</sub> Catalyst. *Appl. Catal. B Environ.* **2004**, *53*, 13–20. <https://doi.org/10.1016/j.apcatb.2004.05.003>.
159. Ibhaddon, A.; Fitzpatrick, P. Heterogeneous Photocatalysis: Recent Advances and Applications. *Catalysts* **2013**, *3*, 189–218. <https://doi.org/10.3390/catal3010189>.

**Disclaimer/Publisher’s Note:** The statements, opinions and data contained in all publications are solely those of the individual author(s) and contributor(s) and not of MDPI and/or the editor(s). MDPI and/or the editor(s) disclaim responsibility for any injury to people or property resulting from any ideas, methods, instructions or products referred to in the content.