



UNIVERSITÀ  
DEGLI STUDI  
FIRENZE

# FLORE

## Repository istituzionale dell'Università degli Studi di Firenze

### **Safety analysis of multimodal transportations corridors.**

Questa è la Versione finale referata (Post print/Accepted manuscript) della seguente pubblicazione:

*Original Citation:*

Safety analysis of multimodal transportations corridors / L. Domenichini; F. La Torre Bellardoni; G. Giordano. - STAMPA. - (2004), pp. 0-0. (Intervento presentato al convegno 2n International Congress SIIV "New technologies and modeling tools for roads". tenutosi a Firenze, Italia nel 27-29 Ottobre 2004).

*Availability:*

This version is available at: 2158/238343 since:

*Terms of use:*

Open Access

La pubblicazione è resa disponibile sotto le norme e i termini della licenza di deposito, secondo quanto stabilito dalla Policy per l'accesso aperto dell'Università degli Studi di Firenze (<https://www.sba.unifi.it/upload/policy-oa-2016-1.pdf>)

*Publisher copyright claim:*

(Article begins on next page)

# **SAFETY ANALYSIS OF MULTIMODAL TRANSPORTATION CORRIDORS**

**Lorenzo Domenichini**  
Full Professor – University of Firenze - Italy

**Francesca La Torre**  
Associate Professor – University of Firenze - Italy

**Giampiero Giordano**  
Cepav Uno – Consorzio Eni per l'Alta Velocità

## **SYNOPSIS**

Setting the present model of mobility to conditions of higher sustainability and safety is a widely shared statement at both national and international level. This requires the development of integrated strategies for safety and environment able to control the social, economic and environmental impact produced by the main transportation infrastructures.

The identification of multimodal corridors where to locate main transportation infrastructures allows to minimise land consumption but introduce safety problems which need to be carefully analysed. These problems were faced during the construction of the Italian high speed railway network which, for long sections, is located close to the main highway network. The possible invasion of the railway track by vehicles running off the highway roadway represents a risk which has to be quantified and minimised if necessary. Therefore, a dedicated safety study was performed to evaluate the probability of such events and to identify the mitigation measures required to reduce the risk under acceptable levels.

The essential performance requirement for the study consists in the definition of the allowed probability of occurrence of the critical event (which leads, in turn, to a "return time" of a given event), which depends on the railway operational characteristics.

The actual probability of the event has to be identified as a function of the highway operative conditions (amount of traffic, traffic composition, actuated speeds, accident rate) and the physical characteristics of the site (distance between railway and highway, highway cross section, relative elevation of the railroad and highway, height and slope of the embankments, cross section design of the area existing between roadway and railroad).

To evaluate the probability that a vehicle running off the highway has enough energy to reach the railroad, a cinematic and dynamic model was developed. It includes two different analysis conditions: the vehicle loses the contact with the ground (ballistic problem) and the vehicle rolls along the off road surfaces. The model allows also to take care of possible surmountable obstacles (protection embankments) built in the area between the two infrastructures.

# SAFETY ANALYSIS OF MULTIMODAL TRANSPORTATION CORRIDORS

## INTRODUCTION

The increasing need to reduce the impact of infrastructures in the surrounding environment and to minimise land consumption has led in the last years to the design of high speed railways close by the existing highways in order to realise a unique “multimodal corridor”.

This new design approach has raised a new issue related to the “highway-railway interaction” which has never been tackled in a systematic way before. Given the fact that the extension of these multimodal corridors can be of hundreds of kilometres there is clearly a need to define procedures to identify the situations where there is the potential for an invasion of the railway track from an errant vehicle running off the highway and how to protect the railway in these situations.

One of the key issues of this problem is related to the fact that the protection of the railway track should be generally achieved independently of the highway maintenance procedures and strategies and it was therefore deemed necessary to study the interference conditions independently of the possibility of having road restraint systems at the highway edge (even though these might be required by national standards), mainly in the cases where an existing highway is considered.

For this aim a simulation model has been developed in order to evaluate:

- if there is a possible interference between a vehicle running off the highway and the railway track;
- the protection systems to be applied when there is a potential interference

This paper will describe the models which have been set up for this purpose and the specific application for the identification of the situations where there can be an interference between the errant vehicle and the railroad.

## DEFINITION OF THE REFERENCE ACCIDENT CONDITIONS

Accident conditions on a main road arterial can be different in terms of vehicle type and mass, vehicle speed, runoff angle and probability of occurrence.

For the evaluation of interaction between the highway and the railway a “reference accident condition” has to be defined in terms of:

- the characteristics of the vehicle considered (geometry and mass);
- the lane from which the vehicle starts losing control;
- the travelling speed (in the moment when the vehicle starts losing control).

Given the fact that all these parameters are variable from one accident to another the definition of a reference condition needs to be tackled with a probabilistic approach. This means that the probability that a **given vehicle** is involved in a runoff accident from a **given lane** and with a **speed not lower than a given value** over a **given time period** has to be defined.

The procedure proposed in this study to tackle this issue can be described as follows:

- define the probability that a given type of vehicle can be involved in a runoff accident;
- define the probability that a vehicle of a given class loses control from a given lane;
- define the probability that the speed of a vehicle of a given class travelling in a given lane is equal to or above a given value.

The first issue is therefore the definition of the “vehicle types”. For the purpose of this study 8 different classes have been defined combining the usually available traffic and accident database classifications. For each class the geometric and mass characteristics have been defined considering the EN 1317-2 standard [1] on crash tests over safety barriers and the Italian Road code [2] as shown in Table 1.

Table 1: characterisation of the different vehicle classes

Vehicle Length (L)	L<= 5 m	5<L<=10 m				L>10			
Length sub-classes	< 5	5-7.5	7.5-8.5	8.5-10	8.5-10	10-12		12-15	>15
Type of vehicle	Passenger car	Light Truck (2 axles)			Heavy Trucks (3 axles)		buses	Semitrailers and tractor-trailers	
Coding of vehicle type	<b>C1</b>	<b>C2</b>	<b>C31</b>	<b>C32</b>	<b>C41</b>	<b>C42</b>	<b>C7</b>	<b>C5</b>	<b>C6</b>
Mass (kg)	1500	6000	13000	13000	16000	16000	13000	26000	38000
centre of gravity height	0.53	1.5	1.5	1.5	1.5	1.5	1.4	1.9	1.9
vehicle width	1.5	2	2	2	2	2	2	2	2

For the definition of an accident probability for a given type of vehicle (part “a” of the procedure) an accident analysis has to be conducted on the site where the model is to be applied to identify the events that can be related to runoff problems (vehicles which actually runoff the road section or vehicles that hit the barriers on the right side of the carriageway). This analysis should cover a period of at least 4-5 years to collect a significant number of events.

For each vehicle type an accident rate can be defined, according to the Italian standard for the classification of existing roads [3], by means of Eq. 1:

$$AR_C = \frac{\sum_t N_{t,C} \cdot 10^8}{365 \cdot \sum_t \sum_i (AADT_{t,i} \cdot L_i)} \quad [accidents/100 \text{ millions of vehciles for km}] \quad \text{Eq. 1}$$

where:

$N_{t,C}$  is the number of accidents of the vehicle type “C” occurred over the year  $t$

$AADT_{t,i}$  is the annual average daily traffic in the year  $t$  in the highway segment  $i$  (which is characterised by a constant traffic)

$L_i$  is the length of highway segment  $i$  (in km).

The probability that a given type of vehicle will be involved in a runoff accident in one year ( $P_{AC}$ ) can therefore be defined as:

$$P_{AC} (\%) = AR_C \cdot LT \cdot 100 \quad \text{Eq. 2}$$

where:

$LT$  is the total length travelled by all the vehicles over the analysed highway portion in 1 year (in 100 millions of km) defined as:

$$LT = \sum_i (AADT_i \cdot 365 \cdot L_i) \cdot 10^{-8}$$

To define the probability that a vehicle of a given type ( $C$ ) will loose control from a given lane (part “b” of the procedure) it has been assumed that this is equal to the probability that the vehicle will be travelling in the same lane ( $P_{LC}$ ). The values of  $P_{LC}$  for the different lanes and different vehicle types can be determined based on the actual traffic data, in case of an existing road section, as the ratio of the number of vehicles of a given class travelled in the lane over the total number of vehicles of the same class travelling in the monitored section as indicated in Eq. 3.

$$P_{CL} = \frac{\text{number of vehicles of the class } C \text{ travelling in lane } L}{\text{totale number of vehicles of the class } C \text{ travelling in the section}} \cdot 100 \quad \text{Eq. 3}$$

The latter term that needs to be determined (part “c” of the procedure) is the probability that the vehicle speed is equal to or above a given value. Again the assumption that the distribution of the speed of the vehicles running off is equal to the distribution of all the travelling vehicles has been made and therefore the probability of having a vehicle running at a speed equal or above a given speed  $V$  can be calculated knowing the mean ( $V_m$ ) and standard deviation ( $\sigma_V$ ) of the distribution. Considering that the speed distribution is

different for each vehicle class and travelling lane the probability that one of the vehicles of a given class ( $C$ ) actually travelling in a given lane ( $L$ ) runs at a speed equal or above a given speed ( $V$ ) can be calculated by means of Eq. 4 [4]

$$P_{CV} = \left( 1 - \frac{1}{\sqrt{2 \cdot \pi}} \cdot \int_{-\infty}^x e^{-\frac{1}{2} \xi^2} d\xi \right) \cdot 100 \quad \text{Eq. 4}$$

where:

$$x = \frac{V - V_{m\_C\_L}}{\sigma_{V\_C\_L}}$$

The overall probability that there will be a vehicle of a given class “ $C$ ” will runoff from lane “ $L$ ” at a speed equal or above “ $V$ ” can then be defined as:

$$P_{ACVL} = P_{CA} \cdot P_{CL} \cdot P_{CV} \quad \text{Eq. 5}$$

For design purpose the best indicator is the “return time” of a given event which can be defined as the time (in years) required to have a probability of occurrence equal to 1.

This means that the return time ( $RT$ ) associated with the event of a vehicle of a given class “ $C$ ” running off from lane “ $L$ ” at a speed equal or above “ $V$ ” can be defined as:

$$RT_{ACVL} = \frac{1}{P_{ACVL}} \quad \text{Eq. 6}$$

## THE SIMULATION TOOL

The evaluation of the behaviour of a vehicle which runs off the highway has been modelled considering two different phases:

- on the road behaviour;
- off-road behaviour.

The first phase of the runoff covers the period between the time the vehicle loses control (diverging from its lane) and the time it reaches the road edge.

The outputs of the simulation in this first phase are the speed at the roadway edge and the runoff angle which are then used as an input for the simulation in the off-road phase.

The second phase has been modelled with two different tools depending if the highway and the railway are very close and the vehicle running off can “fly” over the railway or if the distance is such that the vehicle will travel a certain distance on the embankments and on terrain between the two infrastructures.

In the first type of runoff, which likely occurs when both the highway and the railway are supported by retaining walls and run very close to each other, the heavy vehicles runoffs can result as the most critical situations while the passenger car runoff is the most critical situation for the other runoff type which is typical of most of the sections of the multimodal corridors.

### On the road behaviour

This phase of the simulation is aimed at defining the runoff speed and angle at the roadway edge which serve as the basis for the off road simulation.

Currently no statistical data are available to estimate these variables from actually occurred accidents referred to the Italian Motorways. There are some studies world-wide, the most referenced of which has been conducted by Mak, Sicking and Ross [5] but it is based on the US network which is characterised by

extremely different traffic flow conditions. As an example it can be considered that the average run-off speed on a freeway, according to these authors, is 70 km/h which, on Italian Motorways is a very unlikely speed, especially when three lane carriageways are considered, as also shown later in this paper.

For this reason a specific mathematical model has been set up based on the following assumptions:

- the driver losing control of the vehicle doesn't apply any breaking force;
- the vehicle reaches the road edge by means of a parabolic trajectory, as shown in Figure 1.

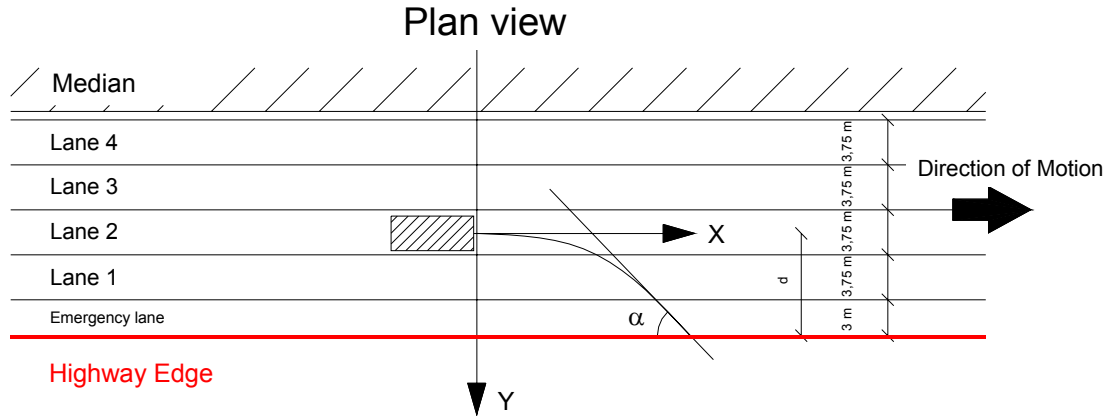

Figure 1: schematisation of the trajectory of the running off vehicle on the carriageway

The equation of the run off trajectory can therefore be defined as:

$$y = a \cdot x^2 \tag{Eq. 7}$$

where  $y'' = \frac{1}{R(x=0)} = 2a$  which means the trajectory can be defined as

$$y = \frac{1}{2 \cdot R(x=0)} \cdot x^2 \tag{Eq. 8}$$

and  $R(x=0)$  is the radius of curvature in the section where the vehicle starts to diverge from the road alignment.

The runoff angle ( $\alpha$ ), which is the angle between the trajectory and the road edge, can therefore be calculated as :

$$\alpha = \arctan \left( \sqrt{\frac{2 \cdot d}{R(x=0)}} \right) \tag{Eq. 9}$$

where:

$d$  is the distance between the point where the vehicle starts to diverge from its nominal trajectory ( $x=0$ ) and the road edge.

To completely define the runoff trajectory the curvature in the point where the trajectory diverges from the road alignment has to be defined. As it can be seen from Eq. 9 the most critical situation occurs when the  $R(x=0)$  value reaches its minimum (which leads to the maximum value of the runoff angle).

The limiting conditions for defining the  $R(x=0)$  value have been set considering that the maximum possible curvature (i.e. minimum radius) is limited by:

- the available friction over which the vehicle starts sliding (equilibrium of lateral forces);
- the roll-over of the vehicle (equilibrium of moments).

This can be therefore written as:

$$R(x=0) = \max \left\{ \begin{array}{l} R_{\min\_slide} \\ R_{\min\_rollover} \end{array} \right\} \quad \text{Eq. 10}$$

where:

$R_{\min\_slide}$  is the minimum radius over which the required side friction for the manoeuvre is higher than the available one;

$R_{\min\_rollover}$  is the minimum radius over which the side force applied to the centre of gravity of the vehicle can cause a rollover.

The slide limiting radius can be calculated based on the side force equilibrium equation as:

$$R_{\min\_slide} = \frac{v^2}{g \cdot f_{t\_max}} \quad \text{Eq. 11}$$

where:

$v$  is the vehicle speed (in m/s);

$g$  is the gravity acceleration (in  $\text{m/s}^2$ );

$f_{t\_max}$  is the maximum available side friction coefficient for the given motion conditions

The rollover limiting radius can be calculated based on the moment equilibrium equation as:

$$R_{\min\_rollover} = \frac{2 \cdot v^2 \cdot h_G}{g \cdot b_r} \quad \text{Eq. 12}$$

where:

$h_G$  is the height of the centre of gravity of the considered vehicle

$b_r$  is the width of the considered vehicle (distance between the wheels)

For calculating the sliding limiting conditions the major problem is related to the definition of the friction coefficient.

It is well known that the available friction depends on several parameters, namely:

- pavement surface characteristics (micro and macro texture);
- condition at the interface between tyre and pavement (the major difference is between wet and dry conditions);
- vehicle speed;
- tyre type and thread depth;
- yaw angle.

In road design the most dangerous condition is considered to be a wet pavements with low friction wearing courses but in this case a higher friction value (i.e. a dry surface) will lead to a lower radius of curvature and therefore to a higher runoff angle, which is more critical. The model proposed has therefore been developed considering dry friction values.

It is well known from the literature [6] that vehicle speed effect becomes extremely low when dry pavements are considered as well as tyre thread depth effects and the greatest effect is therefore given by the yaw angle.

For specific applications a side friction Vs. yaw angle curve could be measured with a commercial tyre on the dry surface but there are only a very limited number of measuring devices world wide capable of measuring side forces with variable yaw angles.

In the EU Funded VERT Project the BV-12 device has been implemented by VTI in order to conduct such type of measurements [7] and an extensive measurement campaign has been conducted on a pavement with a high macrotecture (Mean Texture Depth of 0.96 mm) with different new tyres at the speed of 80 km/h.

In Figure 2 the side friction Vs yaw angle curves are shown for different tyres (all season/winter) and different tyre widths (185 to 225). As it can be seen the curves are quite close to each other, especially for low yaw angles. If only the all season tyres are considered the variability is almost irrelevant over all the yaw angles. Given the fact that the most critical situation is, as said before, the highest friction curve the all season 225 tyre has been considered as a reference.

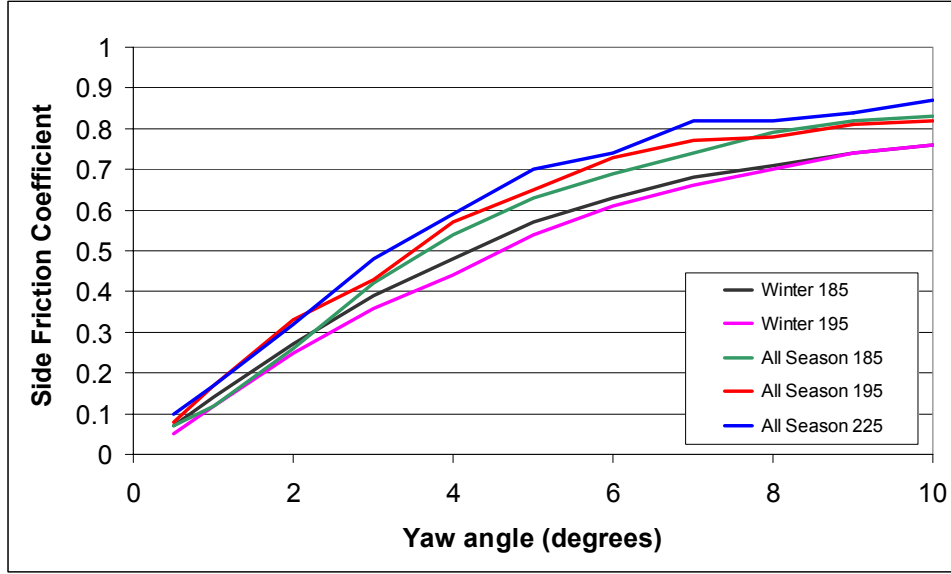

Figure 2: side friction coefficient Vs yaw angle for different tyres from the VERT database.

As far as the yaw angle is concerned there is no close form to derive the actual yaw angle which characterises a given manoeuvre. The application of the simulation tool developed in the VERT project to 284 different bending manoeuvres has lead to following considerations [8].

- the vast majority of the manoeuvres (82%) resulted in **a yaw angle lower than 1°** (233 over 284 simulations);
- 16.5% of the simulations were characterised by **yaw angles between 1° and 5°**;
- only 1.4% of the simulations have reached angles **between 5° and 10° still maintaining the vehicle control**;
- loss of vehicle control has been reached in all the situations with **higher values of degree angles**.

Given these indications, the **5° yaw angle was considered** as the highest value below which the vehicle can still be controlled while for higher values the probability of maintaining a given trajectory is very low and the vehicle starts sliding or yawing. According to the VERT dry friction data shown in Figure 2 this results in considering a friction coefficient value of 0.72.

Once the  $R(x=0)$ , and therefore the run-off trajectory, has been defined, the speed at the road edge can be estimated by considering the amount of energy which is dissipated between the time the driver loses control and when the vehicle reaches the roadway edge. The main assumptions are that the driver doesn't brake and that there are no impacts (which means that no major damages occur on the vehicle).

The different dissipation components ( $dL$ , in joules) which have been considered within a given space interval " $ds$ , in meters" are:

- the energy dissipated by the contact forces between the tyre and the pavement ( $dL_f$ );
- the energy dissipated by the aerodynamic resistance ( $dL_a$ );
- the energy dissipated by the engine resistance ( $dL_m$ ).

as indicated in the following equations.

$$dL_f = m \cdot \frac{v(s)^2}{R} \cdot \sin(\varphi(v(s))) \cdot ds \quad \text{Eq. 13}$$

$$dL_a = \frac{1}{2} \cdot \rho \cdot C_x \cdot S \cdot v(s)^2 \cdot ds \quad \text{Eq. 14}$$

$$dL_m = k \cdot v(s) \cdot 3.6 \cdot m \cdot ds \quad \text{Eq. 15}$$

where:



- $\varphi$  is the yaw angle which varies, during the runoff, due to the fact that both the speed and the radius of the curve reduce along the runoff trajectory. This is back-calculated from the friction Vs. yaw angle curve knowing the friction coefficient required for the side forces equilibrium in each location;
- $m$  is the vehicle mass [kg];
- $\rho$  is the air density in standard conditions [kg/m<sup>3</sup>];
- $C_x$  is the aerodynamic resistance coefficient;
- $S$  is the surface of the section opposed to the vehicle motion [m<sup>2</sup>];
- $k$  is a factor which characterises the engine resistance that can be set in 0.07 for regular fuel passenger cars and 0.1 for diesel trucks.

The speed ( $v$ ) at a given location ( $s_i$ ) is defined as a function of the speed at the previous location ( $s_{i-1}=s_i-ds$ ) by means of Eq. 16.

$$v(s_i) = \sqrt{\frac{2 \cdot \left( \left( \frac{1}{2} \cdot m \cdot v(s_{i-1})^2 \right) - dL_f - dL_a - dL_m \right)}{m}} \quad \text{Eq. 16}$$

The total energy dissipated between the point where the vehicle leaves the nominal trajectory and when it reaches the road edge (the length of which is defined as  $S_p$ ) can therefore be estimated by means of Eq. 17.

$$L = \int_0^{S_p} \left( \left( m \cdot \frac{v(s)^2}{R} \cdot \sin(\varphi(v(s))) \right) + \left( \frac{1}{2} \cdot \rho \cdot C_x \cdot S \cdot v(s)^2 \right) + (k \cdot v(s) \cdot 3.6 \cdot m) \right) \cdot dS \quad \text{Eq. 17}$$

## OFF ROAD BEHAVIOUR

### Runoff ballistic model for close sections

When the highway and the railway are extremely close to each other (in some instances these can be less than 10 m apart) the vehicle running off the road section can “land” over the railway.

To evaluate where this situation can occur a model has been developed based on a “ballistic” approach and aimed at defining the distance at which the vehicle will not reach the railroad track, for a given height of the roadway and of the railway itself. The same model enables to define the minimum height required for the railway retaining wall to protect the railroad for a given cross distance and highway elevation.

For this evaluation the vehicle is considered as a point (located in the centre of gravity of the vehicle) that leaves the ground at a given speed and with a given planing angle (which is the angle between the trajectory and an ideal horizontal plane).

The equation of the trajectory of the centre of gravity with respect to the road pavement can therefore be written as:

$$z = -x^2 \cdot \frac{g}{2 \cdot V^2 \cdot \cos^2 \vartheta} + x \cdot \text{tg} \vartheta + z_G \quad \text{Eq. 18}$$

with:

$g$ = gravity acceleration (m/s<sup>2</sup>);

$V$ = vehicle speed (m/s);

$\vartheta$  = planing angle;

$z_G$  = height of the centre of gravity of the vehicle over the road pavement before the vehicle leaves the road surface.

As indicated earlier this describes the trajectory of the centre of gravity. For design applications it has to be considered that if the impact occurs with the HGV centre of gravity at the height of the edge of the retaining wall the goods carried by the truck remain above the wall and can fall over the railroad track.

The minimum height of the edge of the railway section should therefore be higher than the point calculated by means of Eq. 18 of a value ( $\Delta Z$ ) which could be set in approximately 2 m, considering a total height of the vehicle of 4 m and the centre of gravity at 1.9 m from the road surface, as shown in Figure 3.

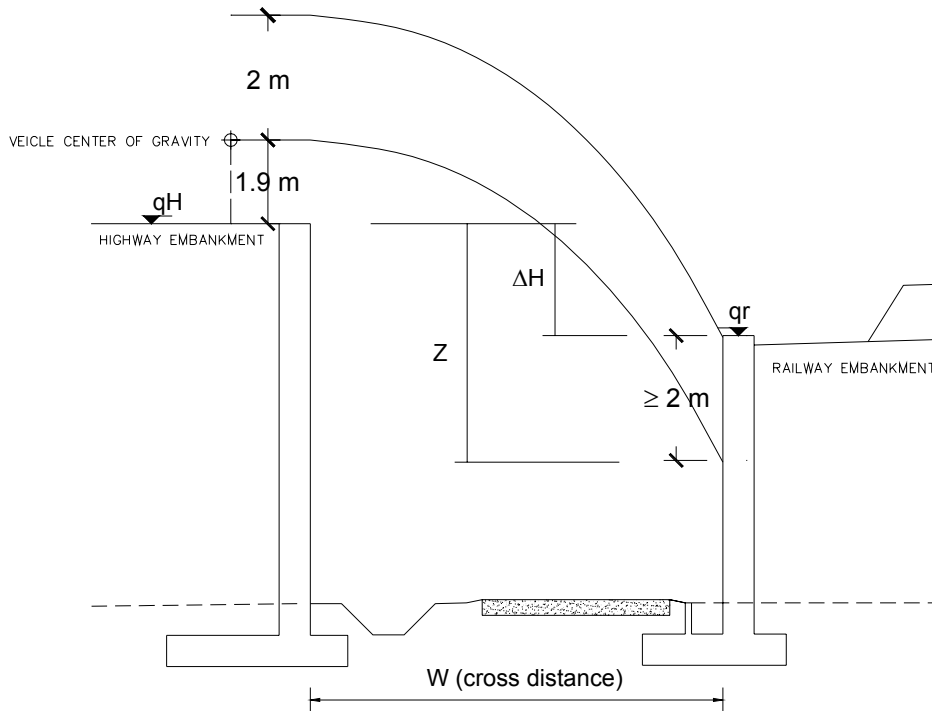

Figure 3: schematisation of the runoff situation in the close sections configuration (ballistic problem)

## Off road dynamic model for aside sections

This section of the off road model is based on the analysis of the behaviour of a vehicle (which can be a passenger car, a single unit truck or a semi-trailer) travelling along a given path with an initial speed equal to the one calculated at the road edge as described earlier.

The dynamic model developed for the analysis is a multibody system where a set of springs and dampers are used to connect the vehicle body to the axles and the wheels to the ground, as shown in Figure 4 referred, as an example, to the semi-trailer heavy vehicle. In this specific case a bi-directional connection system (again obtained coupling in parallel a spring and a damper) have been included to account for the forces transmitted between the two bodies of the vehicle.

When the height of the highway embankment is not null the model also considers the loss of contact with the ground in the first part of the runoff implementing the ballistic approach described earlier.

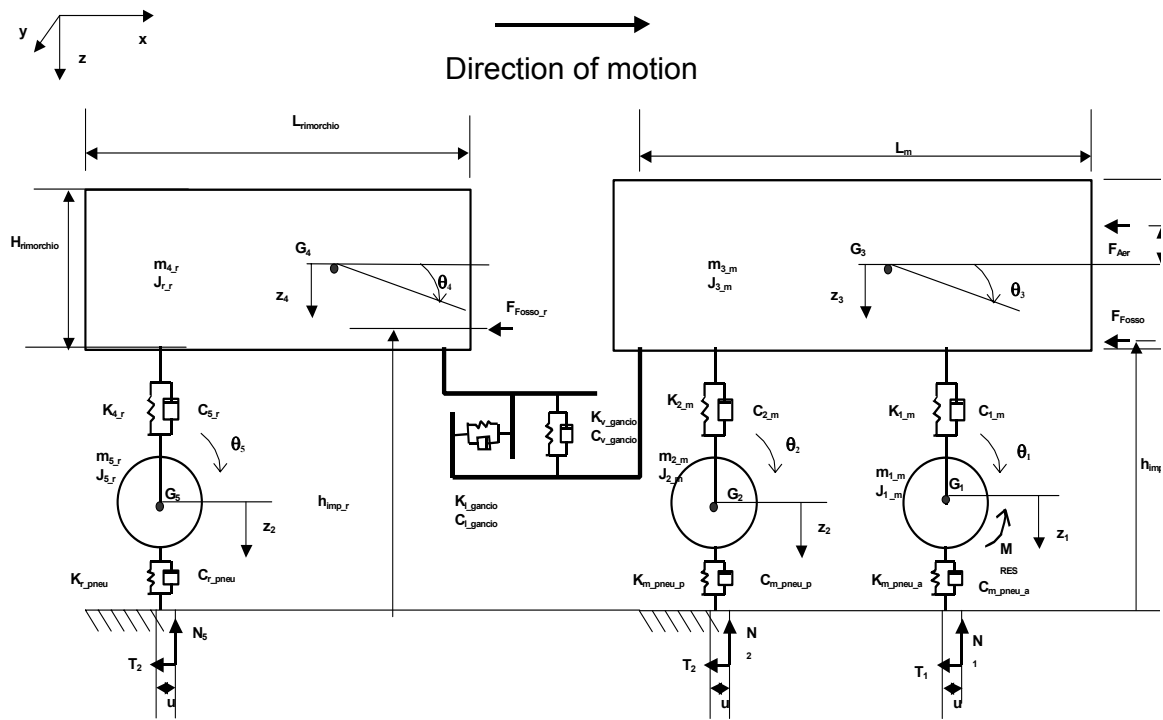

Figure 4: schematisation of the vehicle model used for the off road simulation

The runoff path has then be defined considering the configuration of the area between the highway and the railway (defined, for the purpose of this study, as “interposed area”) described in Figure 5 and in Figure 6 where the first represents the standard configuration while the second represents the situation where an embankment has been realised in the interposed area to protect the railway against the vehicles running off the highway.

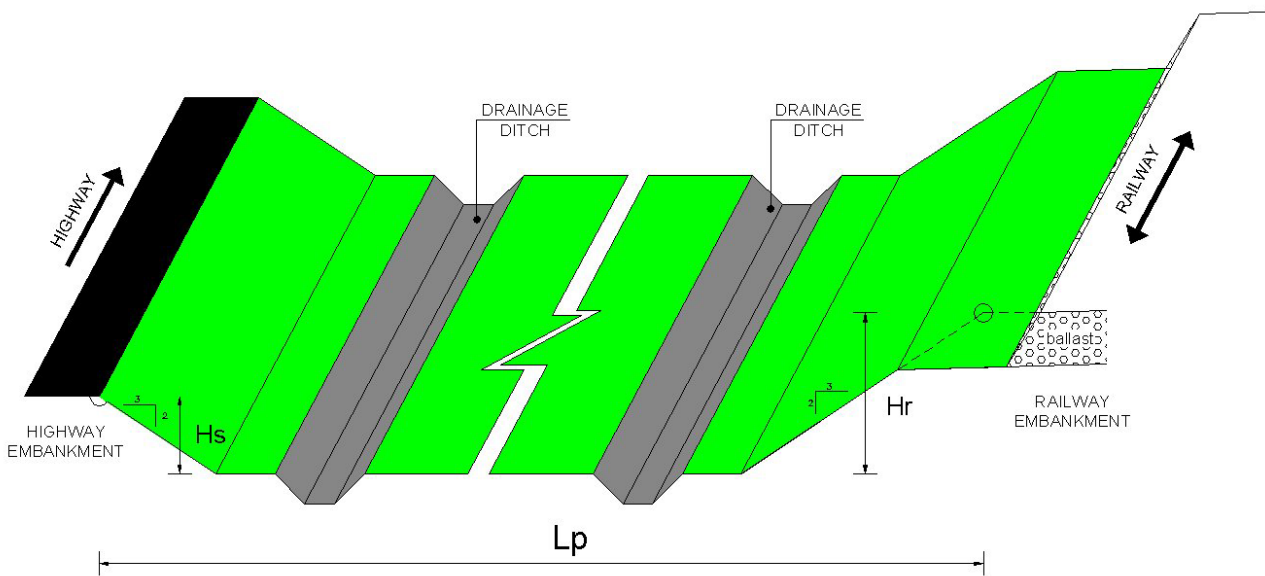

Figure 5: description of the area between the highway and the railway in standard conditions.

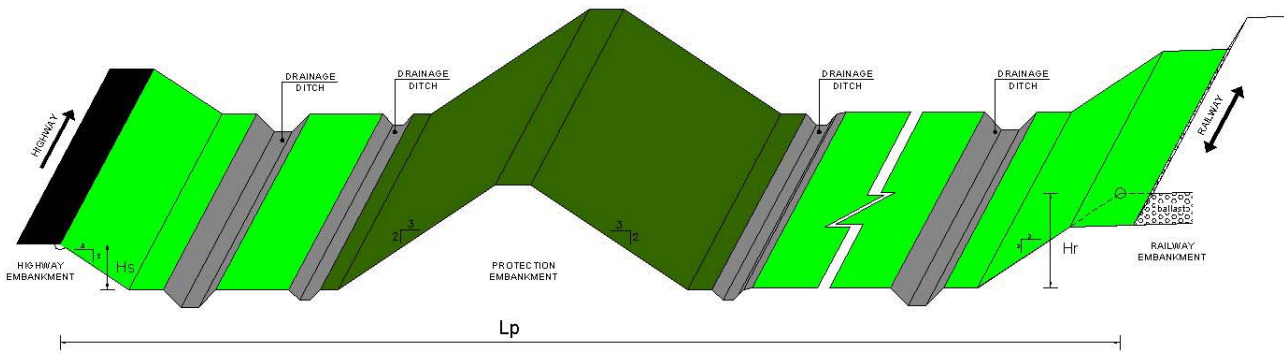

Figure 6: description of the area between the highway and the railway with a protection embankment.

With this schematisation the forces acting on the system are:

- the weight;
- the tyre/ground rolling resistance;
- the aerodynamic force;
- the engine resistance;
- the impulse force associated with the impact against the drainage ditch.

The aerodynamic force and the engine resistance have been calculated with the same approach already described with reference to the behaviour “on the road” while the effect of the weight, the tyre/ground rolling resistance and the impact against the drainage ditch required specific considerations.

#### *The effect of the vehicle weight*

The weight of the vehicle is considered as a parameter for most of the acting forces (such as the tyre/ground resistance and the impulse force generated by the impact against the ditch) but, given the configuration of the interposed area this has also a direct effect on changing the trajectory of the vehicle while running over the sides of the highway and railway embankments. This is due to the fact that when the vehicle is travelling over the side of the embankment with a given slope a component of the weight acts in a direction perpendicular to the instantaneous trajectory and this will induce the vehicle to turn in the downhill direction.

The model proposed in [10], which was developed to evaluate the trajectory of a vehicle in a road section with a given cross fall without side friction, has been adapted in the model proposed in this paper to account for the tyre-ground resistance.

In Figure 7 a detail of the trajectory of a vehicle running uphill on the railway embankment is shown as an example. As it can be seen the effect of the side component of the weight is the redirection of the vehicle with a reduction of the angle between the trajectory and the railway alignment (which tend to become parallel). On the highway embankment the opposite effect is found with the runoff angle that tends to increase but given the fact that the speed is much higher when the vehicle travels over the highway embankment this effect is much more limited but still taken into consideration in the model.

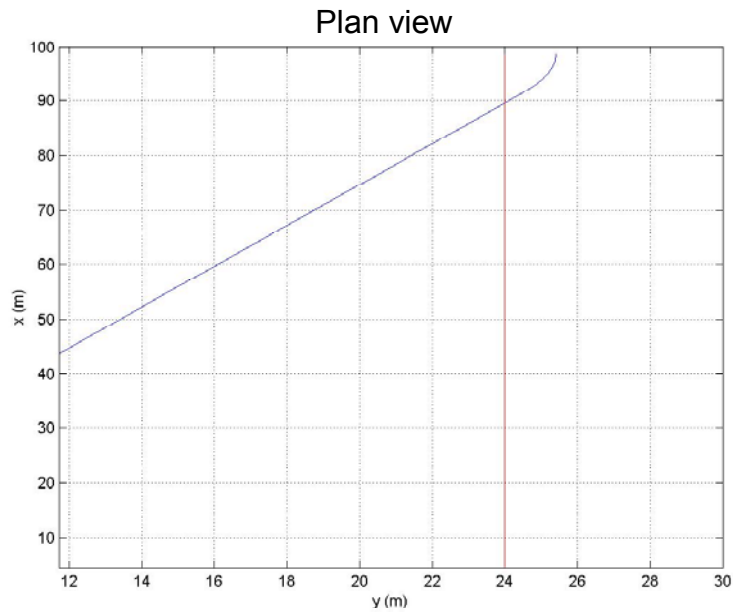

Figure 7: detail of the runoff path uphill on the railway embankment

*The tyre/ground rolling resistance*

When modelling off-road problems the tyre/ground rolling resistance is one of the most important factors.

The phenomenon that leads to a rolling resistance is associated with the fact that the vertical force ( $N$ ) applied by the wheel to the ground deforms the surface and the reaction of the ground ( $R_n$ ) is not applied in the centre of the wheel axle but is shifted forward of a quantity “ $u$ ” as shown in Figure 8 and this induces a resistance to the vehicle motion.

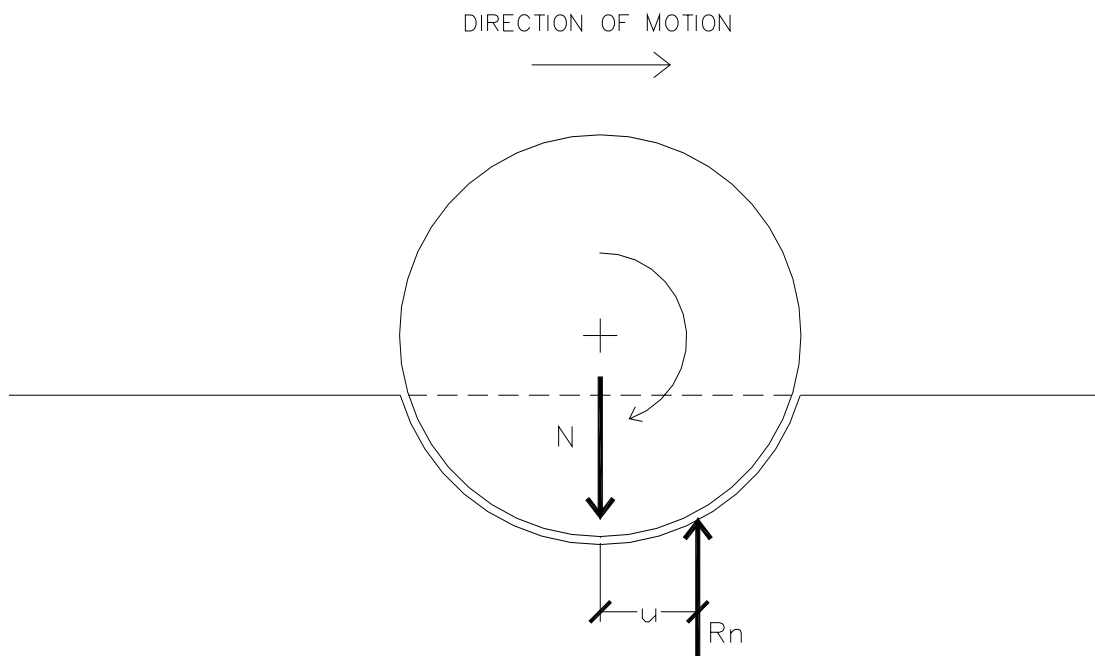

Figure 8: schematisation of the wheel/ground interaction

The major problem is the definition of the offset of the forces ( $u$ ) which strongly depends on the type and compaction of the ground terrain. In road engineering such issue is tackled when dealing with highways emergency escape ramps. The AASHTO Guide for the geometric design of highways and streets [11] considers the rolling resistance ( $R_r$ ) as an horizontal force proportional to the applied vertical load as indicated in Eq. 19:

$$Rr = \mu \cdot P$$

Eq. 19

where:

$P$  is the applied vertical load;

$\mu$  is a coefficient which depends from the rolling surface characteristics which ranges typically from 0.01 (for a compacted concrete surface) to 0.25 (to a gravel terrain).

The proposed model is based on the definition of the offset of the vertical reaction instead than on the definition of a rolling resistance coefficient but the “u” value has been calibrated so to provide rolling resistances comparable with the AASHTO equation referred to a gravel terrain. This value can be modified in the simulation tool to account for different types of off-road ground surfaces.

*The impulse force associated with the impact against the drainage ditch.*

When the wheels travel over the drainage ditch there is an impact against the side of the ditch which produces an energy dissipation. The impulse force can be back-calculated considering the energy dissipation which is typically related to the geometry of the ditch and the radius of the wheel. For this calculation the elastic response of the tyres to the deformation induced by the ditch side has been set to 0.8 which is a typical literature value.

## OUTPUT OF THE SIMULATION MODEL

The model developed in this study allows to define the trajectory of a vehicle running of a given road section (as shown in the example of Figure 9) and therefore the maximum distance from the highway edge reached by the errant vehicle, measured perpendicular to the highway direction ( $L_p$ ).

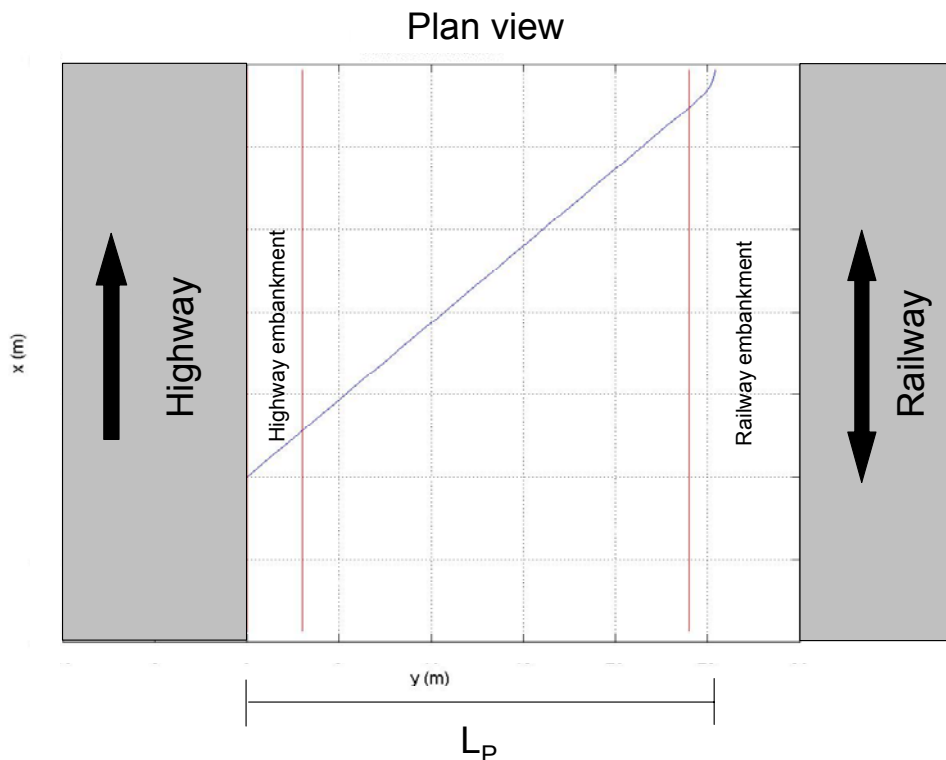

Figure 9: example of plan view of the runoff trajectory

Additional useful indications which can be derived from the simulation tool concern the speed of vehicle along the runoff path, as shown in Figure 10 where the errant vehicle speed has been represented towards the cross distance (measured perpendicular to the highway direction). The example of Figure 10 highlights

the effect of the impact against the drainage ditch which induces a relevant reduction in the vehicle speed at the moment of the two impacts (front and rear wheels) but no rolling resistance during the time when the vehicle travels over it.

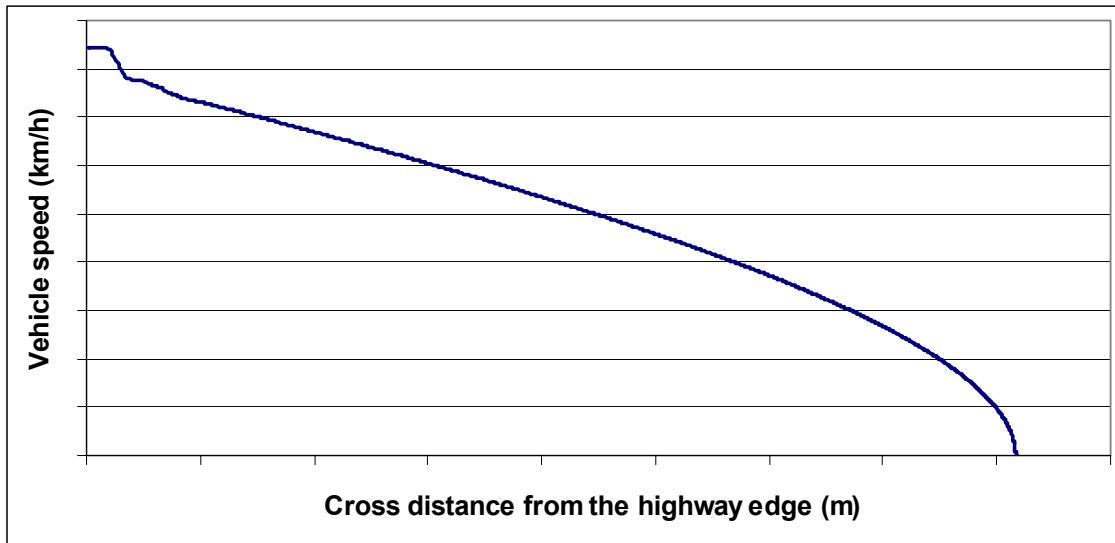

Figure 10: example of speed Vs cross distance diagram

In summary the input variables for the definition of the runoff conditions are:

- the vehicle type (passenger car, single unit truck, semi-trailer);
- the speed and runoff angle at the edge of the highway;
- the height and slope of the highway embankment;
- the height and slope of the railway embankment;
- the configuration of the interposed area (considering also the eventual protection embankment).

## APPLICATION AND SENSITIVITY ANALYSIS OF THE MODEL

The model developed in this study has been applied to a 130 km section of highway where the railway runs almost parallel to it with a cross distance ranging from less than 10 to more than 100 m.

The first objectives of this application was the definition of the situations where the railway is potentially not interested by a runoff from the highway (“self-protected” configuration).

This situation can be achieved when:

- the distance between the railway and the highway is larger than the  $L_p$  value calculated by means of the model described earlier;
- the distance is shorter but the railway embankment is supported by a retaining wall tall enough to protect the railway from the possible invasion from an HGV impact;
- the railway is very close to the highway but the height of the railway retaining wall is such that the vehicle running off the highway shouldn't cause an invasion of the railroad track.

For this application the first issue was the identification of the reference accident condition which has been defined based on the following data:

- Annual Average Daily Traffic (AADT);
- hourly distribution of traffic divided in 3 vehicle classes (according to the vehicle length) over a 1 year period;
- 3 days monitoring of traffic flow with speed and length recorded for each vehicle;
- accident database covering the period 1997 – 2001 where each single accident involving the carriageway right edge is characterised in terms of type of vehicles involved.

Based on this data it was possible to define, for each vehicle type, the following parameters required for the application of the model:

- accident rate specific of each given class ( $P_{CA}$ );
  - average speed ( $v_m$ );
  - standard deviation of speed ( $\sigma_v$ );
  - probability of having a vehicle of a given class in a given lane ( $P_{CL}$ ).
- as synthesised in Table 2.

Table 2: characterisation of the different vehicle classes

Vehicle Length (L)	L ≤ 5 m	5 < L ≤ 10 m				L > 10			
Length sub-classes	< 5	5-7.5	7.5-8.5	8.5-10	8.5-10	10-12		12-15	>15
Type of vehicle	Passenger car	Light Truck (2 axles)			Heavy Trucks (3 axles)		buses	Semitrailers and tractor-trailers	
Coding of vehicle type	<b>C1</b>	<b>C2</b>	<b>C31</b>	<b>C32</b>	<b>C41</b>	<b>C42</b>	<b>C7</b>	<b>C5</b>	<b>C6</b>
Mass (kg)	1500	6000	13000	13000	16000	16000	13000	26000	38000
centre of gravity height	0.53	1.5	1.5	1.5	1.5	1.5	1.4	1.9	1.9
vehicle width	1.5	2	2	2	2	2	2	2	2
Accident Rate - ( $P_{CA}$ ) (x 100. mil.of vehic/km)	4.52	0.292	0.074	0.149	0.092	0.213	0.02	0.1769	0.4331
average speed (km/h) - ( $v_m$ )	136	115	101	95	95	95	95	89	91
standard deviation of speed (km/h) - ( $\sigma_v$ )	21.4	24.4	22.5	17	17	15.5	15.5	12.3	9.9
Probability of travelling in a given lane (%) - ( $P_{CL}$ )									
Lane 1	9	58	58	58	58	84.4	84.4	84.4	84.4
Lane 2	49	34	34	34	34	15.3	15.3	15.3	15.3
Lane 3	21	4	4	4	4	0.15	0.15	0.15	0.15
Lane 4	21	4	4	4	4	0.15	0.15	0.15	0.15

The passenger cars (type C1) are the most critical for the definition of the maximum cross distance which can be reached by a vehicle running off the highway because of the high value of its speed at the highway edge while the heaviest vehicles (types C5 and C6) can be more critical for very close sections where the ballistic model is applied.

For the definition of the reference accident it was necessary to define a return time as indicated in the procedure described earlier but there is currently no standard on this specific issue. A sensitivity analysis was therefore conducted to compare the effect of setting different return times. In Figure 11 the results of this analysis referred to passenger cars are shown in terms of highway edge speed and runoff angle Vs the return time. In the same diagram the energy calculated with reference only to the side component of the speed is indicated. This value, calculated according to Eq. 20, is usually considered an important indicator of the severity of the runoff (as indicated also in EN-1317 standard on road restraint systems). This is not directly related to the cross distance that can be reached by the vehicle running off the road in the different situations, but can provide an indication of the relative effect of different return times.

$$E_T = \frac{1}{2} \cdot (v \cdot \sin \alpha)^2 \quad \text{Eq. 20}$$

This analysis shows that for return times between 5 and 200 years the edge speed increases from 167 to 188 km/h but, on the other hand, the runoff angle decreases considerably to maintain the equilibrium conditions detailed earlier in the procedure. The energy associated with the side component of the speed remains almost constant (127-129 kJ). It seems therefore that the effect of changing the return time is rather limited due to the fact that increasing the speed the maximum runoff angle tends to decrease.



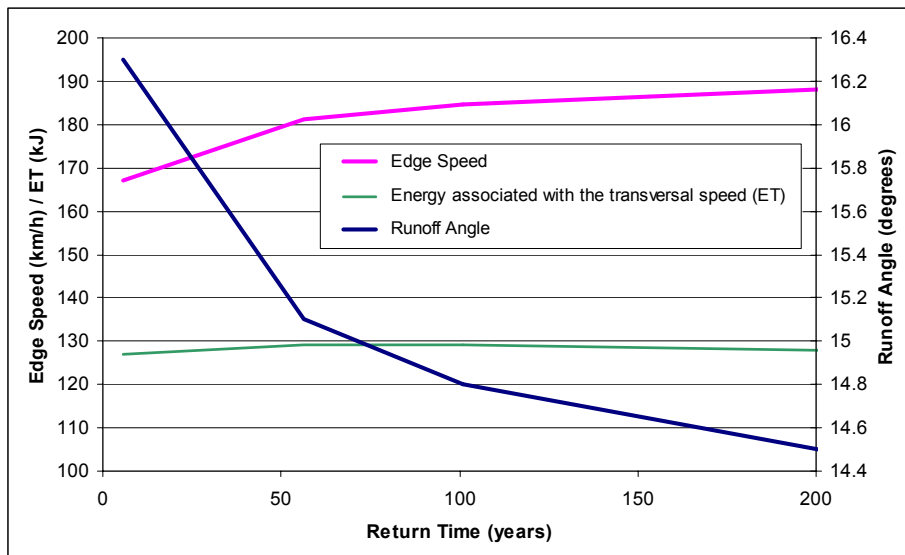

Figure 11: analysis of runoff speed and angle for different return times.

As far as there is not a direct relation between the maximum cross distance ( $L_P$ ) reached by a passenger vehicle and the energy associated with the transversal component of the speed a sensitivity analysis has also been performed calculating the  $L_P$  values with the different edge speed and runoff angle associated with the different return times. For this application the highway embankment has been considered with a height of 2m and a cross slope of 2/3. For the railway embankment different heights have been considering maintaining the 2/3 slope. The results of this analysis, shown in Figure 12, highlight that there is no considerable difference when ranging from 50 to 200 years while the 5 years return time is associated with a slightly lower value of  $L_P$  for all the different values of the railway embankment height. For the definition of design guidelines a return time of 100 years has been considered.

The results shown in Figure 12 highlight that, for a highway embankment of 2 m, the cross distance within which there is an interaction between the highway and the railway ranges from almost 55 m to almost 90 m when the railway embankment decreases in height from 5 to 0 m.

When changing the highway embankment height for a given return time (100 years, in the example of Figure 13) the effect is rather limited (in the order of 5 meters increasing the highway embankment height from 0 to 5 m).

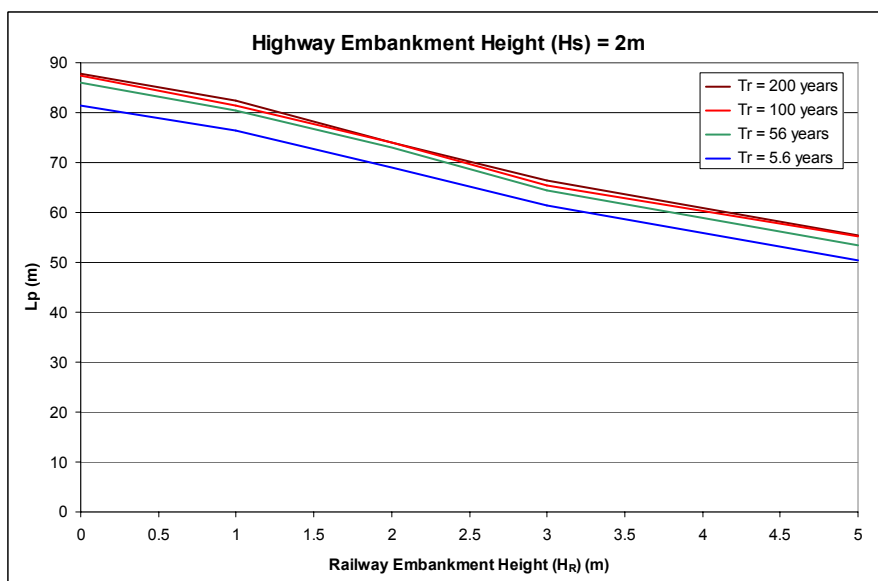

Figure 12: variation of the minimum required cross distance ( $L_P$ ) with the height of the railway embankment for different return times.

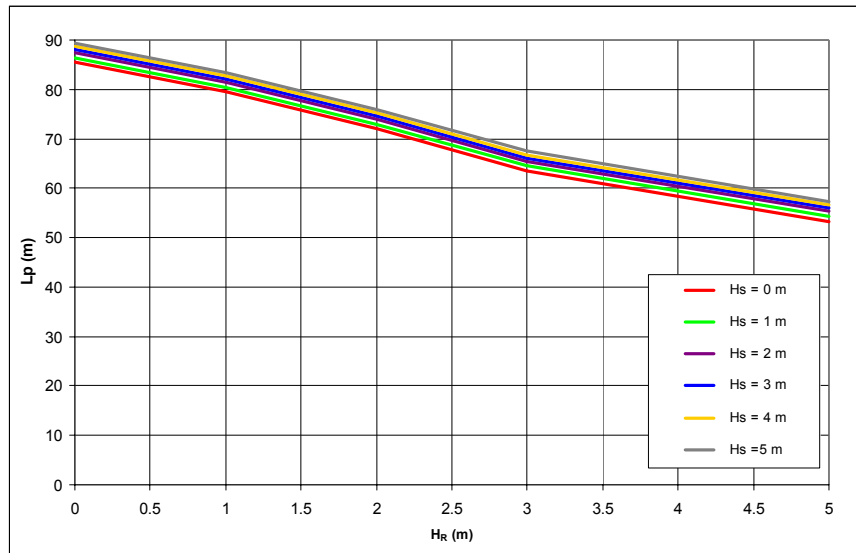

Figure 13: variation of the minimum required cross distance ( $L_P$ ) with the height of the railway embankment for different highway embankments heights with a return time of 100 years.

When the railway is closer to the highway than " $L_P$ " the vehicle running off the highway can climb over the railway embankment causing an invasion of the railway track. If the railway embankment is supported by a retaining wall this might offer the required level of protection to the railway track if:

- the height of the retaining wall is such that the main body of an errant heavy vehicle hits against it;
- the overall height of the railway embankment (excluding, in this case, the sub-ballast), is higher than the overall vehicle height in order to prevent the load from landing over the rail track ones the body has impacted against the retaining wall.

The minimum height of the retaining wall has been set to 1.50 m while the railway embankment has to be at least 4.00 m, being this the maximum height allowed by the Italian Road Code for an heavy vehicle.

The last situation in which the railway can be considered as "self protected" is the configuration where the railway is very close to the highway and the railway retaining wall has an height compatible with the minimum required to prevent from an invasion of the track by an errant vehicle. For this application the ballistic model has been applied considering a return time of 100 years and two different type of vehicles: a passenger car and a semi-trailer. As indicated earlier in describing the proposed model when the semi-trailer is considered a 2 m elevation is added to the trajectory of it's centre of gravity to prevent for an invasion of the load on the railway track. The results of this analysis are shown in Figure 14 where in the upper part the trajectory of the centre of gravity is described in terms of elevation ( $Z$ ) with reference to the highway pavement height while in the lower part the maximum difference in elevation between the railway retaining wall edge and the highway pavement ( $\Delta H$ ) is given as a function of the cross distance ( $W$ ) between the two retaining walls. It can be seen that the semi-trailer is more critical when the cross distance is lower than 9 m while the passenger car becomes critical for higher distances.

It can also be seen that considering an highway embankment height of 5-6 m the maximum distance reached by the vehicle during this phase is approximately 15-16 m.

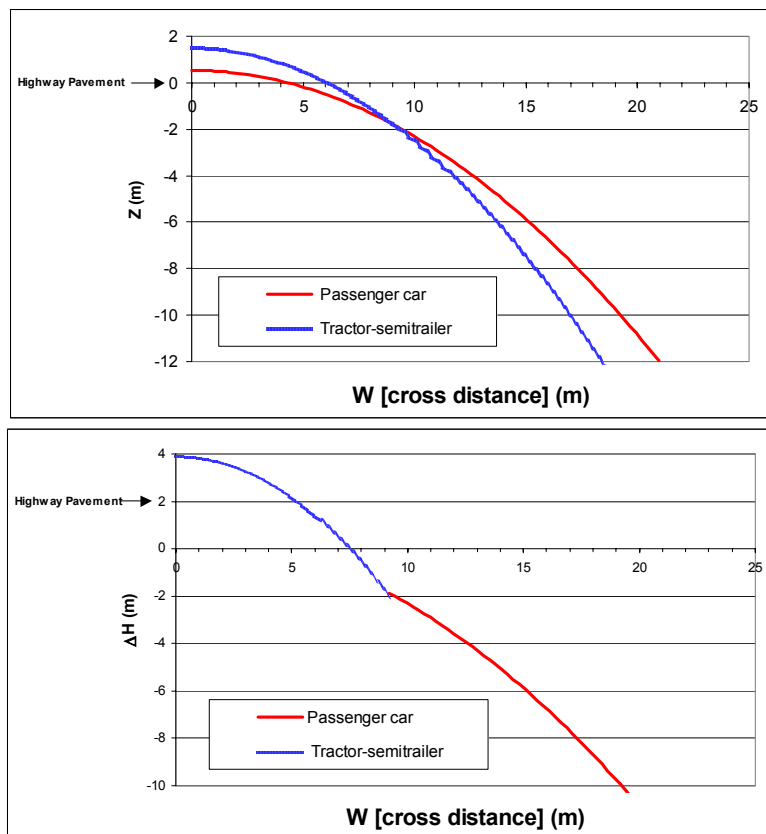

Figure 14: application of the ballistic model to different type of vehicles with return time of 100 years.

In all the situations that cannot be considered as “self-protected” a specific protection system has to be designed. The best option, if the space available in the interposed area is sufficient, is to built a protection embankment which can slow down the errant vehicle. The model proposed in this paper has been developed so to be able to simulate also the runoff over a section with a protection embankment and applied for the definition of specific design criteria, not detailed in this paper.

## CONCLUSIONS

This paper presents a model to evaluate the interaction between an highway and a railway track running almost parallel in a “multimodal corridor” with cross distances ranging between less than 10 to over 100 m.

The model simulate both the behaviour of the vehicle on the road, from when the driver looses it's travelling lane to when it reaches the roadway edge, defining also the maximum possible runoff angle for a given travelling speed and vehicle type.

The off-road behaviour has been modelled considering both the “ballistic” problem of the vehicle flying off the road section, in the area close to the roadway edge, and the problem of the vehicle running in contact with the surface, for larger cross distances.

For the application of the model it is necessary to identify a “reference accident” which is described by means of a vehicle type, a given runoff speed and angle. A procedure to define these factors with a probabilistic approach from the accident data, the traffic conditions and the monitored speed distribution has been described in the paper. The “return time” (which is the time within which a given event should occur only once) has to be set in order to define these input values.

An example of application of the model is shown for a 130 km of multimodal corridor where a sensitivity analysis has been also conducted to investigate the effect of changing the return time.

The results have shown that the errant vehicle can result in a rail track invasion for cross distances ranging from 50 to 80 m, depending on the railway embankment height. The highway embankment height has, on the other hand, a very limited effect on the distance reached by the errant vehicle.

## ACKNOWLEDGEMENTS

The authors wish to acknowledge the work done by Dr. Eng. Andrea Rindi and Dr.Eng. Mirko Rinchi of the Department of Energetics of the University of Florence who have implemented the off road model in the simulation environment.

## REFERENCES

- [1] EN1317-2 "Road Restraint Systems – Part 2: Performance classes, impact test acceptance criteria and test methods for safety barriers", April 1998
- [2] Italian Road Code, D.LGS. 30 April 1992, N. 285 and following modifications;
- [3] CNR (1995) *Criteri per la classificazione della rete delle strade esistenti ai sensi dell'art. 13, comma 4 e 5 del Nuovo Codice della Strada* D.P. CNR N. 13465
- [4] Ang Alfredo H-S., Tang Wilson H., (1975) *Probability concepts in engineering planning & design*, Vol.I- Basic Principles, Ed. John Wiley & sons – ISBN 0-471-03200-X
- [5] Mak K. K., Sicking, D. L., Ross H. E. Jr., (1986) *Real World Impact Conditions for Ran-off-the-Road Accidents*, Transportation Research Record 1065, Transportation Research Board, Washington, D. C., USA.
- [6] Lamm R., Psarianos B., Mailaender T, (1999) *Highway Design and Traffic Safety Engineering Handbook*, Ed. Mc Graw - Hill – ISBN 0-07-038295-6
- [7] Nordström O., Åström H. (2001) *Upgrading of VTI friction test vehicle BV12 for combined braking and steering tests under aquaplaning and winter conditions* 2<sup>ND</sup> International Colloquium on Vehicle Tyre Road Interaction - Friction potential and safety: prediction of handling behavior, Firenze – Italy
- [8] Galindo B. (2001) *Simulating potentially dangerous situations* 2<sup>ND</sup> International Colloquium on Vehicle Tyre Road Interaction - Friction potential and safety: prediction of handling behavior, Firenze – Italy
- [9] Bertin A., Poli M., Vitale A. (1997) *Fondamenti di Meccanica* Ed. Esculapio
- [10] D'Andrea Antonio (1994) *Traiettorie dei veicoli stradali in assenza di aderenza*, *Rivista Le strade*, n°1301 year XCVI
- [11] AASHTO (2001) *A policy on geometric design of highways and streets* 4<sup>th</sup> Edition, Ed. American Association of State Highway and Transportation Officials, ISBN 1-56051-161-3