



UNIVERSITÀ
DEGLI STUDI
FIRENZE

FLORE

Repository istituzionale dell'Università degli Studi di Firenze

Construction issues of insuring sight distances in tunnels.

Questa è la Versione finale referata (Post print/Accepted manuscript) della seguente pubblicazione:

Original Citation:

Construction issues of insuring sight distances in tunnels / L. Domenichini; F. La Torre Bellardoni; L. Rossi.
- ELETTRONICO. - (2004), pp. ---. (Intervento presentato al convegno 2nd International Congress SIV
2004 - New Technologies and modelling tools for roads tenutosi a Firenze, Italia nel 27-29 Ottobre 2004).

Availability:

This version is available at: 2158/238344 since:

Terms of use:

Open Access

La pubblicazione è resa disponibile sotto le norme e i termini della licenza di deposito, secondo quanto stabilito dalla Policy per l'accesso aperto dell'Università degli Studi di Firenze
(<https://www.sba.unifi.it/upload/policy-oa-2016-1.pdf>)

Publisher copyright claim:

(Article begins on next page)

Construction Issues of Insuring Sight Distances in Tunnels

Lorenzo Domenichini
Professor – University of Florence

Francesca La Torre
Associate Professor – University of Florence

Lorenzo Rossi
Research Assistant – University of Florence

SYNOPSIS

The Italian national standard on road geometric design (D.M. n. 6792 of 05.11.2001) requires, as a basic safety control tool in road design, to insurance that the available sight distances must always be equal or greater than the required stopping distances. This condition has to be guaranteed also and especially in tunnels, where the risk of accident is very high because of the severity and the consequences that a crash can generate.

On the other hand insuring sight distances in tunnels, for a given type of road, can lead to require road cross sections enlargements in curves that can be very consistent (up to 7.80 meters) and this strongly affect the tunnel feasibility and the excavation costs.

In this study the enlargements required in order to insure sight distances in tunnels for three lanes type A and type C roads, have been calculated for different curvature radii and different slopes. The effects of these enlargements on the related excavation tunnel sections and on excavation costs, have been investigated.

In reference to these analysis different construction issues have then been evaluated in order to develop some indicative guidelines, for the design of road geometry in tunnels, enabling to limit the problem of visibility and consequently to contain cross section enlargements and additional costs.

In particular the possible measures investigated to control required enlargements, deal with the optimization of plano-altimetric design, enforcing the maximum legal speed limit, imposing speed limits, controlling the risk increase, and finally increasing friction coefficients. Moreover the opportunity of using handling simulation tools to evaluate the actual breaking distances has been envisaged.

Construction Issues of Insuring Sight Distances in Tunnels

INTRODUCTION

The Italian national standard on road geometric design [1] has been issued in 2001 with the main objective of increasing road safety. One of the safety controls required by the standard refers to the comparison of the locally available sight distances (ASD) to the required stopping distance (RSD). This implies that in the bends the side obstacles have to be placed far enough from the carriageway in order not to reduce the ASD below the RSD. This control is considered a very important safety measure and it has to be verified also and especially in tunnels where visibility conditions are more critic than in other road elements and the consequences of an accident might be particularly severe. As a matter of fact in the section of the standard specifically devoted to tunnels it is highlighted that: “the right and left shoulders width indicated in the present paragraph, are defined as minimum values and have to be increased if lateral clearance is needed in order to insurance visibility..”

The will of the legislator is clearly to stress the importance of ensuring safe driving conditions. This likely leads to enlarged tunnel sections to insurance sight distances, and consequently to increased construction times and costs.

This study has been conducted to investigate the implications of insuring sight distances compatible with the required stopping distances in terms of construction costs of tunnels. Moreover some possible mitigation interventions have been considered in order to reduce construction costs still achieving acceptable safety conditions.

EVALUATION OF CROSS SECTION ENLARGEMENTS REQUIRED IN BENDS FOR DIFFERENT ROAD TYPES

The Italian standard on road geometric design requires to ensure that the locally available sight distances (ASD) are always equal or greater than the required stopping distances (RSD). The RSD depends on many factors such as pavements and tires characteristics, road geometry, vehicle dynamic conditions and user behavior.

According to the Italian standard the stopping distance can be calculated as a function of design speed, road altimetric layout and pavement skid resistance by means of Eq. 1:

$$\text{Eq. 1} \quad RSD = D_1 + D_2 = \frac{V_0}{3.6} \times \tau - \frac{1}{3.6^2} \int_{V_0}^{V_1} \frac{V}{g \times \left[f_t(V) \pm \frac{i}{100} \right] + \frac{Ra(V)}{m} + r_0(V)} dV$$

where the parameters and the relative values (given in parenthesis) assumed in the standard are:

D_1 [m]	= distance covered in the reaction time τ
D_2 [m]	= distance required to reduce the speed from V_0 to V_1
V_0 [km/h]	= vehicle speed before the breaking maneuvers (supposed to be equal to the design speed)
V_1 [km/h]	= final vehicle speed ($V_1 = 0$ for stopping maneuver)
i [%]	= road longitudinal slope (positive if uphill)
τ [s]	= total reaction time (τ [s]=2.8-0.01V[km/h])
g [m/s ²]	= acceleration of gravity
Ra [N]	= aerodynamic drag which can be evaluated, according to the standard, by means of Eq. 2:

$$\text{Eq. 2} \quad Ra = \frac{1}{2 \times 3,6^2} \rho C_x S V^2$$

where:

- C_x = aerodynamic coefficient (0.35)
 S [m^2] = vehicle cross section area ($2.1m^2$)
 ρ [kg/m^3] = volume unit mass of air in standard conditions ($1.15kg/m^3$)
 m [kg] = vehicle mass (1250kg)
 r_0 [N/kg] = rolling resistance (can be ignored in the calculation)
 f_l = longitudinal friction coefficient that can be assumed as available for breaking maneuvers.
 The standard provides the f_l values for wet surfaces (0.5 mm of water depth) which have to be considered in the calculations, as shown in Table 1.

Table 1: Values of f_l (longitudinal friction) coefficients defined in the Italian standard for the calculation of stopping maneuver

SPEED (km/h)	25	40	60	80	100	120	140
fl - Highways	0.61	0.56	0.50	0.44	0.40	0.36	0.34
fl - Other roads	0,45	0.43	0.35	0.30	0.25	0.21	-

The ASD varies along the road path and depends on the road cross section composition, the distance of lateral obstacles and the road geometric layout (planimetric and altimetric characteristics).

In this study two different types of roads (referred to Italian Road Code [2]) have been considered:

- type C roads (single carriageway Secondary roads) that have a minimum cross section of 10.50m ⁽¹⁾
- type A roads (dual carriageway Highways) with 3 lanes that have a minimum cross sections of 14.95m ⁽²⁾

For the ASD calculation and the definition of the required enlargements of the type C sections, only the right-hand bend has been considered as the vehicles travelling in the same curve in the opposite direction have a considerable higher ASD.

When type A sections are analysed the following consideration should be made: the right-hand bends affect the position of the right margin of the carriageway and the internal lane radius is lower than in left-hand bends; in left-hand bends the ASD is affected by the position of the obstacle in the left margin of the carriageway (typically the median safety barrier).

For this reason two different configurations have been considered for type A roads for vehicles travelling in the two different directions. The different configuration considered in this paper, are therefore:

- single carriageways right-hand bends (type C roads)
- dual carriageway left-hand bends (type A roads)
- dual carriageway right-hand bends (type A roads)

The ASD in bends with a given radius has been estimated with an approximated solution as shown in Figure 1, Figure 2 and Figure 3 where the following notations have been used:

- P is the position of the driver eyes
- P' is the position of the object that has to be seen by the driver
- r is the curve radius
- ρ is the radius of the internal lane
- m is half width of the road lane
- ls is the left shoulder
- rs is the right shoulder
- Δ is the shoulder enlargement required to provide an ASD equal to the RSD
- PP' is the line of visibility tangent to the obstacle that obstruct the driver view
- D is the travelled distance, measured along the actual vehicle trajectory, that is set equal to the RSD

The road design axis was assumed coincident with the left edge of the carriageway for type A roads while it was assumed in the center of the carriageway for type C roads.

¹ The sections base lanes are 3.75m wide, while the right and left shoulders size are 1.50m

² The sections base lanes are 3.75m wide, the right shoulder (emergency lane) is 3.00m while the left shoulder 0.70m.

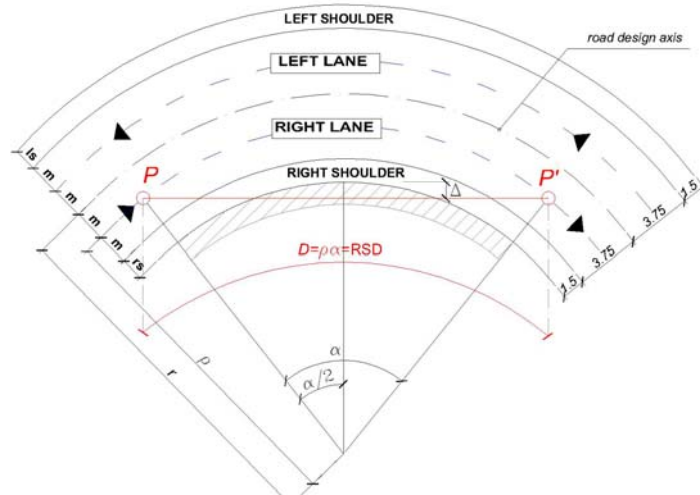

Figure 1: Cross section enlargement (Δ) required in Single Carriageway right-hand bends

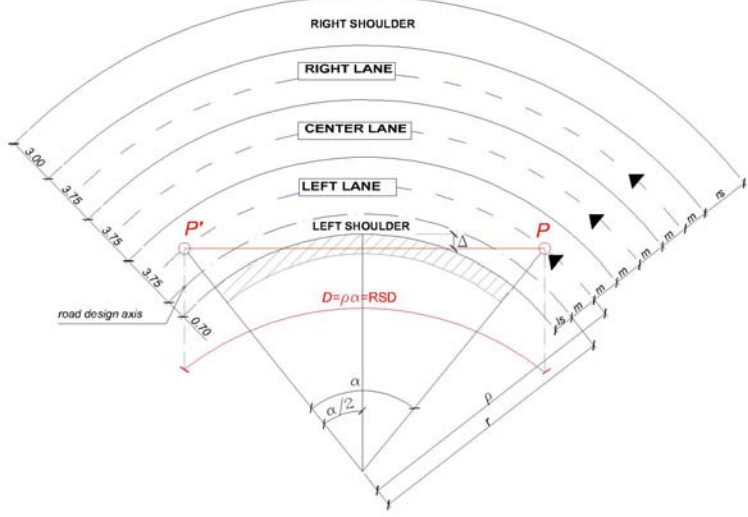

Figure 2: Cross section enlargement (Δ) required in Two Carriageways Roads left-hand bends

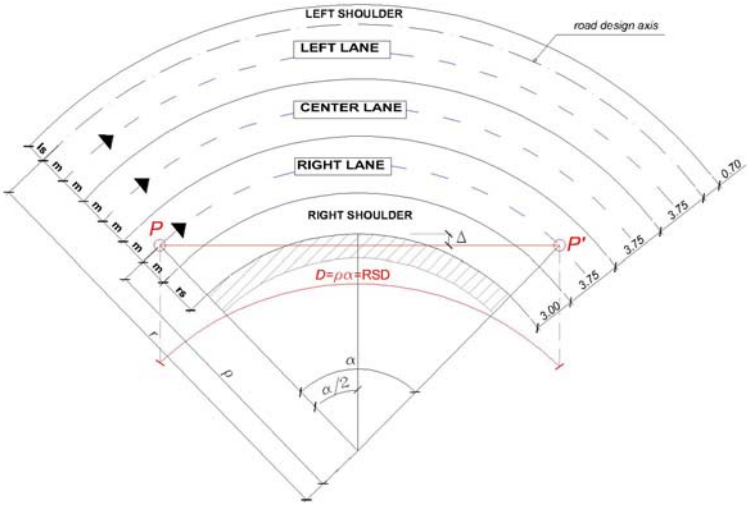

Figure 3: Cross section enlargement (Δ) required in Two Carriageways Roads right-hand bends

This schematization is valid in the simplified situation in which:

- the road bends with constant radius has a length greater than RSD
- the longitudinal grade is constant
- the visibility obstacle is at the same distance from the travelling path for heights below the drivers eyes (fixed at 1.10m from the pavement)
- the cross fall is constant

Dealing with the three different schemes in Figure 1, Figure 2 and Figure 3 it is possible to calculate the enlargement Δ require to allow an ASD equal to the RSD, using equation Eq. 3.

$$\text{Eq. 3} \quad \Delta = \rho \left(1 - \cos \frac{D}{2\rho} \right) - m - s$$

where:

$s=rs=1.50m$ and $\rho = r - m$ for right-hand bends in type C roads (Figure 1)

$s=ls=0.70m$ and $\rho = r + m$ for left-hand bends in type A roads (Figure 2)

$s=rs=3.00m$ and $\rho = r - 5 \cdot m$ for right-hand bends in type A roads (Figure 3)

For each type of road the RSD values have been calculated for several different curves radii with the minimum value Rmin defined according to the Italian standard for the given type of road and for three different longitudinal slopes:

- horizontal slope (i=0%)
- the maximum ascending slope defined in the standard for the given road type in tunnels (i=+4% for type A roads and i=+7% for type C roads).
- the maximum descending slope defined in the standard for the given road type in tunnels (i=-4% for type A roads and i=-7% for type C roads)

The design speed for each curve radius required to calculate the RSD, has been defined according to the Italian standard on road geometric design [1].

The enlargements required for the different curves have been calculated using Eq. 3 with reference to the minimum cross section for each type of road and have been reported in the set of diagrams enlargement Vs curve radii shown in Figure 4, Figure 5 and Figure 6 respectively for right-hand bends in type C roads, left-hand bends in type A roads and right-hand bends in type A roads.

In each diagram the required enlargements calculated for horizontal slopes are represented in blue, the ones related to the maximum ascending slope in green and the ones for maximum descendent slope in magenta. Using this representation the actual required enlargement for a bend with a given radius and a given longitudinal slope (within the minimum and the maximum allowed by the Italian standard), is contained in the range of values defined by the green and the magenta curves.

In all the diagrams the different curves are characterized by similar trends: a first part with enlargements increasing rapidly until a peak value is reached (corresponding to R=964m and R=437m respectively for type A and type C roads), and a second part with decreasing enlargement values from the peak to radii where the standard section allows an ASD compatible with the RSD.

For type C roads (Figure 4) the maximum enlargement corresponding to R=437m ranges from 2.80m (for uphill grades) to 7.80m (in downhill grades). When a flat profile is considered, the minimum required enlargement related to the most critic curve results to be equal to 4.60m.

For type A roads with 3 lanes, considering left-hand bends (Figure 5), the maximum enlargement related to R=964m, ranges from 3.50m to 5.40m with a required enlargement of 4.30m for horizontal segments. The maximum required enlargement drops to 3.20m for right-hand bends (Figure 6).

It should be noticed that for similar radii values the enlargements required for type A roads are considerably smaller than those required by type C roads since the friction values assumed by the Italian design standard (Table 1) are higher for the first type of roads. Given the fact that in bends with the same radius the design speed is the same (independently of the road type) the RSD for type C roads are higher than for type A ones and this leads to require higher enlargement to insure the required visibility.

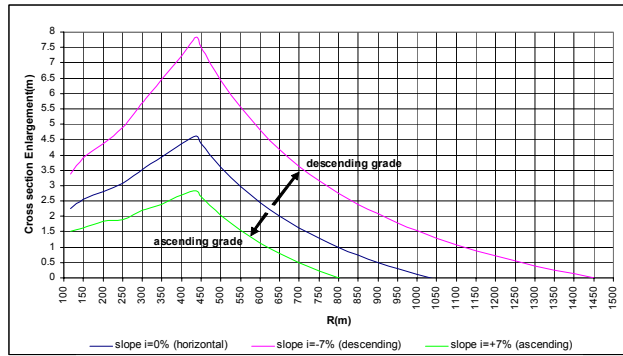

Figure 4: Minimum required enlargements Vs Radii for curves in Type C Roads

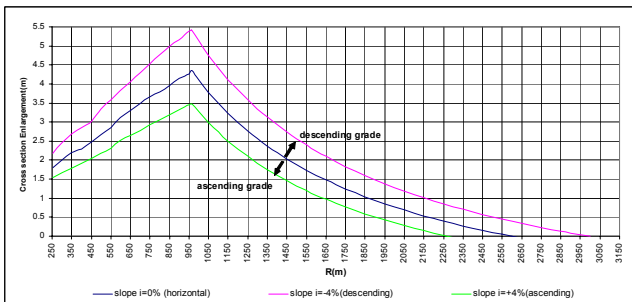

Figure 5: Minimum required enlargements Vs Radii for left-handed curves in Type A Roads (3 lanes)

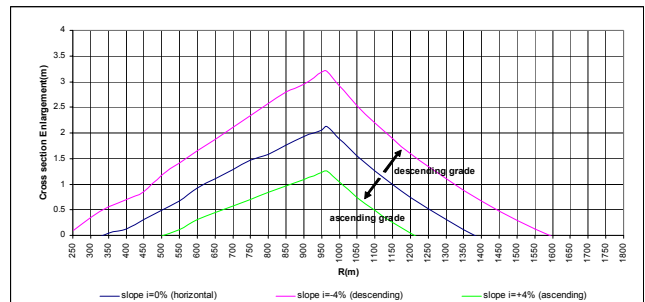

Figure 6: Minimum required enlargements Vs Radii for right-handed curves in Type A Roads (3 lanes)

COST ANALYSIS RELATED TO INCREASING EXCAVATION VOLUMES

Modern excavations techniques used to realize tunnels can be mainly grouped in two categories:

- the mechanical techniques based on full-face shielded TBM
- the conventional methods based on drill and blast excavations.

The normally available excavation shielded TBM are able at the present to realize bored tunnels with the maximum diameter contained within 15-16 meters, which leads to boring surfaces of about 175-200m². For wider boring surfaces traditional drill and blast techniques have to be adopted or custom made equipments have to be used as those shown in Figure 7.



Figure 7: Wide surface boring machines used in Japan

Tunnel construction costs usually consists of:

- excavation costs
- external lining costs
- internal lining costs
- different costs

In this study the cost analysis related to increasing tunnel areas, has been developed in terms of excavation costs since it seems reasonable to suppose that this is the economic parameter in tunnel construction that results more affected by increasing excavation volumes. Moreover other cost variables, such as lining and “different cost” are less dependent from tunnel section enlargements.

To define the unit costs of excavation in different conditions, a study has been conducted by W. Stainer [3] based on the comparison between drill and blast and TBM techniques for different soil types for a large diameter tunnel with a 6m radius and an excavation area surface of 115m². The results of this study reported in Figure 8, highlighted that for soft rocks the cost of excavation is usually lower for TBM than for drilling and blasting³. Moreover the cost for the external lining is generally larger for TBM (initial support) but the final liner cost is least for mechanized methods since no cost for filling over-break with concrete has to be included. For harder rocks the cost of TBM excavation may increase, substantially due to the lower penetration of the disks and to the higher energy required.

In particular from Figure 8 it can be assumed as a general indication that the excavation costs per tunnel linear meter can be fixed in 4000euro/m for mechanized methods and 5000euro/m for conventional methods considering rock classes with average geotechnical characteristics.

Considering the excavation area surface of 115m² considered in Steiners’ study, the excavation cost per m³ can be assumed of approximately 35euro/m³ when TBM methods are considered and approximately 44 euro/m³ when conventional methods are considered.

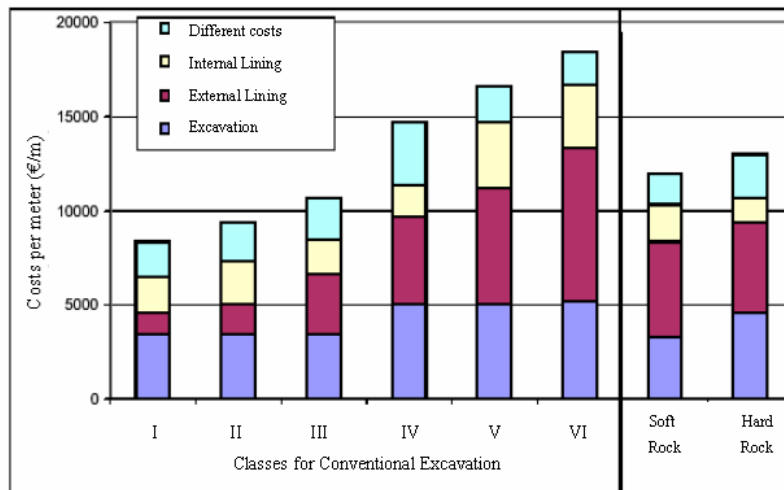

Figure 8: Costs per linear meter of tunnel and class

The cross section enlargements needed to provide the required sight distances lead to an increase of tunnel excavation area which has to be considered at the design stage. To better investigate this issue, for each given type of road, a “reference tunnel” has been defined considering that, according to the Italian design standard, a minimum height of 4.80m has to be guaranteed over the shoulders and a minimum height of 5.00m over the carriageway as shown in Figure 9 and Figure 10.

³ The minor costs of excavation using shielded TBM if compared to conventional ones is mainly due to the higher productivity of these mechanical techniques. The average speed of mechanized method is in fact of about 10-15m/day in soils with reduced self-sustained properties and of 15-20 m/day in rocks, while for conventional methods it is reduced respectively to 1-3m/day and 6-8m/day.

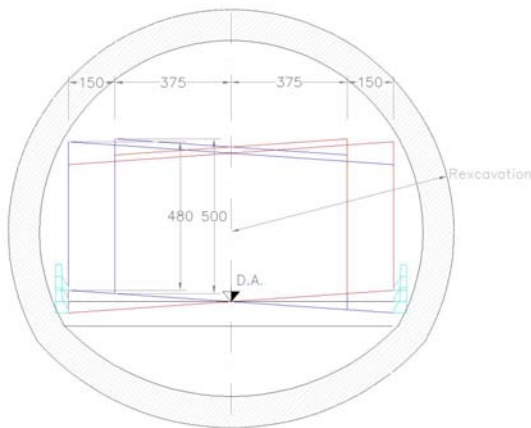

Figure 9. Reference tunnel for type C roads

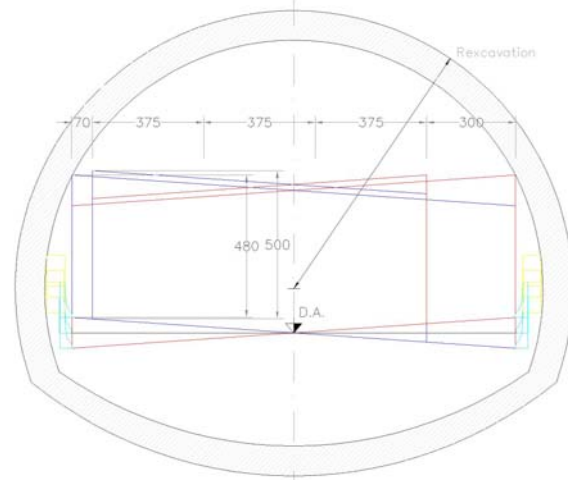

Figure 10: Reference tunnel for type A roads (3 lanes)

The type C reference tunnel, referred to the road cross section of 10.50m, resulted to be characterized by an internal radius of 6m. As discussed earlier this section can be realized both with conventional methods or with standard TBM techniques: in the first case it has been considered a lining thickness of 1m and an invert arc radius of 7.5m for a total excavation area surface of about 145m². In second case, the lining thickness has been reduced to 0.80m but considering a circular section for a total excavation area which results almost the same as for the conventional methods (145m²).

When the required enlargements for this type of roads are contained within 1.50m the excavation diameter results lower than 15-16m and consequently shielded TBM can be used, while for greater enlargements the excavation technique is necessary a traditional one.

If the 3 lanes type A roads are considered only conventional methods can be used as the reference tunnel area is already characterized by an excavation diameter wider than the maximum indicated above (15-16m). The reference section has therefore been characterized by means of an internal radius of 8.40m, a lining thickness of 1m, and an invert arc of about 14m, for a total excavation area surface of 236m².

The total surface of tunnel excavation area for increasing required enlargement values have been calculated and then compared with the surfaces of the standard excavation area, with the results shown in Figure 11 and Figure 12. It has to be noted that in type C roads the excavation area considered was referred to the TBM methods for enlargements lower than 1.50m and to conventional methods for greater enlargements.

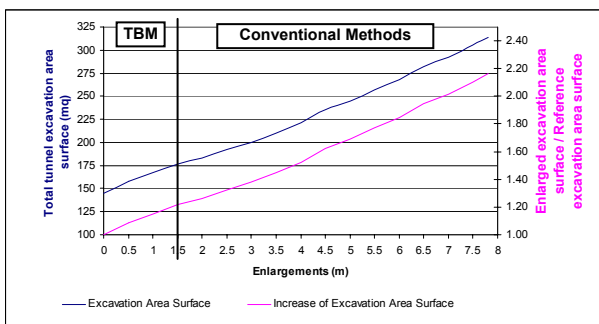

Figure 11: Evaluation of Excavation Area Surface in type C roads Tunnels for increasing required enlargements

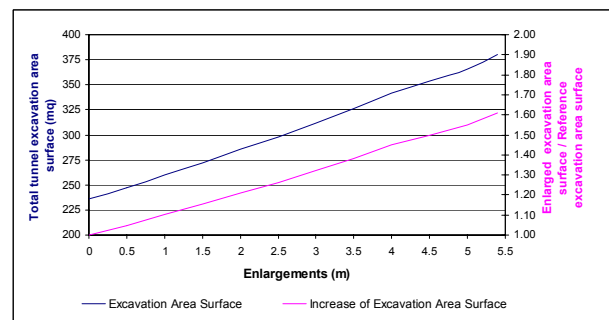

Figure 12: Evaluation of Excavation Area Surface in type A road Tunnels for increasing required enlargements

Figure 11 shows that the maximum tunnel excavation area for type C roads is of about 315 m² for the greatest enlargement required of 7.80m (referred to a bend radius of 437m, as shown in Figure 4) that is associated to an increase of the excavation surface of almost 2.2 times if compared to the reference one.

If type A roads are considered (Figure 12) the biggest tunnel section related to the maximum enlargement of 5.40m (for a left-hand bend with radius of 964m, as shown in Figure 5) is characterized by an excavation surface of 380 m² that is about 1.6 times the reference one.

Under the approximated assumption, that should be further investigated, that the excavation costs per unit volume is constant with increasing tunnel sections, using the excavation costs per cubic meter defined according to Steiner's study, the tunnel excavation cost realized in the same site but with increasing excavation areas (due to the enlargements) have been estimated.

The results are shown in Figure 13 and in Figure 14 where the excavation costs (Y left axis) and the increase of excavation costs (Y right axis) have been plotted versus road section enlargement values respectively for type C and type A roads.

For type C roads the excavation costs have been evaluated assuming, in accordance with the considerations discussed earlier on the excavation techniques, that section with enlargements up to 1.50m will be realized with a TBM while larger sections require the use of conventional drill and blast methods. Therefore the cost increase is due not only to the increase in the excavation area but also to the change of excavation technique. In Figure 13 this results in a sudden increase in the excavation costs for the required enlargements between 1.00 and 1.50m.

As discussed earlier the three lanes type A roads have been considered as always realized with conventional methods since the base section is already too large for using TBM. In this case the increase of excavation costs is due only to the increase of excavation volume so its trend, described by the magenta line in Figure 14 is actually the same than the one of Figure 12.

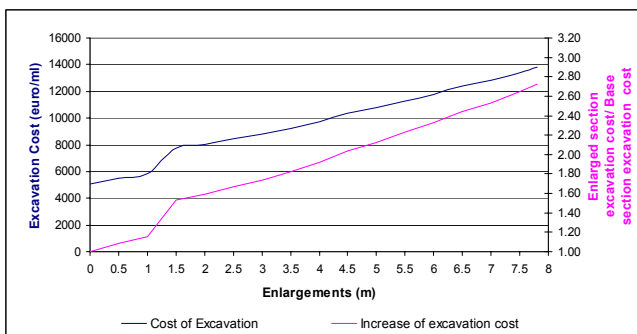

Figure 13: Evaluation of Excavation Cost in type C roads Tunnels for increasing cross section enlargements

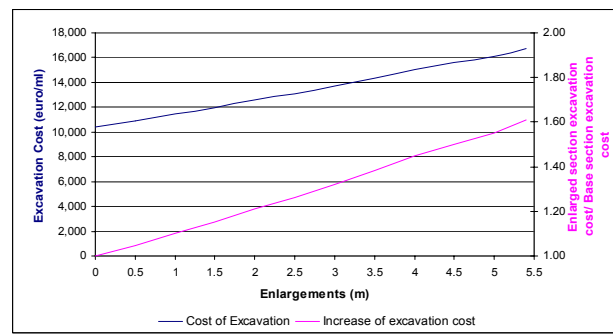

Figure 14: Evaluation of Excavation Cost for left and right hand curves, in 3 lanes type A roads Tunnels for increasing cross section enlargements

According to these approximated cost figures the following considerations can be derived:

- the maximum enlargement required on type C roads, referred to a downhill bend with a 437m radius of curvature, implies an increase in costs of approximately 270% (from 5000 to 14000 €/m)
- the maximum enlargement required on left-hand bends in type A roads, referred to a 964m radius of curvature, on the maximum downgrade slope, implies an increase in cost of approximately 160% (from 10400 to 16700 €/m)
- for right-hand bends in type A roads the maximum costs increase is limited to 135% (from 10400 to 14000 €/m) due to the fact that the maximum enlargement (for the same 964m radius curve) is reduced to 3.20m.

DESIGN OPTIMIZATION FOR THE LIMITATION OF CROSS SECTION ENLARGEMENTS

As shown in Figure 4, Figure 5 and Figure 6 some bend's radii result to be more unfavorable in terms of insuring sight distances for stopping maneuvers. The maximum enlargement required for type A and C roads is associated with radii of 964m and 437m respectively.

To control the consequent increase in construction costs the first option for limiting the required enlargements consist of course in avoiding the worst plano-altimetric combinations.

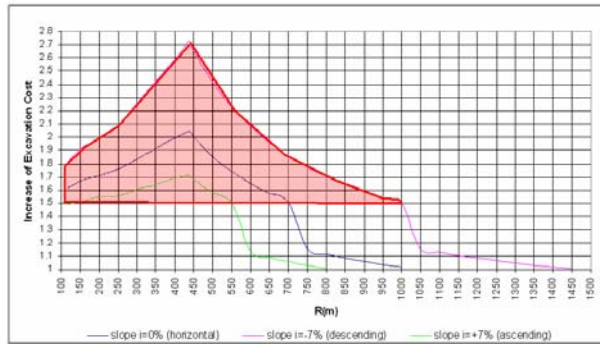

Figure 15: Plano-altimetric combinations that have to be avoided in type C roads tunnels in order to limit the increase of excavation costs within 50%

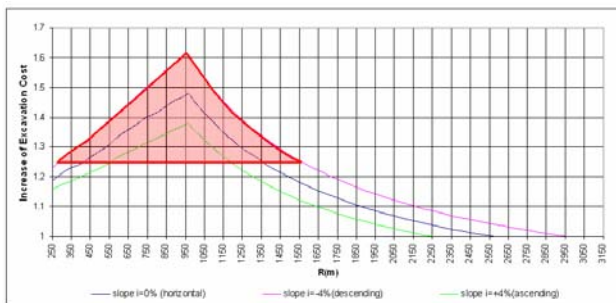

Figure 16: Plano-altimetric combinations that have to be avoided in left-hand bends in type A roads tunnels in order to limit the increase of excavation costs within 25%

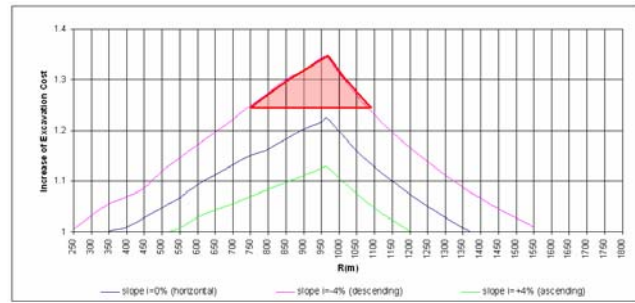

Figure 17: Plano-altimetric combinations that have to be avoided in right-hand bends in type A roads tunnels in order to limit the increase of excavation costs within 25%

As an example allowing a maximum cost increase of 50% for type C roads and of 25% for type A roads the plano-altimetric combinations to be avoided are shown in Figure 15, Figure 16 and Figure 17 and summarized in Table 2.

Table 2: Plano-Altimetric combinations to avoid in order to limit the increase of Tunnel excavation costs within 50% for type C roads and 25% for type A roads

Road Type	Curve	Radii values (in m) that have to be avoided in tunnels in order to limit excavation costs increase (50% type C roads and 25% type A roads)		
		Uphill maximum gradient	Horizontal slope	Downhill maximum gradient
Type C	Left OR Right-hand	0–550	0–700m	0–1000
Type A	Left-hand	550–1200	400–1350	300–1550
Type A	Right-hand	No limitations	No limitations	750–1100

EVALUATION OF POSSIBLE “MITIGATION” MEASURES FOR SECTIONS WITH INSUFFICIENT SIGHT DISTANCES

Should the enlargements required in tunnels to insurance the required sight distances be considered not feasible, mitigation intervention might be considered in order to control the risk of having a vehicle running with an ASD lower than the RSD. In this section different possible types of interventions have been evaluated.

ENFORCING SPEED LIMITS

The evaluation of the required enlargements in tunnels has highlighted that the most relevant problems occur for radii close to specific values (964m for type A and 437m for type C roads) which are the minimum curvatures allowed by the Italian standard for the maximum design speed (140km/h on type A and 100km/h on type C roads). It should be noted anyhow, that the Italian design standard has defined the maximum design speed as 10km/h higher than the maximum legal speed on these types of roads to account for the fact that a considerable amount of drivers travel above the speed limits.

If the speed is enforced in the tunnels by means of cameras, laser or radar devices, it can be assumed that the speed distribution will be considerably reduced with a very limited number of drivers travelling faster than the legal speed limit [13]. In this condition the RSD could be considered with reference to the speed limit instead than to the maximum design speed. Under this assumption the increase of the excavation costs for the different curvature radii become the ones shown in Figure 18, Figure 19 and Figure 20. In the same figures the plano-altimetric combination which should be avoided to limit the cost increase to 50% for type C roads and 25% for type A roads have been shaded.

The maximum required enlargement drops to 6.10m for type C roads, to 4.80m for left-hand bends of type A roads and to 2.60m for right-hand bends.

The critical radii become 339m for type C roads and 807m for type A roads.

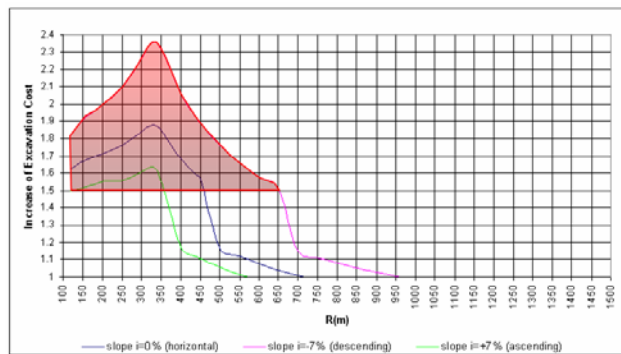

Figure 18: Influence of plano-altimetric layout on excavation costs increase for type C roads tunnels considering speed limits enforced

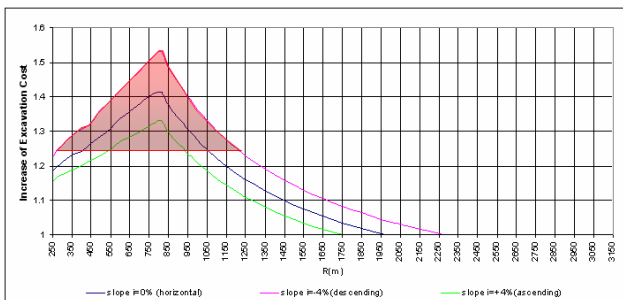

Figure 19: Influence of plano-altimetric layout on excavation costs increase for left-hand bends in type A roads tunnels considering speed limits enforced

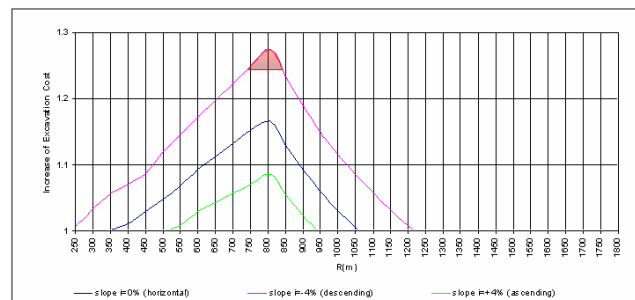

Figure 20: Influence of plano-altimetric layout on excavation costs increase for right-hand bends in type A roads tunnels considering speed limits enforced

According to these diagrams when speed limits are enforced the design optimization described earlier lead to a considerably reduced range of radii to be avoided, particularly with respect to type A roads. For right bends, as an example, only very steep downhill grades with radii between 750 and 850m should be avoided. In the same situation it is also interesting to note that for radii above 1250m no enlargement is required, independetly of the longitudinal grade.

IMPOSING A SPEED LIMIT

The most frequent “mitigation” measure is the imposition of a speed limit in tunnels. In defining the proper speed to be posted it should be kept in mind that, as said earlier, in the design standard the maximum

design speed is 10km/h higher than the maximum speed limit. This means that for a given tunnel section with an ASD lower than the RSD the maximum speed limit (V_s) should be defined as:

$$\text{Eq. 4} \quad V_s = V(\text{ASD}) - 10\text{km/h}$$

where $V(\text{ASD})$ is the speed for which the RSD would result equal to the ASD.

The actual speed limit to be posted in tunnels results from a compromise between the limitation in the cost increase and the need for allowing the drivers to travel at an acceptable speed.

Considering that the speed limit are usually set rounded to 10km/h the minimum required enlargement for any given posted speed limit can be defined by means of diagrams such as the ones shown with the red lines in Figure 21, Figure 22 and Figure 23 referred to the most critical condition for type C roads and for type A left-hand and right-hand bends.

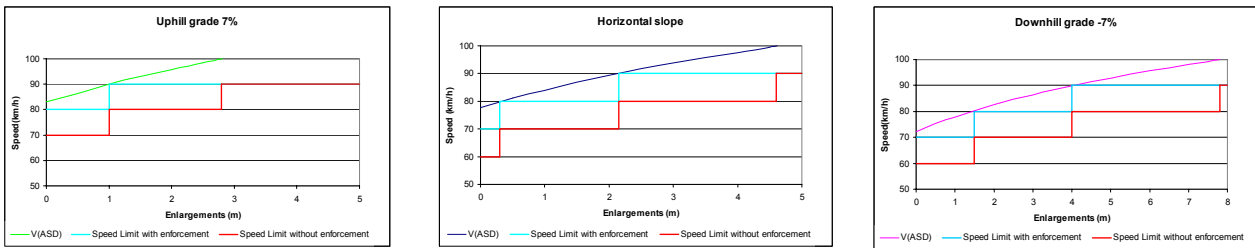

Figure 21: Required speed limit as a function of the enlargement actually realized for type C road most critical curve (R=437m)

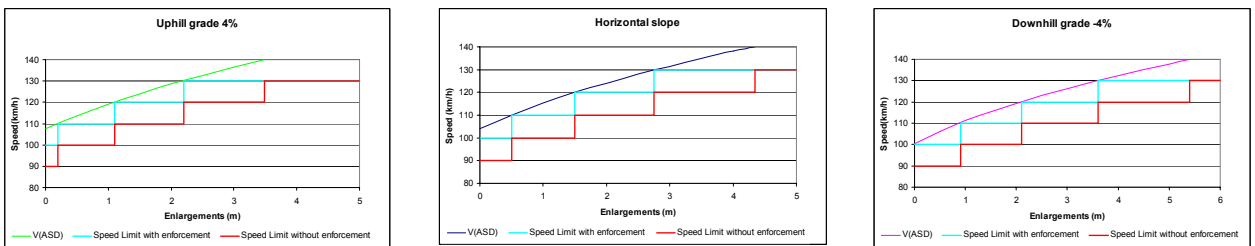

Figure 22: Required speed limit as a function of the enlargement actually realized for type A road most critical left-hand bend (R=964m)

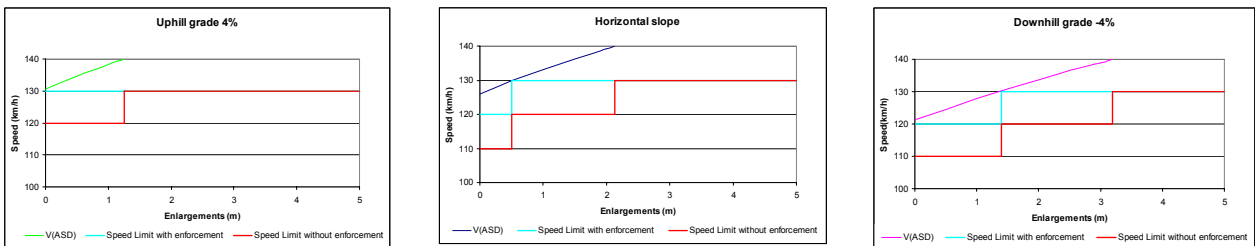

Figure 23: Required speed limit as a function of the enlargement actually realized for type A road most critical right-hand bend (R=964m)

The combination of actually realized enlargements and speed limits to be posted in type C right-hand bends with radius of 437m (which corresponds to a standard design speed of 100km/h and a legal speed limit of 90km/h), and in type A left and right-hand bends with radius of 964m (which corresponds to a standard design speed of 140km/h and a legal speed limit of 130km/h) are shown in Figure 21, Figure 22 and Figure 23 respectively, and summarized in Table 3.

Table 3: Combination of speed limits to be posted and actually realized enlargements that can be defined in type C right-hand bends with radius of 437m and in type A left and right-hand bends with radius of 964m

Type of road	Manoeuvre	Grade	Combination of speed limit to be posted and actually realized enlargements	
			Speed limit	Actually realized enlargement
C	Right-hand bends with radius of 437m	Maximum downhill grade (-7%)	60 km/h	<1.50m
			70 km/h	1.50-4.00m
			80 km/h	4.00-7.80m
		Horizontal slope	60 km/h	<0.30m
			70 km/h	0.30-2.20m
			80 km/h	2.20-4.60m
Maximum uphill grade (+7%)	70 km/h	< 1.00m		
	80 km/h	1.00-2.80m		
	90 km/h	< 0.90m		
A (3 lanes)	Left-hand bends with radius of 964m	Maximum downhill grade (-4%)	90 km/h	< 0.90m
			100 km/h	0.90-2.10m
			110 km/h	2.10-3.60m
		Horizontal slope	120 km/h	3.60-5.40m
			90 km/h	<0.50m
			100 km/h	0.50-1.50m
		Maximum uphill grade (+4%)	110 km/h	1.50-2.75m
			120 km/h	2.75-4.30m
			90 km/h	<0.20m
	Right-hand bends with radius of 964m	Maximum downhill grade (-4%)	100 km/h	0.20-1.10m
			110 km/h	1.10-2.20m
		Horizontal slope	120 km/h	2.20-4.30m
			110 km/h	<1.40m
		Maximum uphill grade (+4%)	120 km/h	1.40-3.20m
			110 km/h	<0.50m
120 km/h	0.50-2.10m			

If the imposition of a reduced speed limit is coupled with a speed enforcement measure it can be assumed, as discussed earlier, that the difference between the travelling speed and the posted speed drops down and the maximum speed limit can therefore be defined as:

$$\text{Eq. 5} \quad V_s = V(ASD)$$

The speed limit to be posted in this case, for the same curves shown before, raises of 10km/h in respect to the previous ones as shown in the same Figure 21, Figure 22, and Figure 23 with the cyan line.

CONTROLLING RISK INCREASE

If the specific context does not enable to avoid the most critical plano-altimetric combinations the required speed limit can be considerably lower than the legal limit leading to reduction in the quality of the service offered to the users which might accelerate after the speed limit zone is finished resulting in an unsafe driving. For this reason a higher speed limit might be adopted assuming to accept a given level of risk associated with the lack of visibility. The procedure for defining such a risk is defined in [11] and enables to define the speed limit to be posted in the case of speed enforcements, as:

$$\text{Eq. 6} \quad V_s = V(ASD) - \Delta V$$

The term ΔV identifies the range of speeds within which a driver, traveling below the posted speed limit, will still have a lack of sight distances.

The application of this approach depends on:

- the local speed distribution
- the maximum allowed risk

Figure 24 shows an example referred to a 964m horizontal slope left-hand bend on a type A road where the speed distribution has been assumed equivalent to the one in straight monitored in an existing three lanes section.

In this example the allowable risk has been set as 5% of the risk that can be associated to the section, if the full enlargement is realized (which means ASD=RSD), due to the fact that a given percentage of drivers travel over the section at a speed higher than the speed limit.

In Figure 24 the speed limits without considering an increase of risk are represented by red line (the same than the one in Figure 22) and are always located below the V_s line. The speed limits with a 5% increase of risk are instead represented by the green line and are characterized by some areas located above the V_s line representing the accepted risky situations.

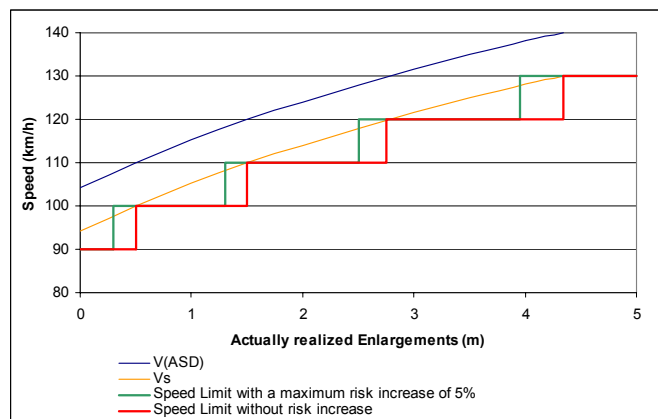

Figure 24: Example of speed limit with and without risk increase V_s actually realized enlargements (on a type A left-hand bend with radius of 964m)

INCREASING FRICTION COEFFICIENTS

The stopping distances required by Italian standard and calculated by means of Eq. 1 using the friction values showed in Table 1, are referred to wet surfaces (with a water depth of 0.50mm). A possible solution to visibility problems in tunnels could be found in the pavement surfaces which could be assumed dry and consequently the friction values could be considered higher. This would lead to shorter RSD values and therefore to less critic conditions for insuring sight distances.

To investigate friction on dry surfaces experimental data resulting from VERT Research Project, funded by the UE between 1999 and 2001 (Brite Euram Project BR PR-CT97-0461), have been considered. Analyzing the longitudinal friction coefficients on dry surfaces summarized in Table 4, it is possible to obtain an average value of approximately 0.7 that can be considered constant with speed and almost independent from the surface texture characteristics.

Table 4: VERT longitudinal friction measures on dry surfaces

Speed (km/h)	Water Depth	Tyre Description	Macro Texture	Longit. Friction value	Longit. Slip (%)	Tyre Load (N)	Note
Pavement section N.1							
80	0	A	0.56	0.76	100	4000	
80	0	B	0.56	0.73	100	4000	
80	0	C	0.56	0.72	100	4000	
80	0	B	0.56	1.06	100	4000	outlier
		Average	PAV1	0.82			
		Average	PAV1 (w/o outlier)	0.74			
Pavement section N.2							
80	0	A	0.58	0.74	100	4000	
80	0	B	0.58	0.67	100	4000	

80	0	C	0.58	0.73	100	4000	
80	0	B	0.58	0.76	100	4000	
		Average	PAV2	0.72			
Pavement section N.3							
60	0	D	0.95	0.70	100	3500	
60	0	E	0.95	0.73	100	3500	
60	0	B	0.95	0.64	100	3500	
60	0	A	0.95	0.65	100	3500	
		Average	PAV3	0.68			
			Average	0.74			
			Average (w/o outlier)	0.71			

The potential benefits of using such increased friction values could be enormous, as shown in the example of Figure 25, referred to the most critical conditions (4% downhill slope) in a type A left-hand bend. In this case, in fact, considering a constant friction coefficient of 0.70, the maximum enlargement is still related to the curve with radius of 964m but it drops from 5.40m to only 1.10m.

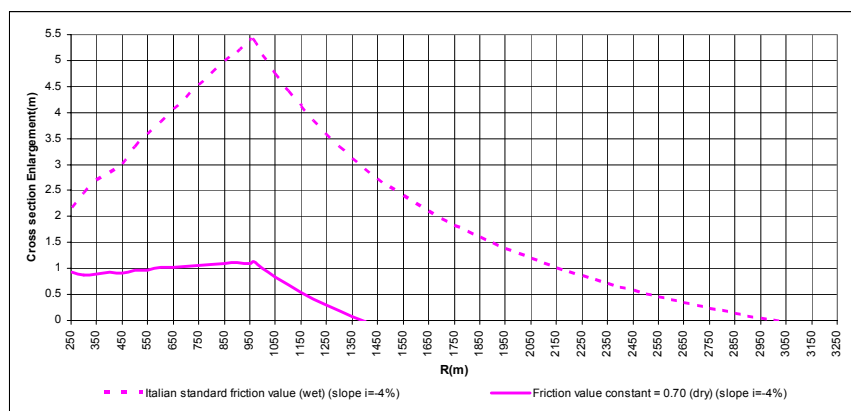

Figure 25: Example of Enlargements Vs Radii for left-handed curves in Type A Roads in dry and wet conditions

To assess the possibility to fully exploit the advantages offered by using dry friction values in tunnels, detailed tests should be performed. As a matter of fact, inside road tunnels, smoke and pollution should rather reduce, instead of increase, the actual friction values available at the type-road interface.

To investigate this issue a statistical analysis has been developed on some friction coefficients (SFC) measured with SCRIM device, both inside and outside highway tunnels and grouped together for similar types of pavement surfaces.

The following types of pavements were considered:

- traditional asphalt concrete wearing course (31 km of road measured outside tunnels and 5 km inside)
- surface course realized with microsurfacing (82 km outside tunnels and 1.5 km inside)
- surface course realized with macroseal (96 km outside tunnel and 4 km inside)

As prescribed by the Italian standard CNR [12], SCRIM side direction values are measured in standard wet surface conditions.

For each type of pavement, 2 samples of measures have been considered, one referred to friction outside tunnels (sample 1) and one to friction inside tunnel (sample 2). Each sample has been described in terms of mean (μ_1 and μ_2), standard deviation (σ_1 and σ_2) and number of observations (n_1 and n_2) as synthesized in Table 5.

Table 5: SFC samples description in terms of mean, standard deviation and number of observations

SFC	MICROSURFACING		TRADITIONAL AC WEARING COURSE		MACROSEAL	
	OUTSIDE	INSIDE TUNNELS	OUTSIDE	INSIDE TUNNELS	OUTSIDE	INSIDE TUNNELS
Mean	0.52	0.51	0.52	0.48	0.58	0.54
St. Dev	0.062	0.047	0.079	0.066	0.063	0.055
n	6605	119	2480	396	7724	160

Considering the great number of observations available for the different samples, normal distributions have been assumed to describe friction values both inside and outside tunnels for a given type of pavement, that are represented in Figure 26.

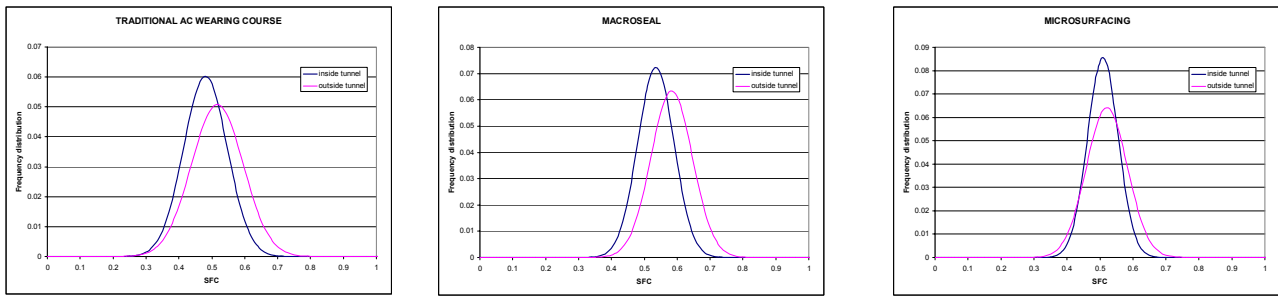

Figure 26: Normal distributions of SFC measures inside and outside tunnels for the different type of pavements

For each type of pavement an hypothesis testing on the equality of the 2 samples distributions have been developed in order to evaluate if the average friction values inside and outside tunnels can be considered equivalent.

The test was based on the acceptance of the null hypothesis $H_0 (\mu_1 - \mu_2 = 0)$ against the alternative hypothesis $H_1 (\mu_1 - \mu_2 \neq 0)$.

Using the standard deviation σ_1 and σ_2 of each of the two samples the test statistic has been formed using the following equation (Eq. 7)

Eq. 7
$$Z = \frac{\mu_1 - \mu_2}{\sigma_{\bar{X}_1 - \bar{X}_2}} \quad \text{where} \quad \sigma_{\bar{X}_1 - \bar{X}_2} = \frac{\sigma_1^2}{n_1} + \frac{\sigma_2^2}{n_2}$$

The Z-test leads to accept the H_0 hypothesis when the Z value is not contained in the critical region that is the area related to the significance level accepted for the test in a normal distribution. For this analysis the significance level assumed is $\alpha = 0.05$ that is associated to the critical region external to the values -1.96 and 1.96 for two-sided tests (Figure 27).

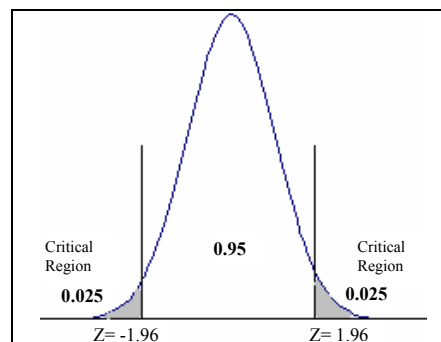

Figure 27: Critical region in a normal distribution $\alpha = 0.05$

If the test Z value results to be inside the critical region the test indicates that H0 is rejected with a probability greater than 95% if, on the contrary, the Z value is outside the critical region it means the H0 hypothesis can be accepted for the defined significance level.

The test results showed in Table 6 indicate that the H0 hypothesis must be rejected for all the 3 types of pavements considered.

In conclusion the statistical tests on SFC values show that the means of friction samples measures are different inside and outside tunnels for similar pavement surfaces. In particular from Table 5 and Figure 26, it can be assumed that friction inside tunnel is general lower than the one outside This as said earlier is likely due to the presence of smokes and pollutions inside the tunnels.

Table 6: Z-Test equality of 2 samples means results for CAT measures

TEST Z				
H0 : ($\mu_1 - \mu_2 = 0$); H1: ($\mu_1 - \mu_2 \neq 0$)				
	$\sigma_{\bar{X}_1 - \bar{X}_2}$	Z	Significance level	Test result
TRADITIONAL AC WEARING COURSE	0.368623	9.81	0.05 (Z=1.96)	H0 rejected
MICROSURFACING	0.434158	2.81	0.05 (Z=1.96)	H0 rejected
MACROSEAL	0.441111	10.93	0.05 (Z=1.96)	H0 rejected

Given these results it can be concluded that the actual tyre-road friction values inside the tunnels are lower than outside and therefore assuming the 0.7 longitudinal friction values derived from open air sections can lead to underestimate the RSD values. On the other hand the impact of using dry friction coefficients is so high (see Figure 25) that even a reduced dry friction coefficient specifically referred to tunnels could result in improving considerably the visibility issues. As a matter of fact there are no data available for the definition of such friction values and a specific testing survey in tunnels should be set up to solve this issue.

USE OF HANDLING SIMULATION TOOLS

All the considerations above are based on the application of the design requirements included in the Italian standard which are based on two basic assumption:

- the breaking distances defined considering the vehicle as a “moving point” with a given speed and mass;
- the available longitudinal friction is considered independent from the actual side friction required for bending.

The application of handling simulation tools, such as the one under development in the VERTEC project [9], will enable in a few years from now to evaluate the actual breaking distance in a specific location and for a specific wearing course to be compared with the locally available sight distance.

This approach could be used to better calibrate the enlargement requirements and the efficiency of mitigation measures.

CONCLUSIONS

The analysis conducted has shown that insuring sight distances in tunnels leads to realize enlargements in curves that for the considered road types (type C secondary roads and three lanes type A rural motorways) can reach values of 5 to 7.80m. These enlargements lead to an increase in the tunnel excavation costs that can reach almost 270% of the cost of the base section. Such a cost increase will likely be considered not feasible and some design issues or mitigation measures should be evaluated to limit the construction cost increase.

The first option for controlling the required enlargements, and therefore the increase in excavation costs, is to avoid, at a design stage, the worst plano-altimetric combinations. This issue can be tackled considering cost increase Vs curvature diagrams for different longitudinal slopes. With this approach fixing the maximum

allowed cost increase it is possible to define the ranges of curvature radii that, for a given type of road, have to be avoided for a certain longitudinal slope. As an example assuming for type A roads a maximum allowed cost increase of 25% right-hand bends have problems only for steep downhill grades and curves radii between 750 and 1100m. Differently for left-hand bends the maximum assumed increase in costs leads to avoid radii below 1200m (in steep uphill) to 1550m (in steep downhill) which still seems an unacceptable design constrain. In such cases some “mitigation” measures could be considered to control the additional risks introduced by the visibility problem.

In this study the following issues have been analyzed:

- Enforcing the speed limit inside tunnels by means of cameras, laser or radar devices. In this case the required stopping distance (RSD) could be considered with reference to the legal speed limit instead of the maximum design speed with the consequence that the maximum required enlargements for type A roads decrease of more than 10% and for type C roads of more than 20%.
- Imposing acceptable speed limits in restricted road portions. In order to define the possible speed limit to be posted in a given type of road with a defined longitudinal slope, the actual required enlargements for any speed limit have to be defined. The speed limits to be posted should derive from a compromise between the limitation in cost increase and the need for allowing the drivers to travel at an acceptable speed.
- Controlling risk increase. In the assumption of accepting a limited level of risk associated with a lack of visibility it is possible to adopt a speed limit small above the one that actually guarantee that the RSD is equal to the available sight distance (ASD).
- Increasing friction coefficients. A specific analysis has been conducted to evaluate if dry friction values could be considered in tunnels instead of wet friction values in case of waterproofed tunnels. The analysis on this issue has shown that the actual tyre-road friction values inside the tunnels are lower than outside. This lead to the consideration that assuming a dry friction value derived from open air sections can lead to underestimate the RSD values. On the other hand the impact of using dry friction coefficients is so high that even a reduced dry friction coefficient could result in improving considerably the visibility issues. As a matter of fact there are no data available for the definition of such friction values and a specific testing survey in tunnels should be set up to investigate this issue.
- Using of handling simulation tools. These new tools could be used in order to evaluate the actual breaking distance in a specific location and for a specific wearing course for a more accurate evaluation of RSD and therefore to estimate the actual lack of visibility.

REFERENCES

- [1] D.M. n.6792, 05/11/2001, Italian National Standard on Road Geometric Design.
- [2] D.L. n.285, 30/04/1992, “Nuovo Codice della Strada”.
- [3] M. TANZINI – *Gallerie: aspetti geotecnici nella progettazione e costruzione*, ed. Flaccovio, 2001.
- [4] WALTER STEINER – *Mechanized construction of large diameter tunnels in Switzerland*, VII Conference Cycle on Rock Mechanics and Rock Engineering: “Mechanized tunnelling”, Turin 2000.
- [5] S. FUOCO, P. MAZZALAI – *Lo sviluppo delle gallerie di grandi dimensioni , lo scavo meccanizzato*, Sws Engineering S.p.A., 2002.
- [6] FILIPPO BARTUCCI – *Analisi della sicurezza nella costruzione di gallerie: il caso dei cantieri fiorentini dell’alta velocità a Sesto Fiorentino*, Degree Thesis in Civil Engineer, University of Florence, 2004, supervisors P. Capone, L. Domenichini.
- [7] VITTORIO COLOMBINI – *Procedimenti costruttivi per la realizzazione di gallerie nelle infrastrutture stradali*, University of Rome “La Sapienza”, 1984.
- [8] ANG ALFREDO, TANG WILSON – *Probability concepts in engineering planning & design*, Vol.I- Basic Principles, Ed. John Wiley & sons, 1975.
- [9] VERTEC Project, www.vertec.hut.fi.
- [10] L. DOMENICHINI, F. LA TORRE, F. MANCOSU – *The use of handling simulation tools for road design and management*, SURF 2004.

- [11] L. DOMENICHINI, F. LA TORRE – *Risk analysis for speed inconsistencies of roads*, submitted to SIIV 2004.
- [12] CNR 147/1992: *Norme per la misura delle caratteristiche superficiali delle pavimentazioni: metodo di prova per la misura del coefficiente di aderenza con l'apparecchio S.C.R.I.M.*
- [13] AA.VV. – *Research Paper: A cost recovery system for speed and red-light cameras, two years pilot evaluation*, U.K. DEPARTMENT FOR TRANSPORT, 2003.