



UNIVERSITÀ
DEGLI STUDI
FIRENZE

FLORE

Repository istituzionale dell'Università degli Studi di Firenze

Correlations between the evolution of contradictions and the law of ideality increase

Questa è la Versione finale referata (Post print/Accepted manuscript) della seguente pubblicazione:

Original Citation:

Correlations between the evolution of contradictions and the law of ideality increase / N. Becattini; G. Cascini; F. Rotini. - ELETTRONICO. - Proceedings of TRIZ Future Conference 2009:(2009), pp. ---. (Intervento presentato al convegno TRIZ Future Conference 2009 tenutosi a Timisoara, Romania nel November, 4th - 6th, 2009).

Availability:

This version is available at: 2158/376611 since: 2015-10-27T14:58:42Z

Publisher:

--

Terms of use:

Open Access

La pubblicazione è resa disponibile sotto le norme e i termini della licenza di deposito, secondo quanto stabilito dalla Policy per l'accesso aperto dell'Università degli Studi di Firenze (<https://www.sba.unifi.it/upload/policy-oa-2016-1.pdf>)

Publisher copyright claim:

(Article begins on next page)

Correlations between the evolution of contradictions and the law of ideality increase

Niccolò Becattini¹, Gaetano Cascini¹, Federico Rotini²

¹Politecnico di Milano, Dip. di Meccanica, Italy

²Università degli Studi di Firenze, Dip. di Meccanica e Tecn. Ind.li, Italy

Abstract

TRIZ literature largely claims the efficiency of Altshuller's Laws of Engineering System Evolution (LESE) as a means for producing technology forecasts. Besides, all the instruments and the procedures proposed so far suffer from poor repeatability, thus limiting the adoption of TRIZ instruments as reliable means for the analysis of emerging technologies and their potential impact. In a previous work [1, 2] the authors have presented their modelling approach based on a combination of well known TRIZ techniques and traditional engineering design reference models. The outcome is a Network of Evolutionary Trends which supports decision making by positioning alternative technologies and technical solutions according to the LESE. The choice of the favourite strategic direction is still assigned to the beneficiaries of the forecast, since decisions will be taken also based on their mission and values. Besides, it is necessary providing further means of judgement to the decision makers. According to this purpose, it is useful to assess the maturity level of the analyzed technologies. The present work is a study about the correlations existing between the evolution of contradictions and the Law of Ideality increase, as a means to estimate the stage of development of a Technical System. The paper details the method proposed to make a systematic comparison of the contradictions related to each technology. The approach is clarified by means of a case study related to the production of tablets in the pharmaceutical manufacturing sector.

Keywords

Technology Forecasting, Laws of Engineering Systems Evolution, Contradictions

1 INTRODUCTION

TRIZ is founded on three postulates: (i) the existence of objective laws (LESE) governing the evolution of Technical Systems (TS); (ii) the refusal of compromises and the advancement of TS through the resolution of contradictions, i.e. conflicts between a system and its environment or between the components of the system itself; (iii) the impact of the specific situation, i.e. the resources which determine the concrete means to develop more evolved solutions.

Nevertheless, a paradoxical dichotomy characterizes most of TRIZ works: those focused on problem solving tasks, take into account the concept of contradictions, but practically neglect any relationship with the LESE, despite an appropriate application of ARIZ hiddenly implies the respect of the LESE. Vice versa, evolutionary analyses and "technology forecasting" applications are just based on the directions inspired by the LESE and/or by a few trends (e.g. the Inventive Standards of Class 2 and 3), but the notion of contradiction is missing. Somehow the resources (third postulate) are usually taken into account in both the applications.

The necessity to integrate the analysis of contradictions with the LESE in any TRIZ-based study has been already highlighted in previous works (e.g. [3, 4]), but just preliminary directions are emerging about the way to harmonize them. The present paper provides a contribution in this context through a study about the correlations existing between the evolution of contradictions and the fourth Law of Evolution (Ideality increase).

Such a correlation is a valuable resource to assess the maturity of a certain technology and it is proposed as a decision aid when multiple directions emerge from an evolutionary analysis made through the TRIZ LESE.

The present paper first positions the present research in comparison with other publications related to contradiction analysis and TS evolution. Then the third section

summarizes the modelling technique, already discussed in [2], which aims at improving the repeatability of TRIZ-based evolutionary analyses. Section 4 details the original approach here proposed to identify the contradictions characterizing the evolution of the technologies to be compared and the related correlation analysis. In section 5, these criteria are applied to the past and current technologies adopted in the pharmaceutical manufacturing sector for tablets production. The case study allows to discuss about the potentiality to adopt the proposed correlation analysis as a means for maturity assessment.

2 EVOLUTION OF TECHNICAL SYSTEMS AND RELATED CONTRADICTIONS

The evolution of Technical Systems follows objective laws and overcoming contradictions is the inherent mechanism which determines TS development. The first two postulates of TRIZ are clearly strictly related to each other; nevertheless, their coexistence is just "perceivable" into the classification of the Inventive Standards, while it is almost hidden in ARIZ, as well as in other items of the TRIZ body of knowledge.

As a matter of facts, in classical TRIZ there are no formalized tools to correlate the evolution of a TS with its contradictions: in [5] Altshuller, through the well known curves of system development, number of inventions, profitability, level of inventiveness (figure1), implicitly highlighted the conceptual link existing between the maturity of a TS and its contradictions, since the latter index is measured through the degree of contradiction resolution. Besides, these curves are hardly usable for practical scopes, despite what has been claimed in several publications like [6-8], also due to the lack of information about the way Altshuller himself built them (therefore, with no references about their limits of validity). In facts, in these papers the technology maturity curves are usually fuzzily rebuilt, often with relevant details missing (e.g. x and y values in [6]), and with extremely doubtful determination of the inventiveness level [7, 8].

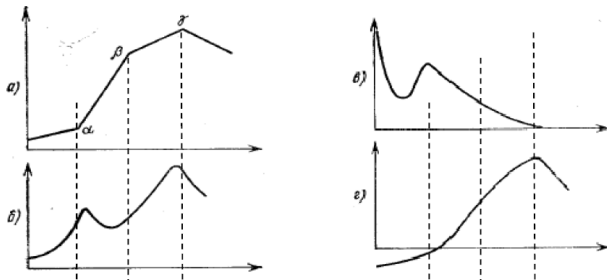

Fig. 1. Correlation between the stages of the "life" S-curve of a technical system (top, left) with the number of inventions (bottom, left), the level of inventiveness (top, right) and the related benefit, i.e., profitability (bottom, right) [5].

Indeed, numerous attempts have been accomplished to systematize the count of inventions, but just time consuming manual analyses allow to filter out not relevant patents selected through standard computer search criteria. The determination of the Level of Inventiveness evolution is even more difficult, since it is supposed to be done through a careful identification of the contradictions behind the problem solved by the patented inventions and, most of all, by the assessment of the degree of elimination of the contradictions themselves, which is extremely time consuming. Besides, no practical means still exist to speed up the identification and assessment of the contradictions approached by a patented invention, despite preliminary studies have been published in [9].

According to these issues, it emerges the necessity to find out further correlations between the maturity stage of a technology in a certain field of application and other technical information, possibly manageable with computer means to improve the efficiency of the process.

Out of TRIZ literature, Technology Assessment (TA) has greatly evolved since the early experiences of the 1960s [10], but still there isn't a single, widely disseminated and applied methodology. Many different approaches to TA have been adopted in practice, depending on the specific aims and scope of the application and its context (institutional, private firms, private or public research centres, specific industries etc.) [11]. Due to the lack of an established TA approach, neither in the scientific literature, nor in the industrial practice, the authors have decided to investigate the possibility to correlate the maturity of a technology with the evolution of the contradictions underlying its application in a certain field. The existence of such a correlation is expected according to the fifth law of evolution (uneven development of TS parts) and addressed also by Cavallucci and Rousselot [3], where the purpose is indeed different: ordering the contradictions in accordance to the fact that they present an opposition to a specific law.

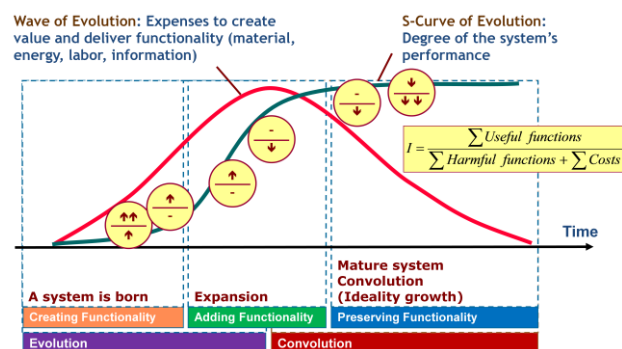

Fig. 2. Trend of Ideality increase (red line) compared with the consumption of resources (green line) which reflects the wave model by Salamatov [5].

In this paper the search for correlations between the evolution of TS contradictions and the LESE has been focused on the law of Ideality increase, due to some evidences arising from classical TRIZ literature. In facts, the growth of the degree of ideality can be compared with the consumption of resources according to the wave model by Salamatov [12], as depicted in fig. 2. By combining the S-curve of TS performance with such a bell shape resources consumption three main stages of evolution can be recognized. The specific objective of the present research is to check the possibility to correlate the nature of the contradictions acting on a TS with these stages of TS development.

3 FUNCTIONAL MODELING FOR TRIZ-BASED EVOLUTIONARY ANALYSES

With the aim of improving the repeatability of TRIZ-based evolutionary analyses, the authors have proposed in [1], then further detailed in [2], a functional modelling approach which integrates well known models and instruments for system description and function representation and allows a systematic application of the TRIZ LESE to classify existing technologies and to identify further opportunities of development through a Network of Evolutionary Trends (NET).

The modelling procedure is based on the following reference models:

- Function-Behavior-Structure (FBS) model [13], to distinguish between the Function of a TS, i.e. the motivation of its existence, its Behaviour, i.e. the way the function is delivered according to the Laws of Nature, and the Structure, a combination of entities, attributes of these entities and relations among them, which determine the Behaviour of the TS.
- EMS (Energy, Material, Signal) model [14], to describe the Function of System and Subsystems.
- NIST Functional Basis for Engineering Design [15], to reduce ambiguity at the modelling level and to improve repeatability of the models through a taxonomy of actions and flows coherent with the EMS modelling approach.
- An extension of the classical TRIZ model of Minimal Technical System (MTS) [5], to represent the Behaviour of the TS also through Material and Signal flows (from the supply to the Tool through the Transmission).
- System Operator [5] to conduct the analysis at different detail levels (i.e. system, sub-systems etc.) with a proper hierarchical classification of system elements, by taking into account their Behaviour and modifications in time.

A detailed description of the modelling algorithm is out of the scopes of the present paper. Nevertheless, it is worth to mention its main steps:

1. The system is modelled through EMS boxes and decomposed into elementary functions until each functional unit can be described in terms of flows and actions belonging to the reference list proposed in [15] (fig. 3).
2. Then the Behaviour of each elementary function is represented by means of the TRIZ model of Minimal Technical System as follows (fig. 4):
 - a. identify the Product, i.e. the object of the function which determines a transformation of the input flow into the output;
 - b. identify the Tool, i.e. the element which acts directly on the Product;

- c. determine which properties characterize the Tool's capability to deliver the function to the Product;
 - d. for each of the properties defined at step 2c, identify the "Engine" from where the properties derives;
 - e. complete the model of the minimal technical system, by adding the transmission from the Engine to the Tool, the control and its interactions with the other subsystems and the external supply of the engine.
3. Once that the available Behaviours have been modelled for each elementary function, a Su-Field model related to the interaction of each pair of interacting elements of the Minimal Technical System model is added (i.e. Tool-Product, Control-Tool etc.).
 4. Identify the Evaluation Parameters defining the performance of each elementary function of the TS modelled at step 1.
 5. Identify further Evaluation Parameters related to the harmful functions and the resources consumption of each Behavioural Models built at step 2.
The last two steps are part of the original contribution of the present paper and will be further detailed in the next section.

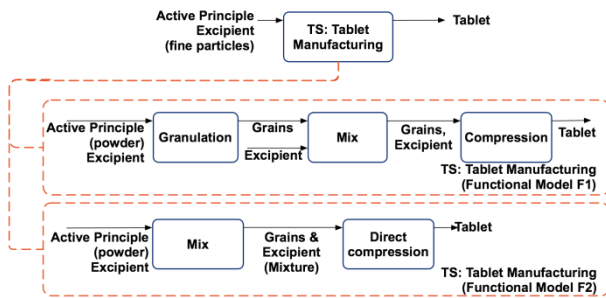

Fig. 3. Functional model of a pharmaceutical tablet manufacturing process: EMS functional decomposition.

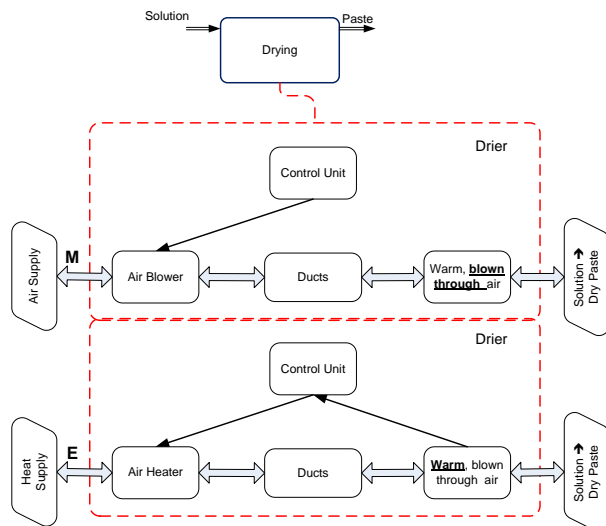

Fig. 4. Exemplary Behavior represented through the model of the Minimal Technical System associated to an elementary function described through the EMS model [2].

4 CORRELATING TS CONTRADICTIONS AND EVOLUTIONARY STAGES

In order to explain the proposed approach to study the existence of correlations between the evolution of the contradictions characterizing a certain TS and its stages of development, it is worth to recall the model of a TRIZ contradiction. The authors have adopted the OTSM formulation [16], which distinguishes between Evaluation

and Control Parameters (fig. 5): <Control Parameter> of <Element X> should assume <Value 1> in order to improve <Evaluation Parameter 1> of <Element Y>, but then <Evaluation Parameter 2> of <Element Z> worsens; <Control Parameter> of <Element X> should assume <Value 2> (with <Value 2> ≠ <Value 1>) in order to improve <Evaluation Parameter 2> of <Element Z>, but then <Evaluation Parameter 1> of <Element Y> worsens.

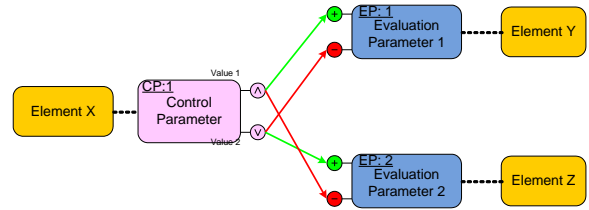

Fig. 5. OTSM-TRIZ model of contradiction [16].

Aiming at the highest repeatability of the analysis, it is proposed to identify and classify the Evaluation Parameters (EP) of each Function/Behaviour according to a set of well defined rules; similarly, the Control Parameters (CP) of each Behavioural Model (BM) are clustered on the base of general rules as detailed below. Eventually, it is necessary to check the relationships between CPs and EPs in order to identify the contradictions characterizing each BM.

4.1 Clusters of Evaluation Parameters

The Evaluation Parameters represent the overall list of requirements to be satisfied by the TS and the means to assess its degree of Ideality.

According to such a definition, some Evaluation Parameters assess the Performance of the function delivered by a TS. By definition, these parameters are just related to the function accomplished by the TS and not to its Behaviour and Structure, i.e. the way the function is delivered. Besides, other EPs represent a measure of the undesired side effects (harmful functions) and the consumption of resources to make the system work. It is clear that the latter two categories of EPs strongly depend on the nature of the Behavioural Model and the Structure of the TS.

Therefore, the authors have defined a standard classification of each class of EPs:

- Performance of the Main Useful Function and of other Useful Functions delivered by the TS;
- Harmful Functions;
- Resources consumption.

The cluster of Performance EPs can be divided into four sub-classes:

- Threshold achievement: capability to impact the object of the function with the expected extent (in order to consider the function as "sufficient");
- Versatility: parameters that characterize the capability to adapt the behaviour according to different operating conditions;
- Robustness: parameters that take into account the capability to have the same desired outcome under varying inputs;
- Controllability: parameters that consider the capability to set the function desired outcome according to the user will.

The Harmful Function cluster is divided into three different sub-classes, considering negative impacts on:

- object of the MUF (e.g. an undesired side effect caused by the same mechanism adopted to deliver the MUF);

- system and subsystems integrity (e.g. an undesired side effect on the TS or its parts, caused by the mechanism adopted to deliver the MUF);
- the external environment (e.g. an undesired side effect on the super-system caused by the mechanism adopted to deliver the MUF).

Finally, the EP related to Resources consumption are classified into five sub-clusters:

- Space;
- Time;

- Information;
- Material;
- Energy.

It is worth to notice that a comprehensive definition of the EPs related to HF and resources, should take into account also the auxiliary functions (AF) necessary to deliver the MUF, elicited during the modelling phase (from Function to Behaviour and Structure).

Figure 6 summarizes with a flow chart the EP classification process.

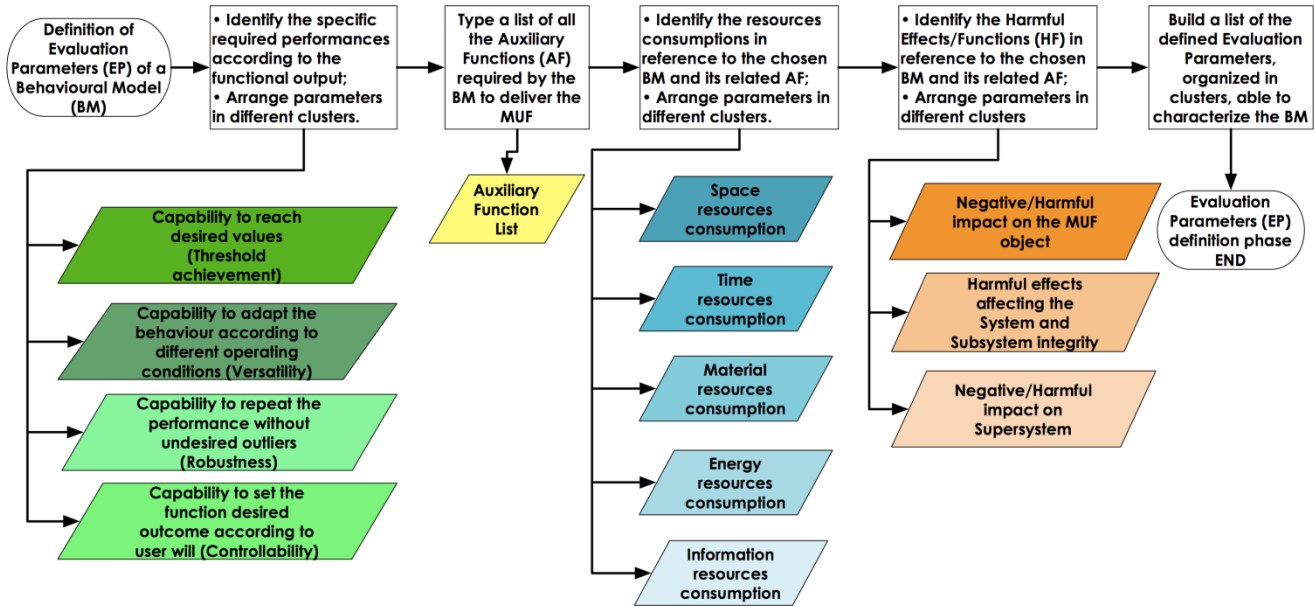

Fig. 6. Algorithm for EP classification.

4.2 Clusters of Control Parameters

The Control Parameters, i.e. the design parameters that can be modified to impact on the EPs, clearly depend on the Behaviour and the Structure adopted to deliver a certain Function. Nevertheless, even in this case, the authors have proposed a reference categorization described here below.

More in details, two main classes of CPs are recognized:

- CP related to the EMS flows processed by the TS under study;
- CP related to the MTS model of the TS under study.

Both the above categories of CPs can be further distinguished according to the following classification criteria:

EMS flows

- The classification of EMS flows adopts the same schema proposed in [15] by NIST, i.e. a hierarchical three levels taxonomy including 6 secondary and 11 tertiary material flows, 12 secondary and 4 tertiary energy flows, 2 secondary and 7 tertiary signal flows.

MTS elements

- Nature of the Effect underlying the Behaviour of the TS. The CPs can be classified according to the type of effect they are associated with: Chemical Effects enable to obtain some substances from others by the absorption or isolation of energy; Physical Effects enable to transform one form of energy into another; Geometrical Effects organize and redistribute flows of energy and substances that are already available in the system.
- Role in the Behavioural Model according to the MTS schematization: the CPs are classified according to

the element they are referred to, among Tool, Transmission, Engine, Control.

- Type of resources: the CPs modify the way the resources are used to improve the satisfaction of the EPs; therefore they can be classified according to the type of resource involved on, as described also for the EPs: Space, Time, Information, Material and Energy.

4.3 Contradictions characterizing a Behavioural Model

Before detailing the approach here proposed, it is worth highlighting that the goal of the present task is not solving contradictions, but modelling, counting and classifying them as a means to search for correlations with the maturity level of a TS.

As mentioned above, the reference model is the OTSM-TRIZ schema shown in fig. 5. Therefore, an elementary contradiction involves 1 CP and 2 EPs, such that opposite values are required to the CP itself in order to improve the two EPs alternatively.

Once that the lists of CPs and EPs have been built as described in the previous sections, it is necessary to assess the potential impact of each CP on each EP; then it is checked if a certain variation of a CP determines contradictory modifications on two or more EPs. More in details, the following steps must be accomplished:

1. Identify two opposite values for each CP and choose a reference orientation (e.g. from small to big, property Vs anti-property etc.).
2. Assess the impact IMP_{ij} of a CP_i variation on each EP_j (to be repeated for each CP_i):
 - $IMP_{ij} = +1$ if a variation of CP_i towards the selected reference direction determines an improvement of EP_j;

- $IMP_{ij} = -1$ if a variation of CP_i towards the selected reference direction determines a worsening of EP_j ;
- $IMP_{ij} = 0$ if a variation of CP_i doesn't impact on EP_j .

Figure 7 (above) clarifies the meaning of such a classification.

3. The overall number of elementary contradictions related to a certain CP_i can be evaluated as follows:

$$CNTD(CP_i) = (\# \text{ of } IMP_{ij} = +1) \times (\# \text{ of } IMP_{ij} = -1) \quad (1);$$

in other terms, a complex contradiction involving a CP and several EPs can be decomposed in $CNTD(CP_i)$ elementary contradictions (figure 7, below).

4. The overall number of contradictions related to the k -th behavioural model BM_k is evaluated as the sum of the contradictions related to each of its CPs:

$$CNTD(BM_k) = \sum CNTD(CP_i^k) \quad (2).$$

According to the goal of the present paper, it is interesting to analyze the evolution of $CNTD(BM_k)$ in the history of development of a certain TS. Similarly, it is worth to study the evolution of specific subsets of contradictions, defined according to the type of their EPs and/or CPs.

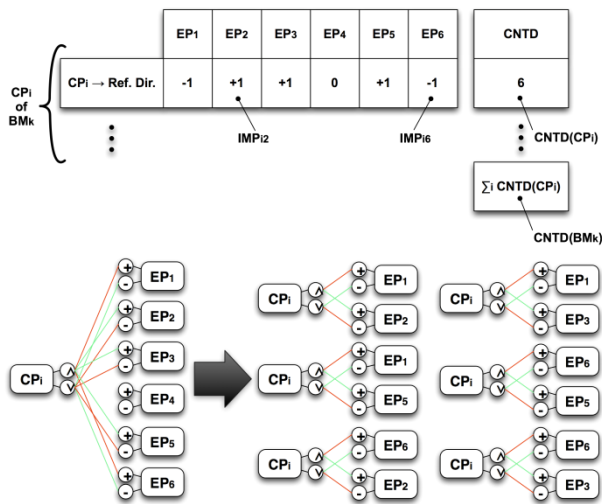

Fig. 7. Decomposition of complex contradictions.

4.4 Clusters of Contradictions

In this paper the analysis of contradictions evolution is focused on the nature of their EPs, due to their closed connections with the Law of Ideality Increase. In facts, the three main clusters of EPs defined in section 4.1, i.e. performance of the main useful function, harmful functions, resources consumption, can be directly linked to the concept of Ideality (fig. 2). Function performances, intended as desired outcomes, can be related to the Ideality dividend; on the other hand "harmful function" and "costs" constitute its denominator.

Therefore, it is possible to organize the contradictions in clusters according to the type of their EPs conflicting pair, hence obtaining six different types of contradictions:

- Performance (P) vs. Performance (P);
- Performance (P) vs. Harmful Functions (HF);
- Performance (P) vs. Resources Consumptions (RC);
- Harmful Functions (HF) vs. Harmful Functions (HF);

- Resources Consumptions (RC) vs. Harmful Functions (HF);
- Resources Consumptions (RC) vs. Resources Consumptions (RC).

In analogy with the determination of the total number of contradictions associated to a certain BM (2), it is possible to calculate the contradictions separately for each of the 6 above listed classes, by taking into account the following recommendations:

- the count of IMP_{ij}^m should be limited to the EP_j of a specific class m , where m is alternatively P, HF, RC;
- therefore, (2) is updated as follows:

$$CNTD_{m,n}(BM_k) = \sum (\# \text{ of } IMP_{ij}^m = +1) \times (\# \text{ of } IMP_{ij}^n = -1) \quad (3)$$

where, $CNTD_{m,n}(BM_k)$ is the number of contradictions involving an EP of class m and an EP of class n associated to the Behavioural Model k .

Similarly, since in section 4.1 twelve different classes of EPs have been defined, a total number of 78 permutations of EP pairs can be defined, thus producing 78 subsets of contradictions to be counted according to (3) for a more detailed analysis of contradiction evolution, as discussed below.

4.5 Evolution of Contradictions

In the study of the evolution of a TS, once that its functional analysis has been accomplished according to the criteria summarized in section 3, it is possible to evaluate the number of contradictions of each Behavioural Model as detailed in section 4.4.

The rationale of this analysis is the attempt of correlating the nature of the contradictions with the stage of development of the different BMs of a given TS. Indeed, different types of EPs are supposed to be involved in a different manner along the evolution from the infancy stage to the maturity. For example, according to the wave model by Salamatov [12] shown in fig. 2, the consumption of resources changes with a definite regularity.

However, due to the complexity of the possible situations, the authors don't intend to perform any assumption about possible regularities between contradictions and stages of development. Besides, it is proposed to apply the same classification to a number of case studies in order to check the existence of correlations between them.

Such an activity clearly implies an extensive work to be done for a proper validation; nevertheless, according to the limitations of the current approaches for maturity assessment mentioned in section 2, it is worth to dedicate adequate efforts to the initiative.

5 EXEMPLARY CORRELATION ANALYSIS BETWEEN EVOLUTION OF CONTRADICTIONS AND TS DEVELOPMENT

The authors have already experienced the NET modelling approach in four case studies related to disabled walkers, wood pellets production, aseptic filling of beverage containers and tablets production; in each of these case studies conducted from September 2007 to March 2009 the role of the authors was the definition of a structured set of scenarios to support company's management in the selection of the most appropriate directions for investment. The algorithm was carefully applied to collect and classify the implicit knowledge of company's experts, as well as to direct the search for further relevant information from patent databases and other scientific

sources. Two further extended applications are in progress.

In this section the proposed classification and correlation analysis is applied to the case study in the field of production of tablets in the pharmaceutical manufacturing sector, since several technologies have been developed in the last decades and it is possible to appreciate the substitution process of emerging techniques over mature ones.

5.1 Functional and Behavioral Modeling

The tablet production process consists in agglomerating the Active Principle Ingredients (API) from a powder status into pills. All the existing technologies make use of excipients to improve the manufacturability and the conservation properties of the drug. Two main classes of processes can be distinguished: the largest majority of current production plants make use of an intermediary granulation phase to ease the moldability of the raw materials (fig. 8).

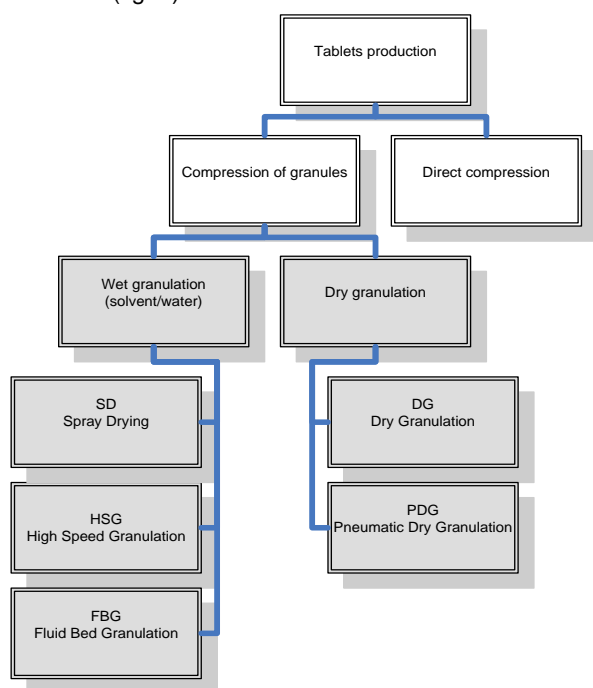

Fig. 8. General classification of tablets production technologies, based on the compression (white boxes) and the granulation (gray boxes) phases.

Recently, direct compression has been applied to some APIs. Figure 3 shows the EMS model of the whole process and the functional decompositions characterizing these two major techniques. Due to the availability of detailed information from the industrial partner of the present study, a particular attention has been dedicated to the granulation phase. In the past, granulation was performed through the production of a solution to be homogenized, dried and eventually reduced to granules. After the introduction of severe limitations about solvents usage, wet granulation technologies have adopted water to substitute solutions with particle suspensions, but still keeping the same machinery. Recently, dry granulation processes have been proposed to reduce the harmful impact of water residuals into the tablets and to improve the efficiency of the overall production process. Therefore, the detailed analysis has been performed on the following technologies: High Speed Granulation (HSG), Fluid Bed Granulation (FBG), Spray Drying (SD), Dry Granulation (DG), Pneumatic Dry Granulation (PDG) (fig. 8).

Each of the five granulation technologies has been decomposed into elementary functions according to the NIST classification, as described in section 3. Due to space limitations it is not possible to show all the functional and behavioural models built; however, it is worth to list the identified elementary functions, since they will constitute the main object of the evolutionary comparison between maturity level and contradictions types.

- HSG: Mixing (API, excipients, water), Fragmentation, Drying, Fragmentation, Sifting;
- FBG: Mixing (API, excipients), Fluidize, Agglomerate, Drying, Filtering;
- SD: Mixing (API, excipients, water), Atomizing, Drying, Sifting;
- DG: Mixing (API, excipients), Compacting, Pre-crushing, Flake Crushing, Sifting;
- PDG: Conveying (API, excipients), Compacting, Pre-crushing, Flake Crushing, Fraction.

Then, each of the elementary function has been analyzed in order to build its Behavioural Model through one or more Minimal Technical System models, as depicted in fig. 4. As a result, 14 different BMs have been recognized:

- BA1: agglomeration of fluidized powders by means of a liquid binder in a closed bin (Fluid Bed Agglomeration);
- BC1: powders compressed into a ribbon by means of two opposite counter rotating rollers (Roller Compaction);
- BD1: pneumatic conveying of particles/powders;
- BM1: mechanical mixing of powders and binders by means of moving surfaces ;
- BM2: pneumatic mixing of powders by fluidization (fluid bed mixing);
- BM3: mixing of powder by means of moving surfaces;
- BF1: mechanical fragmentation of wet mass by means of calibrated nets;
- BF2: mechanical fragmentation of dry compacts (slugs or flakes) by means of oscillating rollers: oscillating granulation;
- BF3: flakes spherization;
- BS1: Vibro-sieving;
- BS2: PDG "smart" fractioning;
- BS3: cyclone separation;
- BE1= fluid bed drying;
- BE2= dehydration by means of a flow of warm air (oven drying).

Eventually, the EPs and CPs related to each BM have been identified: first, performance EPs are associated to each elementary function, according to the classification described in section 4.1. Then, the specific characteristics of each BM are analyzed to identify relevant resources and related harmful functions. Similarly, each MTS allows to extract the CPs impacting the behaviour of the related technology.

As a result, an elementary function characterizing different technologies (e.g. mixing, drying, sifting etc.) is evaluated through the same performance EPs, but possibly different resources and harmful functions EPs depending on the specific way the function is performed (behaviour). Fig. 9 depicts an exemplary analysis referred to the elementary function "mixing": above it is represented the EMS model, with details about the reference flows and actions according to the NIST classification. Six performance EPs are associated to the function, four aimed at evaluating the achievement of the useful result, three related to robustness, adaptability and controllability.

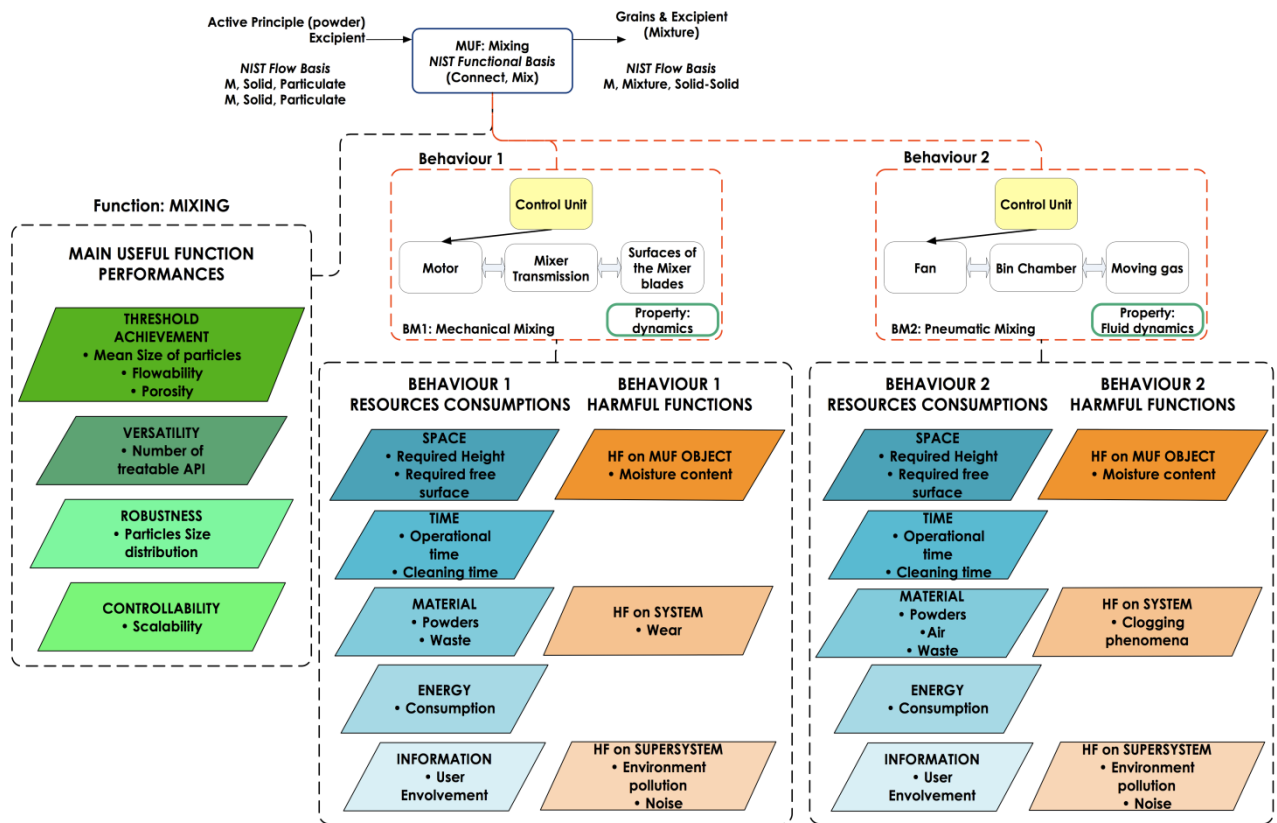

Fig. 9. Exemplary EP extraction and classification for two different Behavioral Models associated to the same elementary function.

Below, two different BMs are shown, related to mechanical and pneumatic mixing respectively. Each BM is characterized by a specific set of resources and harmful functions EPs. Similarly, each BM has a number of relevant CPs, classified according to the categories described in section 4.2.

5.2 Contradiction analysis

Once that EPs and CPs related to each BM have been identified, it is possible to analyze and count the related contradictions, as described in section 4.3.

Table 1 summarizes the overall number of EPs, CPs and resulting contradictions identified for each BM. The analysis has been further detailed, by classifying the contradictions into 6 subsets, according to the criteria described in section 4.4, thus distinguishing between contradictions characterized by EPs of different types (P vs. P, P vs. R, P vs. HF etc).

BM	EPs	CPs	Contrad. count	Maturity Level
BA1	19	43	1127	G
BC1	22	16	633	E
BD1	20	16	553	E
BE1	19	23	445	G
BE2	19	22	456	D
BF1	19	18	319	D
BF2	21	18	537	G
BF3	18	14	274	E
BM1	18	29	464	D
BM2	19	29	518	G
BM3	20	19	521	G
BS1	21	11	239	D
BS2	21	26	869	E
BS3	21	21	566	E

Table 1. EPs, CPs, and contradictions identified for each BM and their maturity level estimated by the subject meta-experts: emerging (E); growing (G); declining (D).

Moreover, the maturity level of each BM has been assessed on the basis of a joined evaluation of the subject meta-experts: each technology has been

evaluated as “emerging”, “growing” or “declining” (table 1, right), in accordance with the traditional evolutionary stages depicted in fig. 2.

Such a classification allows to perform correlation analyses between the nature of the contradictions and the maturity level of a given technology, in order to check the existence of characteristic features (Table 2).

With the aim of identifying distribution peculiarities, it has been decided to focus the analysis only on the types of contradictions characterized by a higher non-uniformity, i.e. characterized by a bigger standard-deviation / average ratio (Table 2, below). Therefore, the contradictions involving mixed-types EPs, i.e. P vs. R, P vs. HF, R vs. HF, are assumed as not relevant for maturity assessment. The remaining contradictions types show a reducing number of P vs P contradictions, as well as an increase of conflicts between consumed resources R vs R (Table 3).

	P vs P	P vs R	P vs HF	HF vs HF	HF vs R	R vs R
BA1	5,5%	39,8%	16,8%	3,9%	18,7%	15,4%
BC1	13,6%	37,3%	24,2%	2,1%	12,0%	10,9%
BD1	8,0%	44,5%	24,6%	4,5%	11,6%	6,9%
BE1	2,5%	45,8%	15,7%	3,4%	18,0%	14,6%
BE2	2,4%	27,9%	14,9%	7,7%	27,2%	20,0%
BF1	5,6%	42,6%	13,8%	0,9%	10,7%	26,3%
BF2	3,7%	34,6%	26,8%	5,6%	18,2%	11,0%
BF3	15,0%	44,2%	22,3%	0,4%	8,0%	10,2%
BM1	2,2%	42,7%	14,9%	0,4%	11,4%	28,4%
BM2	3,5%	38,8%	13,9%	4,2%	21,2%	18,3%
BM3	1,5%	43,4%	26,3%	1,3%	11,7%	15,7%
BS1	0,0%	26,8%	30,1%	5,0%	22,6%	15,5%
BS2	7,6%	30,5%	25,4%	7,2%	18,4%	10,8%
BS3	5,8%	41,0%	21,4%	6,2%	16,3%	9,4%
MAX	15,0%	45,8%	30,1%	7,7%	27,2%	28,4%
AVG	5,5%	38,6%	20,8%	3,8%	16,1%	15,2%
MIN	0,0%	26,8%	13,8%	0,4%	8,0%	6,9%
StdDev	4,4%	6,3%	5,6%	2,5%	5,4%	6,3%
StdDev/Avg	79,7%	16,4%	27,1%	65,1%	33,7%	41,3%

Table 2. Distribution of contradictions among the BMs.

Technology profile	Performance vs. Performance	Harmful functions vs. Harmful functions	Resources vs. Resources
Emerging	41,6%	17,9%	40,5%
Growing	14,8%	16,7%	68,5%
Declining	8,4%	17,6%	74,0%

Table 3. Average percentage of contradictions for BMs associated to the same stage of evolution.

More detailed information can be extracted by analyzing the 78 sub-classes of contradictions defined in section 4.4, even if it is worth to perform the analysis by taking into account a wider range of technologies, in order to have a suitable statistical sample.

6 CONCLUSIONS

The present paper has introduced a systematic approach for correlating the stage of evolution of a technical system and the contradictions characterizing its behaviour, with the aim of building a reliable index for maturity assessment. The proposed approach has been applied to the tablets manufacturing technologies in the pharmaceutical sector.

The promising results obtained so far suggest to extend the analysis to a higher number of case studies in order to check if the identified correlations can be assumed as invariant with respect to the field of applications.

It is worth to mention that the maturity level of a specific BM measures the evolutionary stage of a technology with respect to its way to deliver a certain elementary function. Nevertheless, each technology must be evaluated by taking into account the overall process, thus the whole sequence of elementary functions characterizing its process. This means that a technology overall classified as mature, can involve elementary actions accomplished with specific solutions still capable of further evolution and vice versa, emerging technologies sometimes include obsolete sub-steps. The correlation analysis proposed in this paper allows highlighting these non-uniformities, which can be leveraged to foster the development of innovative solutions and the hybridization of alternative technologies.

ACKNOWLEDGMENTS

The authors would like to thank Alessandro Cardillo from Politecnico di Milano and Yuri Borgianni from Università di Firenze for their contribution to the present research.

LIST OF ACRONYMS

AF: Auxiliary Function
 BM: Behavioral Model
 CP: Control Parameter
 EMS: Energy-Material-Signal
 EP: Evaluation Parameter
 FBS: Function-Behavior-Structure
 LESE: Laws of Engineering System Evolution
 MTS: Minimal Technical System
 MUF: Main useful Function
 NET: Network of Evolutionary Trends
 TA: Technology Assessment
 TS: Technical System

REFERENCES

[1] Cascini, G., Rotini, F., Russo D.: "Networks of trends: systematic development of system evolution scenarios", Proceedings of the 8th ETRIA TRIZ Future Conference, Twente, The Netherlands, 5-7

November 2008, ISBN 978-90-365-2749-1, pp. 31-40.

- [2] Cascini, G., Rotini, F., Russo D.: "Functional modeling for TRIZ-based evolutionary analyses", Proceedings of the International Conference on Engineering Design, ICED'09, Stanford University, Stanford CA, USA, 24-27 August 2009.
- [3] Cavallucci D., Rousselot F.: "Evolution Hypothesis as a means for linking system parameters and laws of engineering system evolution". Proceedings of the 7th ETRIA TRIZ Future Conference, Frankfurt, Germany, 6-8 November 2007, ISBN 978-3-89958-340-3 Kassel University Press, pp. 31-40.
- [4] Kucharavy D., De Guio R.: "Technological forecasting and assessment of barriers for emerging technologies". Proceedings of the International Association for Management of Technology (IAMOT), 6-10 April 2008, 20 p.
- [5] Altshuler, G.S.: "Creativity as an Exact Science: The Theory of the Solution of Inventive Problems". Gordon and Breach Science Publishers, ISBN 0-677-21230-5, 1984 (original publication in Russian - 1979).
- [6] Mann D.: "Using S-Curves and Trends of Evolution in R&D Strategy Planning", the TRIZ Journal, July, 1999.
- [7] Gibson N., Slocum M.S., Clapp T.G.: "The Determination of the Technological Maturity of Ultrasonic Welding", the TRIZ Journal, July, 1999.
- [8] Gahide S., Clapp T.G., Slocum M.S.: "Application of TRIZ to Technology Forecasting - Case Study: Yarn Spinning Technology", the TRIZ Journal, July, 2000.
- [9] Cascini G., Russo D.: "Computer-Aided analysis of patents and search for TRIZ contradictions". International Journal of Product Development, Special Issue: Creativity and Innovation Employing TRIZ, Vol. 4, Nos. 1/2, 2007, pp. 52-67.
- [10] Wood F.B.: "Lessons in technology assessment". Technological Forecasting and Social Change, v. 54, 1997, pp. 145-162.
- [11] Azzone G., Manzini R.: "Quick and dirty technology assessment: The case of an Italian Research Centre". Technological Forecasting and Social Change, v. 75(8), October 2008, pp. 1324-1338.
- [12] Salamatov, Y.P. "System of The Laws of Technical Systems Evolution". Chance to adventure. Karelia Publishing House, Petrozavodsk, 1991, pp. 7-174 (in Russian).
- [13] Gero, J.S. and Rosenman, M.A.: "A conceptual framework for knowledge based design research at Sydney University's Design Computing Unit". Artificial Intelligence in Engineering, v.5(2), 1990, pp. 65-77.
- [14] Pahl, G., Beitz, W.: "Engineering Design. A Systematic Approach". 2nd edition, Springer, ISBN:3540199179, 544 pp., 1996.
- [15] Hirtz, J., Stone, R. B., McAdams, D. A., Szykman, S. and Wood, K. L.: "A Functional Basis for Engineering Design: Reconciling and Evolving Previous Efforts". NIST (National Institute of Standards and Technology) Technical Note 1447, February 2002.
- [16] Khomenko, N., De Guio, R., Lelait, L. and I. Kaikov: "A Framework for OTSM-TRIZ Based Computer Support to be used in Complex Problem Management". International Journal of Computer Application in Technology (IJCAT). Volume 30 issue 1/2, 2007.