



UNIVERSITÀ  
DEGLI STUDI  
FIRENZE

# FLORE

## Repository istituzionale dell'Università degli Studi di Firenze

### **(Non-Linear) Acoustic Landmine Detection Study**

Questa è la Versione finale referata (Post print/Accepted manuscript) della seguente pubblicazione:

*Original Citation:*

(Non-Linear) Acoustic Landmine Detection Study / F. Bellan; A. Bulletti; L. Capineri; C. Bruschini. -  
ELETTRONICO. - (2004), pp. 1-37.

*Availability:*

This version is available at: 2158/647544 since:

*Terms of use:*

Open Access

La pubblicazione è resa disponibile sotto le norme e i termini della licenza di deposito, secondo quanto stabilito dalla Policy per l'accesso aperto dell'Università degli Studi di Firenze (<https://www.sba.unifi.it/upload/policy-oa-2016-1.pdf>)

*Publisher copyright claim:*

(Article begins on next page)



# EUDEM2

**The EU in Humanitarian Demining-  
State of the Art on HD Technologies,  
Products, Services and Practices in  
Europe**

IST-2000-29220

## EUDEM2 Technology Survey

### (Non-Linear) Acoustic Landmine Detection Study

F. Bellan, A. Bulletti, L. Capineri

Ultrasound and Non Destructive Testing Laboratory

Dept. of Electronic and Telecommunications, University of Florence, Italy

C. Bruschini

EPFL-LAP, Lausanne, Switzerland

Nov. 2004

<http://www.eudem.info/>



Project funded by the European Community and  
OFES (Swiss Federal Office for Education and  
Science) under the "Information Society  
Technologies" Programme (1998-2002)

Vrije Universiteit Brussel  
VUB, B

Swiss Federal Institute of  
Technology – Lausanne  
EPFL, CH

Gdansk University of  
Technology  
GUT, PL

## Executive Summary

This report presents a review of the literature on studies, modelling and experimental applications of acoustic methods applied for the detection of buried landmines.

The report describes the state of the art of linear and non-linear acoustic methods addressing the complex phenomenon of mine response and resonance. This depends on the interaction between a mine and the soil and their relative physical properties. Models for the description of these phenomena are included and their use for the interpretation of the acquired signals is also commented on.

Experiments for evaluating these techniques are reported from recently published works and include methods which used either contact (seismic) or non-contact (acoustic) methods for excitation. For resonance detection, experimental set-ups implementing different soil vibration measurement techniques (Laser/Ultrasonic/Radar Doppler Vibrometer, acoustic impedance measurements) are included.

A *Summary Table* with structured information has been produced and processed for an update of the EUDEM2 Website ([www.eudem.info](http://www.eudem.info)).

In the Conclusions we identify some advantages and disadvantages of the use of these techniques in mined areas and sketch a 'technology readiness level' evaluation for the most relevant and tested techniques.

Finally, a proposal for the second (experimental) phase of this *Study* is made, based on experiments which have been described in the literature and also on new signal processing methods.

## Content

<b>INTRODUCTION</b>	<b>5</b>
<b>1. LINEAR AND NON-LINEAR ACOUSTIC TECHNIQUES: BASIC PRINCIPLES AND MODELS</b>	<b>5</b>
1.1 Linear Techniques	8
1.2 Non-linear Techniques	11
1.3 Summary Table	14
<b>2. METHODS, EQUIPMENT AND OPERATING CONDITIONS</b>	<b>16</b>
2.1 Transmitting Systems	16
2.1.1 Acoustic Transmitters with Loudspeakers	16
2.1.2 Electrodynamic Shakers	16
2.2 Receiving Systems	17
2.2.1 Geophones and Accelerometers	17
2.2.2 Laser Doppler Vibrometer (LDV)	18
2.2.3 Radar Doppler Vibrometer (RDV)	21
2.2.4 Ultrasonic Doppler Vibrometer (UDV)	22
2.2.5 Acoustic Microphones	24
<b>3. METHODS AND EXPERIMENTAL SET-UP FOR AN ACOUSTIC LANDMINE DETECTION SYSTEM</b>	<b>26</b>
3.1 Proposal for an Experimental Activity	26
3.2 Experiment Organization	27
<b>4. CONCLUSIONS</b>	<b>29</b>
<b>5. REFERENCES</b>	<b>31</b>
<b>6. APPENDIX A: FIELD TESTS</b>	<b>34</b>
<b>7. APPENDIX B: ACOUSTIC SENSORS</b>	<b>35</b>
<b>8. APPENDIX C: COMPANIES AND RESEARCH INSTITUTIONS LIST</b>	<b>37</b>

## Taxonomy

The following picture illustrates the techniques already used in seismo-acoustic landmine detection systems.

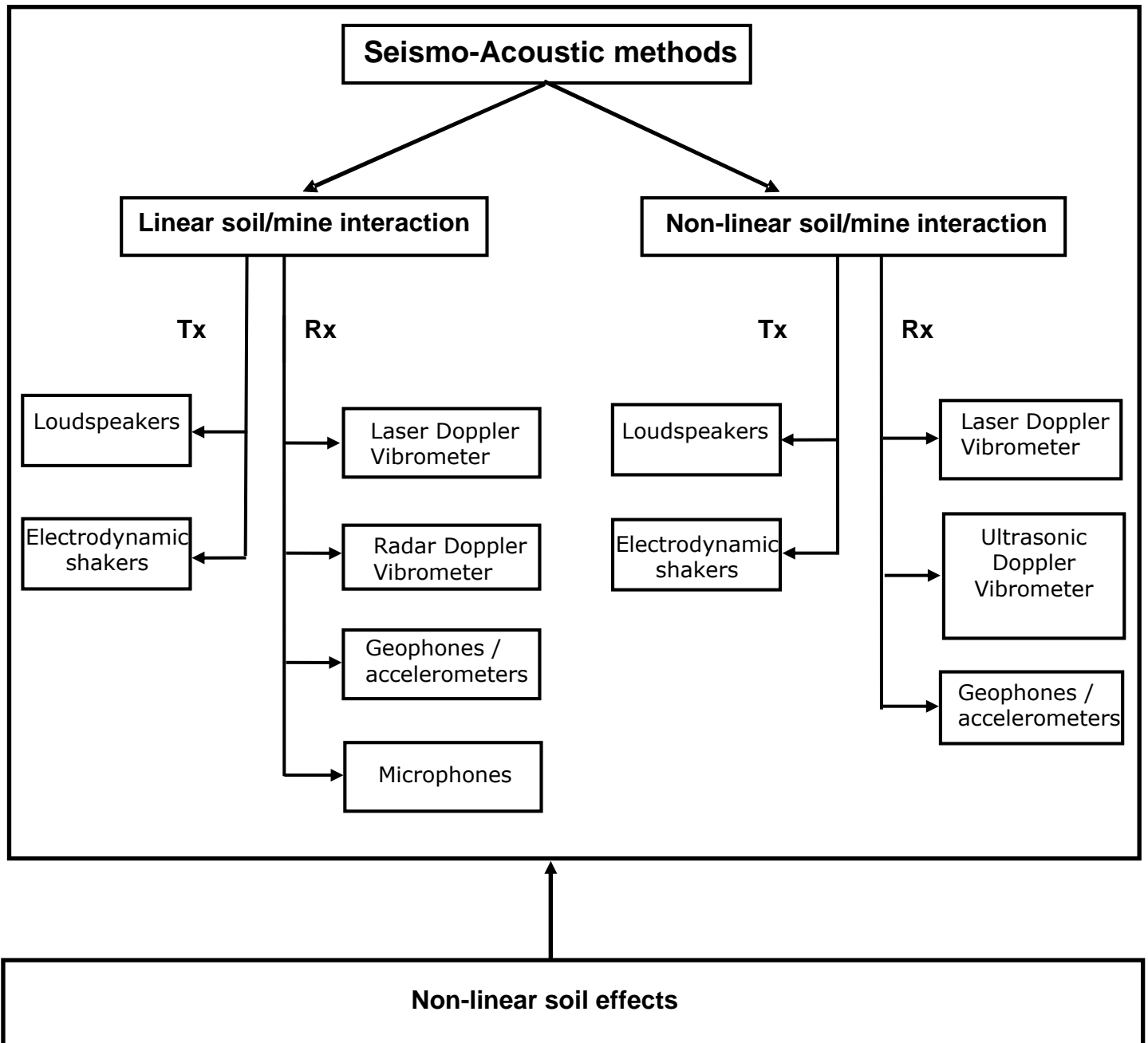

## Introduction

The overall goal of this *Study* is to identify the advantages and disadvantages (key obstacles and limits) of (non-linear) acoustic techniques applied to the landmine detection problem. In this work the collection of information available from previous studies and reports has been carried out and structured information has been produced to update the EUDEM2 Website.

Interest in this type of technique is recent and most studies and information about prototypes have been published during the last five years. The acoustic generation of seismic waves is the leading idea for new non-contact landmine detection apparatus; the effects of the interaction between the seismic waves travelling through the soil and a buried mine have been studied. The observable effect is a characteristic vibration of the mine due to its mechanical properties (particularly its compliance<sup>1</sup>) when excited by a seismic wave. The idea that objects "sound" in different ways has been historically exploited in many non-destructive testing techniques. The vibration of landmines or the resulting induced vibration of the soil surface have been measured by various techniques, both contact and non-contact. In some studies the results of these measurements with landmine surrogates have also been compared with theoretical models.

This document introduces and compares different methodologies and technological approaches, with the aim of helping to devise the new experiments and field tests which are necessary to validate this demining method. A comparison with other well known methods proposed and applied to humanitarian demining (metal detectors, ground penetrating radars, infrared, etc) with dedicated experiments has been started by some groups, but more work is still needed especially in the design of portable detection apparatus.

## 1. Linear and Non-linear Acoustic Techniques: Basic Principles and Models

Acousto-seismic methods are intended for detection of mines by vibrating them with acoustic or seismic waves that are generated and received by non-contact (acoustic) and contact (seismic) transducers, respectively. These detection methods are based on the mechanical properties (specifically, the compliance) that can differentiate the acoustic response of mines from other (usually non-compliant) objects buried in the ground. These methods have been recently applied to humanitarian demining [R1] and they are alternative/complementary to other well established methods such as metal detectors and ground penetrating radars.

When an acoustic source, say a loudspeaker, is used to transmit acoustic energy into the ground, it is necessary to consider the main physical effect of the reflection and transmission of acoustic plane waves at the air-soil interface (see Fig. 1).

---

<sup>1</sup> *Compliance*: the displacement of a linear mechanical system under unit applied force.

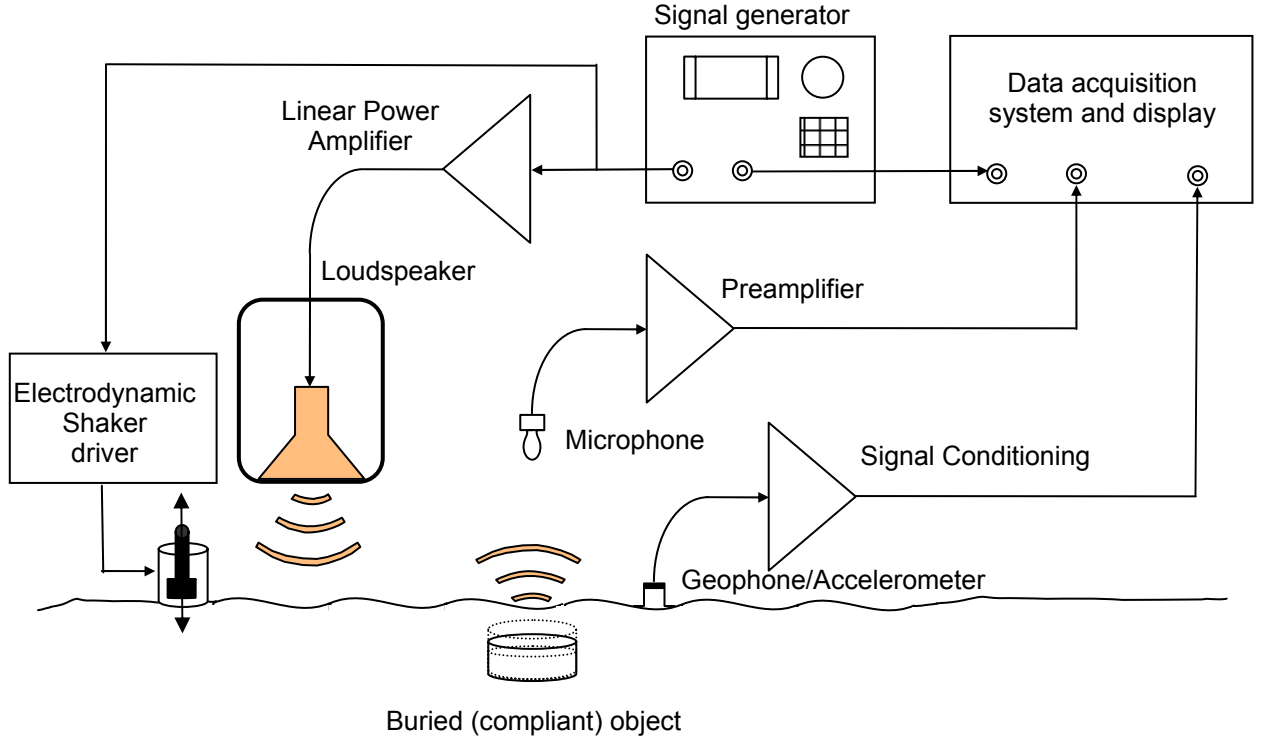

Figure 1 Diagram of the main components used in acoustic/seismic detection techniques of buried objects. Sources: Loudspeakers or seismic wave generators (e.g. electrodynamic shakers). Receivers: microphones or geophones/accelerometers.

In the case of plane wave excitation, the reflection ( $r$ ) and transmission ( $t$ ) coefficients are defined by:

$$r = \frac{\rho_2 v_2 \cos(\theta_i) - \rho_1 \sqrt{v_1^2 - v_2^2 \sin^2(\theta_i)}}{\rho_2 v_2 \cos(\theta_i) + \rho_1 \sqrt{v_1^2 - v_2^2 \sin^2(\theta_i)}}, \quad t = 1 + r \quad (1)$$

where:  $\theta_i$  incident angle,  $\theta_t$  transmission angle,  $\rho_1$  mass density and  $v_1$  propagation velocity in medium 1,  $\rho_2$  mass density and  $v_2$  propagation velocity in medium 2.

According to physical optics, the relationship between the incident angle  $\theta_i$  and refracted angle  $\theta_t$ , is dictated by Snell's law (see Fig. 2):

$$\frac{\sin(\theta_i)}{\sin(\theta_t)} = \frac{v_i}{v_t} \quad (2)$$

For example, considering an acoustic source in air and an object buried in an average sandy soil, we have  $\rho_1 = 1.293 \text{ kg/m}^3$ ,  $v_1 = 331 \text{ m/s}$  (at room temperature),  $\rho_2 = 1220 \text{ kg/m}^3$  and  $v_2 = 100 \text{ m/s}$ .

Assuming a perpendicular incidence to the soil ( $\theta_i = 0$ ) and substituting these values in Eq. 1, we obtain:

$$r = \frac{\rho_2 v_2 - \rho_1 v_1}{\rho_2 v_2 + \rho_1 v_1} = \frac{Z_2 - Z_1}{Z_2 + Z_1} = \frac{1.22 \cdot 10^5 - 428}{1.22 \cdot 10^5 + 428} = 0.993$$

where  $Z_i = \rho_i v_i$  is the acoustic impedance of medium  $i$ .

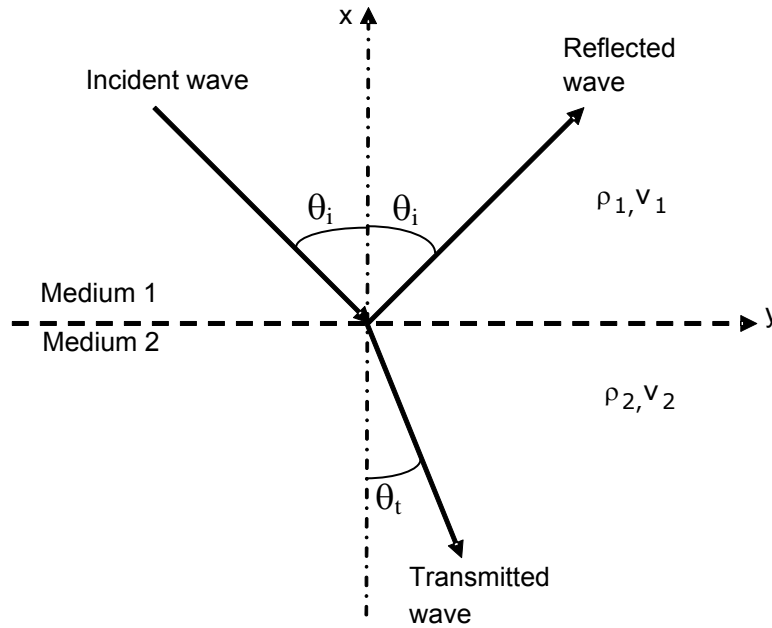

Figure 2 Reflection and refraction of a plane wave at the boundary of two homogeneous semi-infinite media.

The reflection and transmission coefficients ( $R$  and  $T$  respectively) for the acoustic intensity are:

$$R = r^2$$

$$T = 1-R = 1-r^2 = 1-0.993^2 = 0.013$$

From this simple example we find that only 1.3% of the generated acoustic power is transmitted into the soil, and so in general this method is less efficient than seismic sources (such as electrodynamic shakers [R9]) in contact with the soil.

The airborne source has however the advantage of not being in contact with the soil, and is thus intrinsically safer for humanitarian demining operations than contact sources that generate seismic waves in the soil. In the latter case the seismic waves travel on the surface of the soil and interact with the buried objects. According to preliminary tests carried out by Donskoy *et al.*, it has been confirmed that seismic excitation is more efficient for compact and dense soils, while airborne acoustic sources are more suitable for less compact soils. The interactions with the target object give rise to different propagation mechanisms that are governed by reflection/refraction (wavelength much smaller than the object characteristic size) or diffraction (wavelength comparable to object characteristic size). The choice of the operating frequencies is crucial because they represent a compromise between the media attenuation, the characteristic response of the mine, and the sensitivity of the generation/detection system. The frequency  $f$  determines the wavelength  $\lambda_i = v_i/f$ , where  $v_i$  is the velocity of the probing wave in a specified medium ( $i=1,2$ ).

Typically in the acousto-seismic approach low frequency waves, usually in the range 60-1000 Hz, are used to generate compressional waves that can propagate at high speed into the soil and can vibrate a buried mine; this vibration is measured on the soil surface above the mine using remote acoustic sensors (e.g. microphones) or contact sensors (e.g. geophones/accelerometers).

The limitation for the detection depth of acoustic/seismic techniques is estimated experimentally to be about 150 mm for antipersonnel mines (see *Summary Table*, section 1.3). Up to this distance the effect of soil attenuation is negligible. Also, the attenuation of the acoustic waves in air becomes negligible for this frequency range and for travel distances of less than one metre (the absorption coefficient in air is 0.54 dB/100m at 1 kHz,  $T=20^\circ\text{C}$  and  $\text{RH}=70\%$ ).



Widely used remote sensors are vibrometers based on radar [R9], laser [R11] or ultrasonic [R17] techniques. Despite their very high sensitivity (laser vibrometers can detect displacements of the soil surface of a fraction of the wavelength of visible light, with a resolution possibly better than 100 nm), their use in the field could be cumbersome, and other more technically feasible solutions need to be developed.

The basic physical relationships described above are valid under the assumption of homogeneous and isotropic characteristics of the transmission media 1 and 2; however, in real applications these assumptions are not strictly valid. Soil can have extremely variable acoustic characteristics depending on its nature (sand, gravel, loam, etc) and the behaviour can be linear or non-linear depending on the intensity and the frequency of the probing acoustic wave, according to the Biot theory [R7].

### 1.1. Linear Techniques

A simple model that explains the mechanical resonance behaviour of a compliant buried mine is the well-known mass-spring mechanical oscillator, which has a resonance response which depends on the mass of the soil on top of the mine and the compliance of the mine casing. Therefore, a specific frequency for the vibrating signature of the mine can be found and this depends on the mine, soil, and excitation characteristics. The acoustic response can be used for the detection and discrimination of a buried landmine. Neglecting non-linear effects, the entire mechanical system can be modelled as shown in Fig. 3.

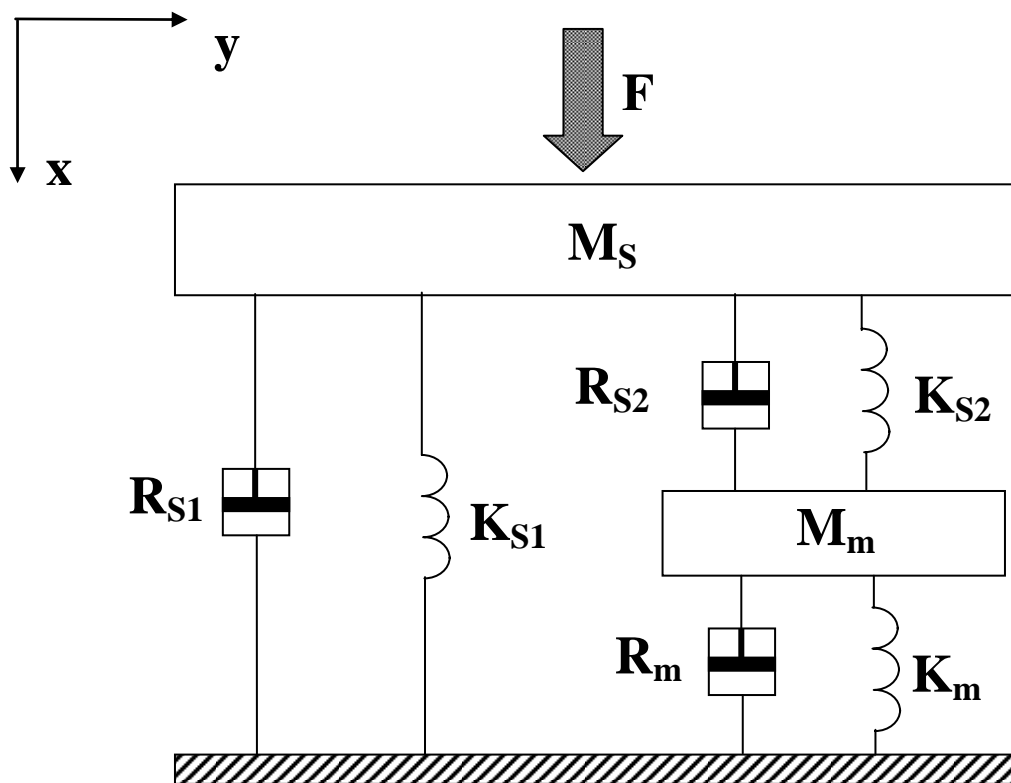

Figure 3 Equivalent linear mechanical model of an oscillator representing the mine-soil system.

In Fig. 3  $M_s$  is the mass of the column of soil above the vibrating mine;  $M_m$  is the mass of the mine;  $R_m$  is the damping coefficient of the mine;  $K_m$  is the static stiffness of the mine;  $K_{s1}$  and  $K_{s2}$  are the shear and the compression stiffness of soil;  $R_{s1}$  and  $R_{s2}$  are the soil damping coefficients due to shear and compression of the soil respectively, and  $F$  is the external force applied to the soil surface. The force  $F$  is also related to the external pressure  $P$  applied at the surface. By using this model the resonance frequencies of the oscillator can be investigated. An important dynamic parameter in the selection of a frequency range for mine detection is the acoustic impedance  $Z_m$

(or equivalently the acoustic admittance,  $Y_m$ ) of the mine, which it is defined by the ratio of applied variable pressure  $p$  and the corresponding velocity of vibration  $v$ :

$$Z_m = \frac{1}{Y_m} = \frac{p}{v} \quad (3)$$

$Z_m$ : acoustic impedance [(Pa\*s)/m]

$p$ : dynamic pressure [Pa]

$v$ : velocity [m/s]

According to Eq. 3, acoustic impedance measurements are fundamental in determining the characteristic parameters of the elastic behaviour of mines, and this equation indicates that both pressure and velocity sensors are required. When  $p$  and  $v$  are recorded on the soil surface just above the mine it is appropriate to speak of the acoustic impedance of the mine-soil system. The literature ([R2], [R3]) reports experimental measurements of  $Z_m$  which were made by applying an external excitation (dynamic force  $F$ ) to the mine-soil system; the dynamic parameters per unit area (dynamic stiffness,  $k_m$ ; dynamic mass,  $m_m$  and the damping coefficient,  $r_m$ ) of this model were then estimated by fitting procedures.

*Note that capital letters have been used for static parameters and lower case letters for dynamic parameters.*

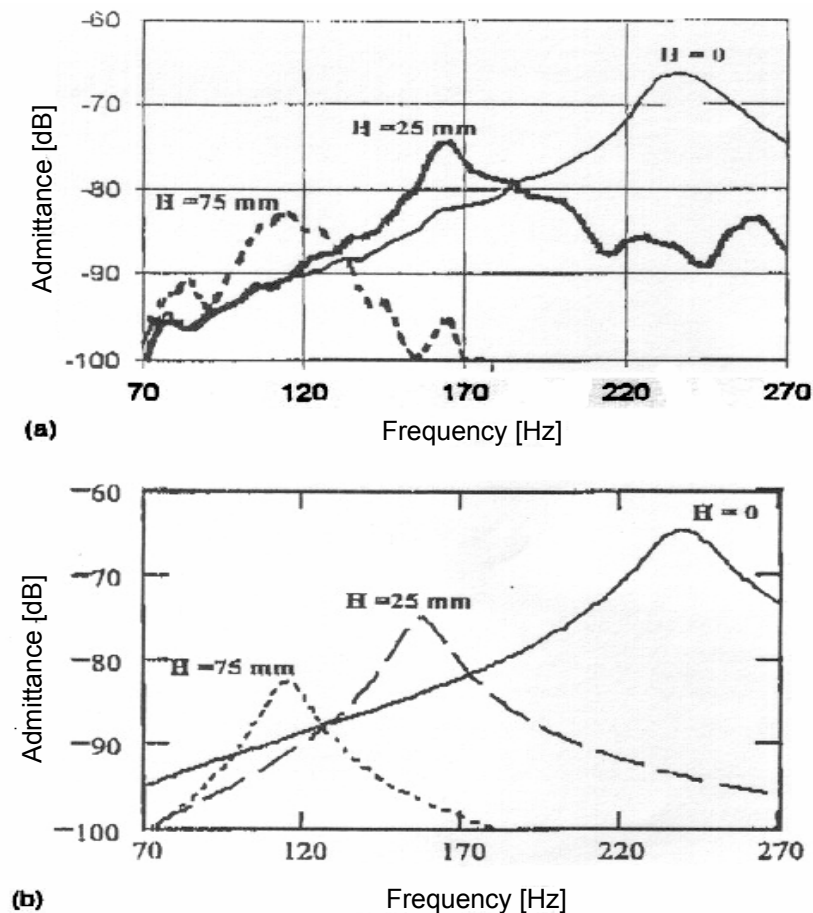

Figure 4 Admittance dependence from depth ( $H$ ) of a buried mine; (a) field data for the antitank mine VS 1.6; (b) calculated data from the model for the same mine [R3].

Fig. 4 shows the good agreement between experimental and calculated data, which confirms the validity of the model. The figure also shows another aspect: the resonance frequency is dependent on the depth of the buried mine. All results presented in this section are valid only under the linear model assumption. Fig. 4 shows also that the "vibrating signature" of a buried mine is in fact due to simultaneous linear and non-linear effects, specifically the amplitude attenuation is due to linear effects, and the frequency shift of the resonance response is due to the non-linear effects.

In [R3] a simplified model for determining the frequency response at resonance of AT (antitank) and AP (antipersonnel) mines has also been developed; Table 1 shows the good agreement (within 5%) between predicted and measured data. To give an idea of the basic concept underlying acoustic detection, in the last two rows of Table 1 it can be seen that the order of magnitude of the stiffness for both soil and rigid targets is well above that of plastic mines. The good stiffness contrast leads also to a good discrimination capability by the seismo-acoustic techniques when the measurements are taken around the (mine's) resonance frequency.

Mine type	Description	Dynamic Stiffness $k_m \times 10^7$ [Pa/m]	Dynamic Mass $m_m$ [kg/m <sup>2</sup> ]	Damping Coefficient $r_m$ [kg/(sm <sup>2</sup> )]	Experimental Resonance Frequency [Hz]	Simulated Resonance Frequency [Hz]
TS-50	AP Plastic	10	9	4000	520	510
VS-50	AP Plastic	6	13	3300	330	340
VS-1.6	AT Plastic	2.5	12	1700	220	220
TMA-5	AT Plastic	0.2	1.4	300	190	184
SH-55	AT Plastic	2.5	8	3000	280	270
VS-HCT-2	AT Plastic	2.8	3.3	500	465	460
TM-46	AT Metal	4	16	1200	250	250
TMA-4	AT Plastic	17	65	20000	250	257
AT-72	AT Plastic	2	14	1800	200	190
Soil	----	100	----	----	----	----
Concrete or Rigid target	----	>100	----	----	----	----

Table 1. Dynamic parameters ( $m_m$ ,  $r_m$ ,  $k_m$ ) per unit area of real mines, and comparison between experimental and simulated resonance frequencies [R3].

## 1.2. Non-linear Techniques

The non-linear mechanism, proposed and studied by Donskoy [R1],[R3],[R4],[R5], involves a one dimensional model where the top mine–soil planar interface separates two elastic surfaces.

During the compressive phase of the soil–mine system, the mine's top surface and the soil surface immediately above it remain in contact, whereas these two surfaces separate during the tensile phase, due to a relatively high compliance of the mine. It is this “bouncing” soil–mine interface which is thought to act as a non-linear oscillator. These phenomena are very interesting for landmine detection systems because it is possible to identify non-metallic mines, such as plastic mines, by generating mine-soil system signatures in the spectrum of the vibrations measured at the soil-air interface. It has been demonstrated that this signature depends mainly on the shape and compliance of the mine and is independent of the material of the mine casing. Another advantage about this technique is the possibility it offers for reducing the false alarm rate. Donskoy *et al.* pointed out that if a buried object such as roots, pieces of metal or bricks, has no difference from soil in its relative compliance properties, then it would not be indicated as a false alarm since the non-linear mechanism would vanish.

Non-linear effects, due to compliance of buried objects such as antitank and antipersonnel mines, can be detected by using a double frequency excitation from two sources operating at  $f_1$  and  $f_2$ ; in this way the compliant mine can be detected by the intermodulation of these two waves and the subsequent generation of sum and difference frequencies. This technique has been demonstrated by experiments to be more sensitive than the linear method [R6].

The soil vibration amplitude due to on non-linear effects is determined by the type of soil and the external pressure level. Once the non-linear effect is exhibited, its contribution to the detected signal amplitude can be comparable or even greater than the linear one.

For the determination of the sound power level  $L_w$  we can use the following relationship:

$$L_w = 10 \text{ Log } \frac{P}{P_0} \text{ dB} \quad (4)$$

where  $P$  is the RMS value of sound power in Watts and  $P_0 = 1 \text{ pW}$ , while the sound pressure level  $L_p$  can be predicted from  $L_w$  in free-field with the following relationship:

$$L_p = L_w + \text{Log}(Q) - 20 \text{ Log}(d) - 10.8 \text{ dB} \quad (5)$$

where  $d$  is the distance in metres and  $Q$  is the directivity factor of the acoustic source.

A simple model of the non-linear oscillator system is shown in Fig. 5. The applied force ( $F$ ) vs. displacement ( $x$ ) is shown in Fig. 5a for the compressive and tensile phases of the mine-soil system, while in Fig. 5b the equivalent mechanical models valid during these two phases are shown. It can be seen that the springs are linked together during the compressive phase and separated during the tensile phase.

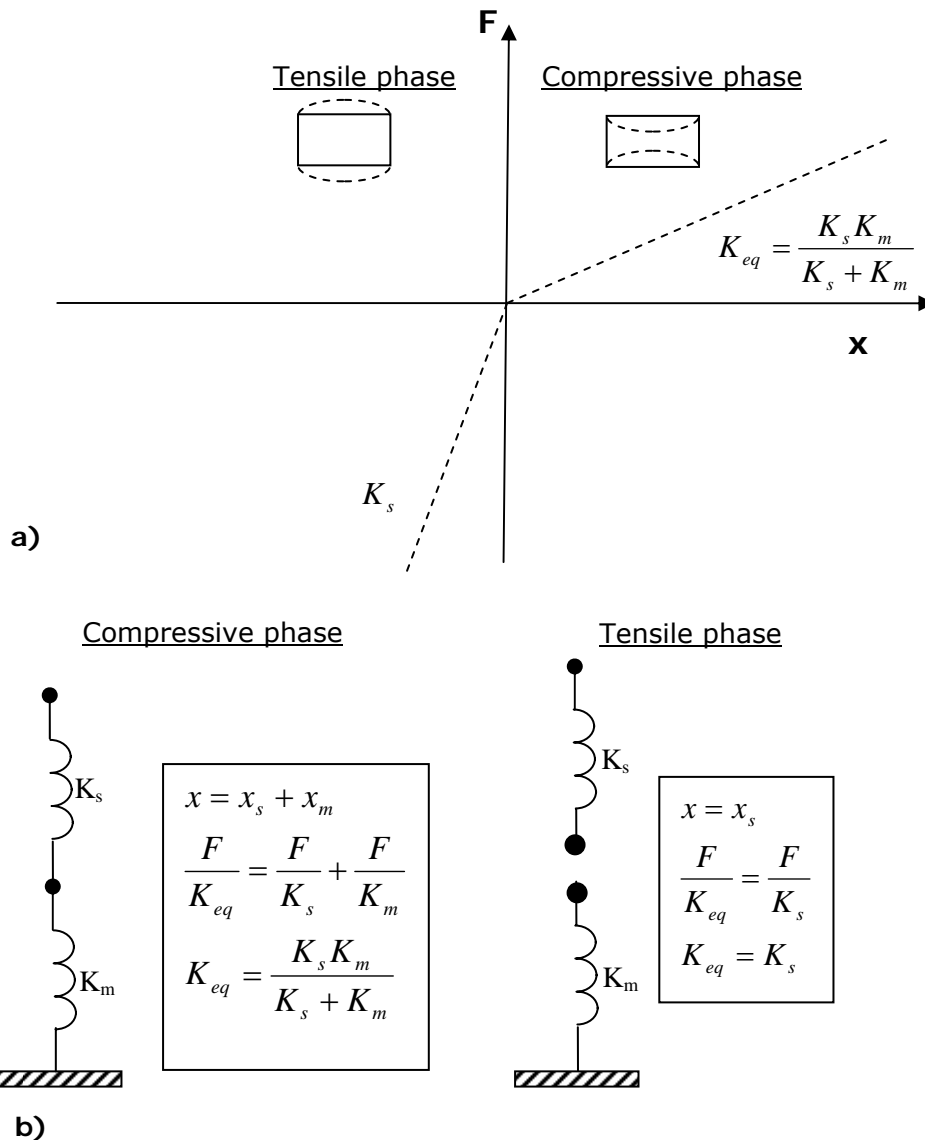

Figure 5 Mechanical models of the non-linear effects in the mine-soil system during the compressive and tensile phases: a) Force (F) vs. displacement (x). b) Equivalent stiffness  $K_{eq}$  of the mine-soil system expressed in terms of the mine and soil stiffness  $K_m$  and  $K_s$  respectively.

Refinements to this model are the object of current research activities and recent developments can be found in [R6] and [R33].

An attempt to apply non-linear techniques to the detection of unexploded ordnance (UXO) has been carried out, but the weak interaction between UXO and soil led to poor results due the negligible compliance of the UXO [R1],[R3],[R5],[R6].

In addition to the previously explained non-linear effects of the mine-soil system, the non-linear behaviour of porous soils [R4] introduces a dependence of the displacement resonance frequency on the sound pressure level (Fig.7). Furthermore, it can be seen that at higher pressure the resonant peak moves to lower frequencies and correspondingly the bandwidth decreases. In general, the superposition of these two non-linear effects makes the interpretation of the real vibrating signature more difficult than in the case of the simpler mine-soil system.

Fig. 6 shows a comparison between linear and non-linear responses of a mine as described in [R6].

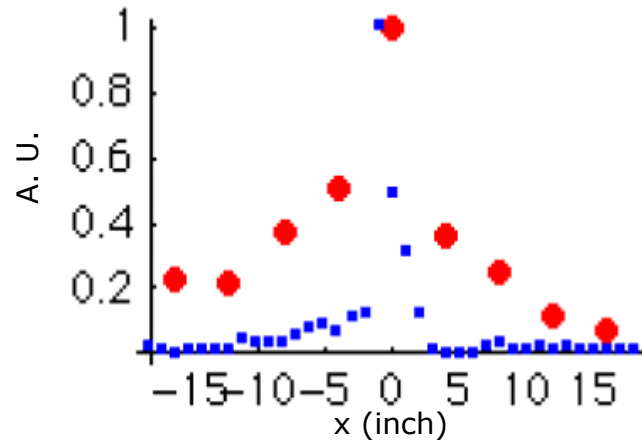

Figure 6 Comparison of non-linear detection profile (square points) and linear detection profile (large dots), where  $x$  is the distance of the detector from the centre of the mine [R6].

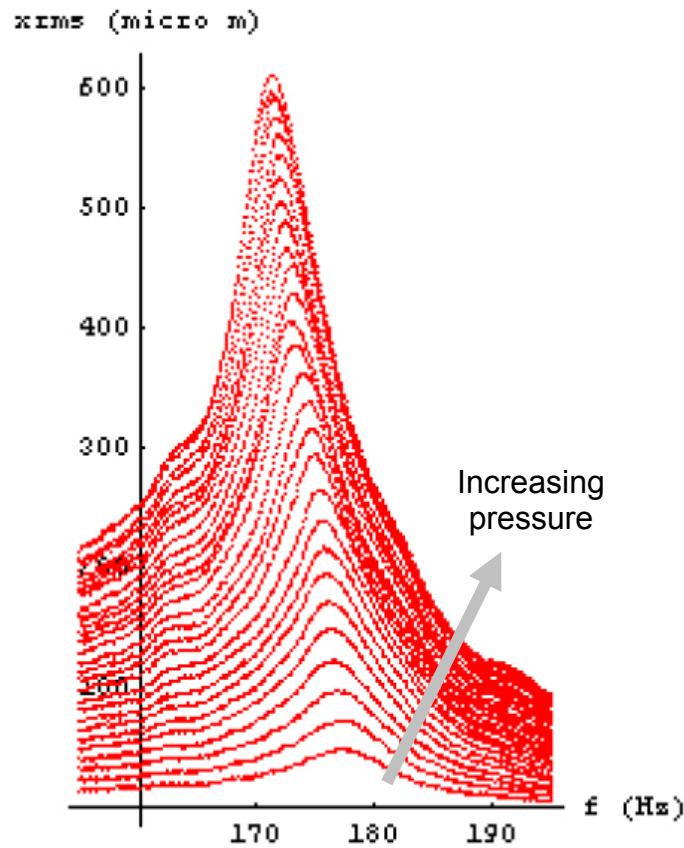

Figure 7 Non-linear mechanical resonance curves for increased pressure amplitude drive. Vertical scale: displacement of the top plate of the soil-mass oscillator. Horizontal scale: Resonance frequency of the soil-mass oscillator [R6].

### 1.3. Summary Table

A literature search of acoustic mine detection methods has been carried out and from this the following a *Summary Table* has been produced, where different acoustic landmine detection methods are classified in two categories: *Linear Seismo-Acoustic* and *Non-linear Seismo-Acoustic*. A third technique (*Metal Detector*) is also reported for comparison, as it is currently the standard technique mostly widely used for landmine detection.

Values shown in the table, for the different techniques, are typical values reported in the literature (see *References* column).

In the *Soil* column, the different types of soil used in the tests described in the reference articles are reported.

The reported *Scanning times* are indicative. The actual *Scanning time* depends heavily on a sensor's False Alarm rate in the field, as well as on the deminers' operating procedures.

The *Tested Target* refers to experimental tests conducted in field applications or in laboratory facilities, whereas the *Unexploded Ordnance (UXO)* column refers to a theoretical evaluation on the basis of the linear and non-linear approaches reported in sections 1.1 and 1.2.

Technique	Transmitter		Receiver (1)		Scanning time [s/m <sup>2</sup> ]	Tested Target		Unexploded Ordnance (UXO)	Vegetation	Soil	Target depth [cm]	Cost (2)	Portability (3)	References	Patents	
	Contact	Non-Contact	Contact	Non-Contact		Mines										
						Antipersonnel	Antitank									
Linear Seismo-Acoustic		Loudspeaker		Microphones	N.A.	No	Yes	Yes	N.A.	Compacted loamy soil with agglomerates	5	Low	High	[R18]	[P1], [P2], [P3], [P5], [P7]	
	Electrodynamic shaker			Radar - GPR	N.A.	Yes	Yes		N.A.	Sand	N.A.	Medium	Low	[R7]		
	Electrodynamic shaker			Radar - GPR	N.A.	Yes	Yes		N.A.	Damp sand	5	High	High	[R8]		
		Loudspeaker		LDV	N.A.	No	Yes		Sensitive	Gravel road, sandy-gravel road	10	High	Low	[R11]		
		Loudspeaker		LDV	N.A.	No	Yes		Sensitive	Sandy-gravel road	10	High	Low	[R26]		
		Loudspeaker		LDV	N.A.	Yes	No		Sensitive	Homogeneous and very dry	2	High	Low	[R27]		
		Loudspeaker		LDV	180 - 1200	Yes	No		Sensitive	Sandy-gravel road	Typ. 7.5 - Max. 20	High	Low	[R14]		
	Electrodynamic shaker			Radar - GPR	32440	Yes	Yes		Sensitive	Damp compacted sand	10 - 20	High	Low	[R9]		
	Electrodynamic shaker			Radar - GPR	N.A.	Yes	Yes		Sensitive	Damp sand	5	High	Low	[R31]		
		Loudspeaker		LDV	N.A.	Yes	No		Sensitive	Air - filled porous soil	2.5 - 5	High	Low	[R29]		
		Loudspeaker		LDV	40	No	Yes		Sensitive	Sandy-gravel road	15	High	Low	[R16]		
		Loudspeaker	Geophone		600	No	Yes		N.A.	N.A.	4	Low	Medium	[R12]		
		Loudspeaker		LDV	N.A.	Yes	Yes		Sensitive	Gravel, sand and fine soil	2.5 - 5	High	Low	[R15]		
	Non-linear Seismo-Acoustic		Loudspeaker	Accelerometer		N.A.	Yes		No	No	Not sensitive	N.A.	N.A.	Low		Medium
		Loudspeaker		LDV	60	No	Yes	Sensitive	N.A.		3.7 - 7	High	Low	[R13]		
		Loudspeaker	Geophone		N.A.	No	Yes	Sensitive	Homogeneous and very dry		3.8	Low	Medium	[R6]		
		Loudspeaker		LDV	N.A.	Yes	Yes	Sensitive	Gravel and sandy soil		5 - 13	High	Low	[R3]		
		Loudspeaker		LDV	N.A.	Yes	Yes	Sensitive	Gravel and sandy soil		5 - 13	High	Low	[R5]		
Electrodynamic shaker		Loudspeaker		LDV, Microwave Sensor, UDV	150-100 (Antipersonnel) 16-45 (Antitank)	Yes	Yes	Sensitive	N.A.		N.A.	High (LDV, microwave sensor) Low (UDV)	N.A.	N.A.	[R24]	
Metal Detector			Coil		Coil	200	Yes	Yes	Yes		Not Sensitive	N.A.	15 - 20	€2000 - €4000	High	[R32]

LEGEND		
(1) GPR: Ground Penetrating Radar LDV: Laser Doppler Vibrometer UDV: Ultrasonic Doppler Vibrometer	(2) High: ≥ 20000 euro Medium: 5000 - 20000 euro Low: < 5000 euro	(3) Handheld instrument



## 2. Methods, Equipment and Operating Conditions

In the following sections, the transmitting and receiving systems referred in the *Summary Table* are described and system characteristics like cost, portability, scanning time, type of mine detection (AT or AP), target depth and environmental operating conditions are considered.

### 2.1. Transmitting Systems

There are two different types of transmitting systems which have been used: electrodynamic shakers in contact with soil delivering seismic energy, and non-contact (airborne) systems with loudspeakers delivering acoustic energy. For example, in the experiment described in [R5] both acoustic loudspeakers and electrodynamic shakers were used and compared.

#### 2.1.1. Acoustic Transmitters with Loudspeakers

Loudspeakers are non-contact excitation systems. Typically the transmitting system is made of two subwoofer loudspeakers (e.g. Peavey 118 sub 8 HC or Peavey Impulse 200 Subwoofers), to which a third sound source (e.g. the previous two and a third subwoofer Altec model 290-4G) can be added.

In [R7], [R8], [R9], [R10], the loudspeakers were decoupled from the soil (using tripods on which speakers are mounted), and they were placed at a height of 22 cm above the soil surface. The speakers were separated by 100 cm and placed 186 cm from the centre of a scanned patch containing a buried landmine. The sound pressure level in air ranged between 90 dB and 120 dB and typically linear power amplifiers with output power from 100 to 200 W were used (note that this high pressure level can induce fatigue problems to the operators in proximity of the acoustic source). The angle of sound incidence is not critical, but the acoustic coupling with the soil is inefficient because most of the energy is dissipated and backscattered in the air. The sound source radiates pseudo-random noise typically covering the frequency range between 80 Hz and 300 Hz for AT mines and between 100 Hz and 680 Hz for AP mines. The signal processing usually employs a narrow band analysis which evaluates the RMS amplitude of the signal over narrow bands (e.g. 10 Hz) covering the spectrum emitted by the noise source; for this purpose a second loudspeaker is necessary.

#### 2.1.2. Electrodynamic Shakers

The electrodynamic shaker is a contact excitation system placed next to the target area and coupled to the ground using an elongated metal foot attached to the shaker head (moving coil). The long dimension of the foot is parallel to the excited wave fronts. This was found to preferentially excite surface waves<sup>2</sup> and to direct energy towards the measurement region. These surface waves interact with a mine that is buried in the soil. The shaker is free standing so that the ground is driven against the tail mass (permanent magnet).

---

<sup>2</sup> *Surface wave*: A wave that is guided along the interface between two different media or by a refractive index gradient.

## 2.2. Receiving Systems

### 2.2.1. Geophones and Accelerometers

Since the early 1980s, the acousto-seismic coupled surface vibration has been measured using geophones, which are velocity sensors. The output voltage of a geophone is proportional to the vibration velocity on the surface to which the geophone is attached. For example, an L-10 geophone (manufactured by Mark Products Inc.) has high sensitivity over a frequency range between 50 Hz and 1 kHz and was used for these applications. Other models of geophones have different frequency ranges, e.g. 50-300 Hz. In an early study of acousto-seismic landmine detection, a geophone array of eight-by-eight geophones was deployed to measure the acousto-seismic coupling signals over a sub-patch of the ground. By displacing the array sub-patch by sub-patch, a larger area could be covered as schematically illustrated in Fig.8. In this way, a map of data could be obtained showing the location of buried landmines [R11], [R12]. Higher frequency (1-10) kHz measurements are more conveniently made using accelerometers. It should be noted that both geophones and accelerometers can measure velocity amplitude only when a sinusoidal excitation is applied to the soil.

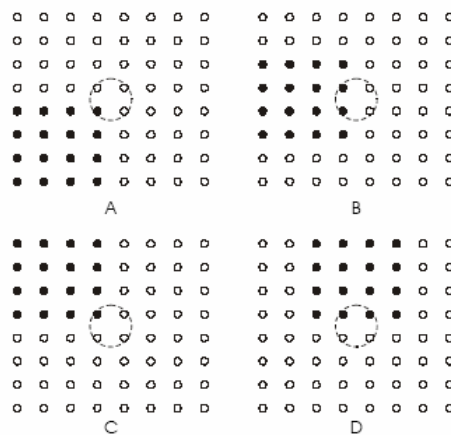

Figure 8 Geophone array (1mx1m). The four-by-four geophone array is first deployed within the overall eight-by-eight array as shown in Fig. 8A. The dark circles show the position of the geophones. The geophone array was then sequentially moved through the eight-by-eight array as shown in Fig. 8B, 8C and 8D. The dashed large circle in the centre of the eight-by-eight array is the position of the buried target [R11], [R12].

Geophones/accelerometers can be used both for linear or non-linear seismo-acoustic techniques and are usually placed in a small area above or next to the mine: for this reason the investigation time of a large area can be very high. The time to make a confirmation measurement for a target located within a 0.1 m<sup>2</sup> area could be of the order of several minutes.

Geophones/accelerometers have been used for AT mine detection (target depth up to 4 cm) but not yet for AP mines. Geophones/accelerometers should be used in good contact with the ground surface to measure the surface vibration. The quality of this coupling was found to be critical for repeatable measurements. Although geophones/accelerometers are contact sensors, they require only minimal electronics for functional operation and are low cost sensors. In humanitarian landmine detection, safe deployment of a low cost simple acousto-seismic coupling confirmation sensor using a single geophone with minimal electronics might still be a useful technology. This single geophone/accelerometer technique will, of course, be very slow if used to scan larger areas.



isolation box 2.3 m above the ground and the laser beam was focused onto the surface at an angle of 10 deg from the normal to the surface. The horn loudspeaker was suspended below the LDV platform as a sound source for the frequency range between 300 Hz and 680 Hz. The centre of the horn opening was placed at approximately 1.8 m above the ground and 0.8 m from the centre of a scanned patch. For the frequency range between 100 and 300 Hz, two subwoofers placed beside the LDV were used. The sound source radiated periodic pseudorandom noise while the laser beam was deployed to predefined grid points (one by one). In responding to the acoustic excitation, the instantaneous seismic velocity of the ground surface was sampled through one data collection channel, a Fourier transform applied, and the result averaged over several periods in the complex frequency domain. A resulting complex velocity function  $v(f)$  was obtained at each grid point.

The magnitude  $M_{ij}$  of the spectrum of the velocity function  $v(f)$ , at each grid point, was integrated over a frequency band in magnitude velocity in the presence of a mine. Thus:

$$M_{ij} \propto \int_{f_1}^{f_2} |v_{ij}(f)| df \quad (6)$$

with  $f_1, f_2$  denoting the lower and upper frequency limits of the integration, and  $(i, j)$  the index of a point corresponding to the intersection of the  $i$ th row and  $j$ th column of the raster grid.

In this way, the single-valued magnitude velocity could be presented as data points on a colour dot map. An example of colour dot map results for plastic antitank and antipersonnel mines is shown in Fig.10 [R15] utilising a linear technique.

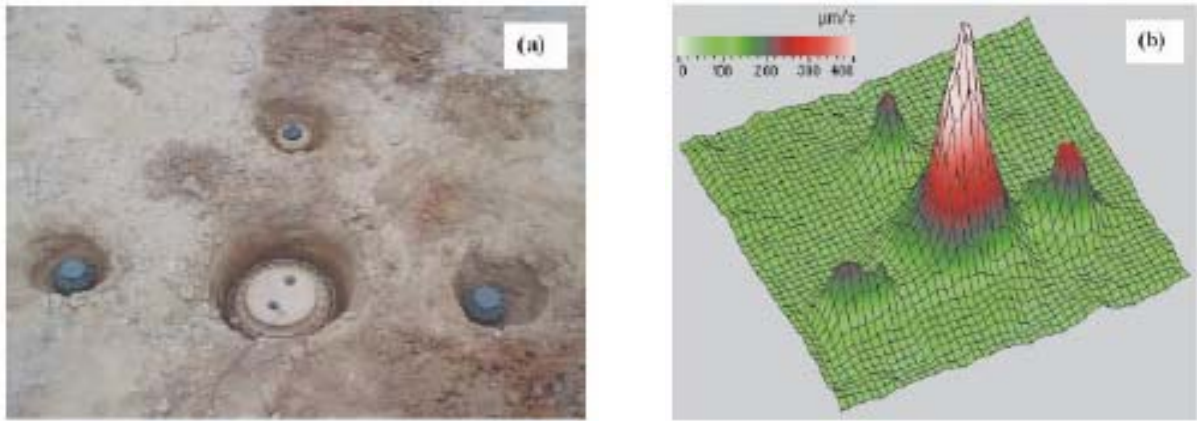

Figure 10 Scanning result on a combination of antitank and antipersonnel landmines. A plastic VS 2.2 antitank mine, 24 cm in diameter, was buried 6 cm deep surrounded by three plastic antipersonnel mines (two TS 50 mines on opposite sides of the antitank mine and one VS 50). These three antipersonnel mines, 9 cm in diameter, were buried 3 cm deep. A grid of 49 by 49 points covering an area 1.1 by 1.1 m<sup>2</sup> was defined, resulting in a spatial resolution of 2.3 cm. (a) Relative positions of the mines before burial in the natural soil. (b) The scanning results in a three-dimensional presentation. Magnitude spectra were integrated within the frequency range between  $f_1= 100$  and  $f_2= 300$  Hz.

The integration of the velocity magnitude spectrum for each scanning grid point was performed within a narrow frequency band. This narrow-band procedure was repeated by stepping through the entire frequency range with an overlap from one frequency band to the next. The narrow band analysis was based on an adequate frequency resolution (spacing) in the data. Improved frequency resolution made it possible to optimize the narrow-band analysis. The consistency in the position and size of a target enhanced distinguishing mines from background clutter. Higher frequency resolution, however, required collecting a larger number of data points.

The scanning time of the single-beam technique is determined by the spatial and frequency resolutions. For example, with a frequency resolution of 10 Hz covering an area of 30 by 30 cm<sup>2</sup>, the scanning took about 10 minutes.

In another experiment [R16], in order to increase the scanning speed the LDV-based acousto-seismic landmine detection system was mounted on a moving vehicular platform, and a feasibility study using a continuously-moving laser beam [R16] from a single-beam LDV system was carried out. In this study, the laser beam was moved continuously along a sweeping trace as shown in Fig. 11, while it was used to measure the instantaneous velocity of the ground surface caused by acoustic excitation. The continuous movement of the laser beam was arranged to scan a rectangular area of a determined size. A similar analysis to that used for stop-stare measurements was also applied to the moving beam measurements.

The scanning time of moving beam technique depends on the velocity of the laser beam movement and the system's frequency resolution. The response velocity from AT mines buried at 2.5 cm became too weak to tolerate the increased noise floor at a speed of 0.8 m/s; in fact a significant increase in the detection speed may result in a reduced probability of detection. The typical scanning time for this technique was about 40 s/m<sup>2</sup> for AT mines [R16].

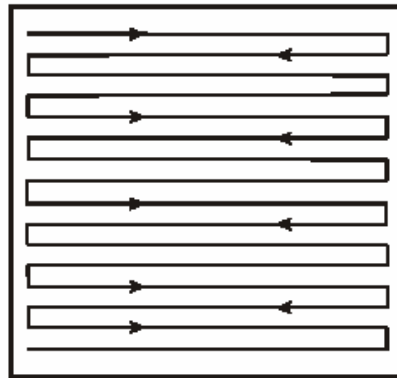

*Figure 11 Beam pattern for scanning an area. The beam moves continuously across horizontal lines with a constant speed while stepping down when the beam arrives at the edge of the pre-defined area. The instantaneous velocity response on the ground surface is measured by the moving laser beam [R13], [R16], [R12].*

Another solution was also proposed to increase the operational speed of the acousto-seismic landmine detection system: an array of multiple single-beam LDV systems can be employed to cover a wider interrogation span. A multiple LDV system on a moving platform using up to 16 single-beam LDVs has been investigated in field experiments. A span of 1 m wide can be simultaneously scanned with a spatial resolution of 7 cm. This multiple LDV concept has been implemented onto a vehicular platform and the platform can be moved at a constant speed along a road. Fig. 12 shows a photo of the platform.

The multi-point vibrometer is based on a diode pumped solid-state laser, a diffractive optical element (DOE), and an array of fibre-coupled photo-detectors. The DOE produces 16 beams from the single diode pumped solid-state laser. The 16 beams are spread uniformly across a 1-metre line over an angle of 22 degrees, and the displacement sensitivity of each beam was reported to be better than 1 nanometre.



Figure 12 Photograph of the moving platform with multiple Laser Doppler Vibrometers [R12].

A collection lens collimated the light from each of the 16 beams. However, since the 16 object beams travel through the centre of the collection lens, their path is unaltered and they retain the same angle originally imposed by the DOE. The reference beam is also divided into 16 beams as it passes through a DOE identical to that of the object beam. The 16 object beams and the 16 reference beams are combined at the beam combiner. A final lens, placed one focal distance away from the collection lens, makes the 16 object-reference beam pairs parallel and focuses them onto 16 individual fibre-coupled detectors. Each detector is then digitised with a 16 channel A/D card in a computer, and the target velocity at each beam is calculated by software.

LDV can be used both for linear and non-linear seismo-acoustic approaches (see *Summary Table* sec. 1.3). The ability to sense the surface vibration in a non-contact and remote manner, the ease of controlling the laser beams for scanning a large area, the ability to achieve a reasonable stand-off distance and the possibility to detect AP, AT mines and unexploded ordnance are major advantages of LDV-based systems applied to landmine detection. The disadvantages of LDV-based systems are their sensitivity to vegetation, their high cost, the long time required to scan larger areas, and their low portability.

### 2.2.3. Radar Doppler Vibrometer (RDV)

For the case of seismic excitation, a CW Radar with carrier frequency of about 8 GHz can be used to sense the vibration of mines. Electromagnetic waves from a radar transmitting antenna illuminate an area of the ground surface, and the electromagnetic signal reflected from the ground surface is received by a second antenna and is demodulated to achieve surface vibration displacement responses. A homodyne system has been used with in-phase and quadrature mixers to demodulate the received signal. Thanks to phase-demodulation, the RDV can measure displacements with resolution of 1 nm under laboratory conditions and this was reported to be sufficient to measure surface vibration displacements in the field of the order of 1  $\mu\text{m}$  [R9]. By increasing the carrier frequency a larger Doppler frequency shift is obtained, and consequently a higher sensitivity. This choice is counterbalanced by a higher degree of technological challenge, which leads to more expensive equipment.

RDVs have been used to detect AT mines with target depth up to 20 cm, and AP mines with target depth up to 7 cm.

The RDV offers a number of advantages. It is a non-contact sensor, is complementary to conventional metal detectors, and can find mines with a wide variety of types of casing (not just those with metal). The RDV can be made lightweight and easy to operate.

However, natural subsurface inhomogeneities (such as roots, rocks, and water pockets) can also interact with the probing acoustic field, causing surface vibrations which represent a source of false

alarms. In addition, RDV performance can be highly sensitive to complex interactions among mine metal content, operating frequency, soil moisture profiles, and the smoothness of the ground surface interface.

The time of scanning is very high (more than 8 hours/m<sup>2</sup>) due to the difficulty of discriminating targets from subsurface inhomogeneities (roots, rocks, and water pockets).

#### 2.2.4. Ultrasonic Doppler Vibrometer (UDV)

Ultrasonic Doppler devices are much less expensive than other non-contact sensors, but less standoff is achievable. A feasibility study of a low-cost Ultrasonic Doppler Vibrometer (UDV) is being conducted at The University of Mississippi [R17]. The carrier frequency of the UDV is chosen to be in the range of 50-120 kHz. Besides cost, an ultrasonic sensor offers some additional advantages over electromagnetic and laser sensors:

- Speckle size is larger than that of an LDV, making an UDV virtually insensitive to horizontal target motion.
- The operating frequency is easy to adjust to improve the penetration through low-lying vegetation (grass, pine needles, leaves).
- The constraints to the electronics and signal processing are less demanding.
- UDV gives direct access to the carrier signal, without the need for down-conversion electronics.

It is, however, a challenging task to achieve an acceptable UDV sensitivity for landmine detection. For weak vibrations, the amplitude of the received signal is proportional to the amplitude of the incident pressure and inversely proportional to the speed of sound in the medium (assumed constant and uniform). An experimental implementation of an UDV system is shown in Fig. 13 [R12].

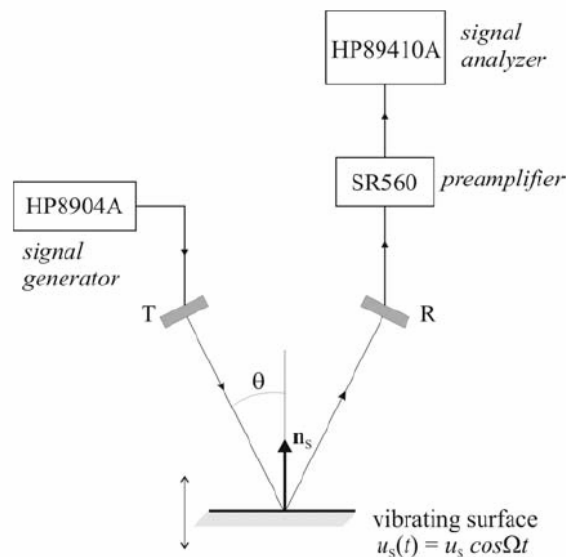

Figure 13 Schematic of experiment configuration with Ultrasonic Doppler Vibrometry detection.

Fig. 14 illustrates the spectrum amplitude of a typical signal, with a carrier (120.4 kHz) phase-modulated by a surface vibrating at 150 Hz [R12].

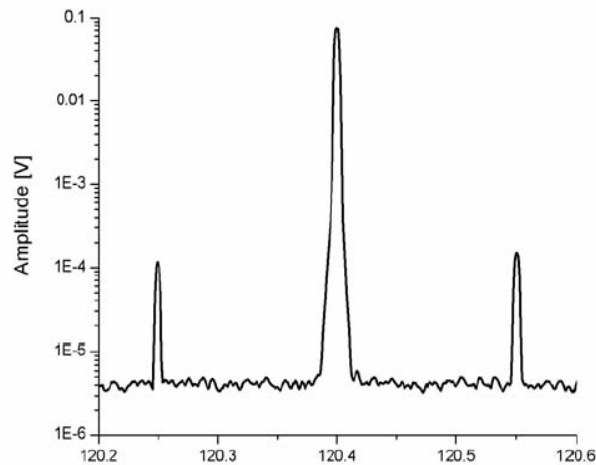

Figure 14 Typical spectrum amplitude of an ultrasonic Doppler signal showing the carrier and the 1st order sidebands ( $120.4 \pm 0.150$  kHz).

In [R12] a comparison between LDV and UDV has been performed on an experimental basis, with the result that a UDV was able to accurately follow the surface vibration characteristics with comparable performance to an LDV. The detrimental influence of air motion on both UDV and LDV systems was also considered during these tests, especially the induced motion of any vegetation covering the investigated surface. Wind can move grass blades in particular in complex, unsteady motion. In such cases, the LDV can experience very significant signal loss due to speckle-induced spatial de-coherence. The UDV is less sensitive to this effect [R12].

An upper limit for the operating frequency of the UDV is due to the attenuation coefficient in air being proportional to the square of frequency. In standard conditions (Temperature 25°C, Relative Humidity 50% and pressure 1 atm) the extinction distance E.D. in air is defined by:

$$E.D. = 5 \times 10^{13} / f^2 \quad (7)$$

where *E.D.* is the distance in mm at which the pressure field drops to 1/e of its initial value and *f* is the frequency in Hz. Table 2 reports values of E.D. for some operating frequencies of commercial airborne ultrasonic transducers.

Frequency[kHz]	Extinction Distance[mm]
50	20000
150	2222
420	283

Table 2. Extinction distance for some frequencies of commercially available airborne ultrasonic transducers.



### 2.2.5. Acoustic Microphones

If the acoustic impedance of a buried object is sufficiently different from the surrounding medium, then an incident acoustic pulse will be partially reflected back and can be detected, especially if it is time isolated from other pulses. This principle applies to non-metallic as well as metallic objects, which allows the plastic casings often used for landmines to be located. A major problem is to isolate the small object pulse from other, perhaps dominant, signals.

To achieve this goal, a system based on the following principle has been trialled [R18]. A loudspeaker source emits sound pulses of about 1 ms duration. With no buried object, the difference signal between two equally spaced microphones  $M_1$  and  $M_2$  (see Fig. 15) is ideally zero as the direct pulses from the source and the ground surface reflections cancel. With a buried object present, a small delayed reflection remains after subtraction of the microphone signals. Further, the depth of the object can be determined from the delay of its reflection compared to that from the surface.

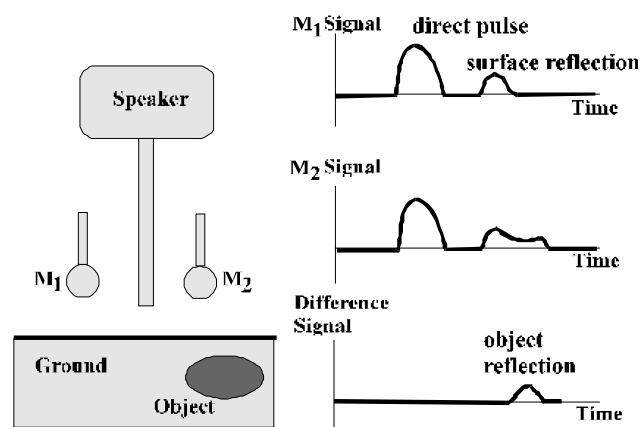

Figure 15 Schematic set-up and received signals for acoustic detection using acoustic pulses and two microphones  $M_1$  and  $M_2$  [R18].

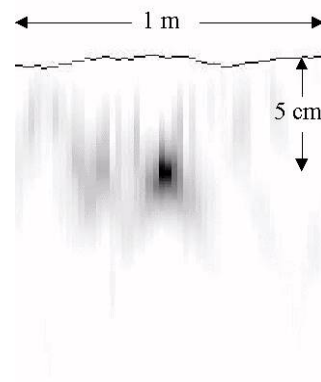

Figure 16 Example of the type of the image produced using acoustic impulses [R18] with a scanning system over a 1 m linear range and buried object at 5 cm depth.

Fig. 16 shows an example of the type of image obtained using acoustic impulses. Signals referred to a 12 cm diameter plastic landmine located about 5 cm below the surface of a lightly compacted loamy garden soil with agglomerates ranging up to 2 cm in diameter scattered over the surface.

Ground contours and irregularities cause the timing of the surface reflection to vary, leaving significant residues which swamp the object reflection if simple subtraction is used. Consequently, precise alignment of the two pulse waveforms before subtraction is required to reduce this residue. One difficult consideration is whether or not to arbitrarily scale the two peaks to have the same height. It may be that one is larger because the surface is closer or that a more reflective object, such as a landmine near the surface, is causing enhancement.

Improvements are possible by using more microphones, especially off the line of the detector sweep, to pick up sideways reflections from curved objects.

In another experiment [R5] microphones were used to measure the acoustic pressure in order to calculate the acoustic impedance defined in Eq. (3). In this case the impedance of soil surface was determined by applying an external pressure (frequency swept sound waves from a speaker) and measuring the acoustic pressure,  $p$ , with a microphone suspended about 10 mm above the surface. The resulting vibration velocity,  $v$ , was measured with an LDV or a geophone and the impedance (per unit area) was calculated (see Eq. (3)).

### 3. Methods and Experimental Set-up for an Acoustic Landmine Detection System

#### 3.1. Proposal for an Experimental Activity

On the basis of the experiments described above, a list of possible experiments has been drawn up which could be carried out with the limited budget and short time scale assigned for this *Study*. This includes experimental work with new signal processing techniques:

##### Experiment n.1

This experiment is based on the method proposed by Don *et al.* [R18], which generates acoustic waves which propagate into the soil from a loudspeaker. The induced oscillation of a shallow minelike object (or mine surrogate) is captured by two or more microphones placed at a determined height and inclination with respect to the soil surface. A scanning system is necessary to map the soil surface with this kind of transmitter-receiver probe.

The experiment should indicate the presence of a minelike target by comparison of the signals received by these two or more microphones. As shown in Fig. 15 the characteristic response of a compliant casing can be differentiated from a solid buried object by subtraction of the two signals. There is an ambiguity when the transmitter-receiving system is placed exactly over the mine and the two signals are in theory identical.

This experiment also permits excitation of non-linear modes by adjusting both the frequency and the power of the excitation signal. According to theory and previous experiments reported in the literature, a pair of loudspeakers can be used, one transmitting a CW signal and the second a frequency modulated signal. Programmability of frequency and amplitude is provided by using an arbitrary function generator driving a linear power amplifier.

Moreover a new signal processing method is proposed for the detection of non-linear effects, by means of two opposite phase excitation signals. We can describe the time domain signal response in a polynomial form as:

$$V_{out}(t) = b_0 + b_1 V_{exc}(t) + b_2 V_{exc}^2(t) + \dots \quad (8)$$

where the coefficients ( $b_0, b_2$ ) and  $b_1$  are related to the non-linear and linear response respectively;  $V_{exc}(t)$  is the excitation signal.

The second harmonic distortion due to the parabolic term  $b_2$  doesn't change when the sign of  $V_{exc}(t)$  is changed by a 180° phase delay. The summation of the received signals obtained with these two conditions (0° for  $V_{exc}(t)$  and 180° for  $V_{exc}(t)$ ) will eliminate the linear terms and only the non-linear contribution will be detected.

##### Experiment n.2

The detection method proposed for a new experiment is an Ultrasonic Doppler Vibrometer operating in air. The experiment employs the same type of acoustic excitation described in Experiment n.1 but the vibrometer consists of an airborne ultrasonic probe. This probe has a transmitting transducer emitting a CW or long tone burst<sup>3</sup> directed towards a point of the soil surface and a similar receiving transducer pointing toward and focussed on the same point. Suitable transducers might be the Murata MA 200 type, operating at 200 kHz, with low insertion losses, high directivity and small bandwidth. The Doppler effect results in a frequency shift of the

---

<sup>3</sup> A tone burst is a wave formed by one or more cycles of a sine/cosine wave at a certain frequency.

central frequency of the transmitted spectrum, and this can be detected by a suitable signal demodulation chain. Due to the high sensitivity required to detect vertical soil displacements of the order of 10  $\mu\text{m}$  a receiver with a wide dynamic range and low noise must be developed, with a gain of 80-100 dB, depending on the ultrasonic probe's height above soil. The system design also requires careful characterization of transducer bandwidth and directivity to take into account possible differences between the transmitter and the receiver.

This vibration detection method opens the possibility of implementing a rather new technique, called *Vector Doppler*, that has been the subject of experiments for medical applications by our group [R19]. Vector Doppler is capable of detecting both direction and magnitude of the velocity in real-time. The probe is in this case made of one transmitter and three receivers directed and focussed at the same point. By means of this special probe, the Doppler shift is measured along three different directions and the corresponding velocity components are used to calculate direction and magnitude of the soil vibration at the focussed point independently from the probe orientation. This constitutes a significant step forward for a feasibility study of a portable low-cost instrument with a dedicated array of airborne transducers, that can be manufactured at low cost from a piezoelectric film such as PVDF [R20]. The detection of the Doppler shift can be done with a standard analogue synchronous demodulator, which can also be readily implemented by means of digital techniques [R21]. A third possibility would be to detect the frequency modulation via a phase lock circuit.

### Experiment n.3

This experiment is based on the method proposed by Donskoy *et al.* [R2], [R3], [R5] that measures the soil acoustic impedance (see Eq. 3) using pressure and velocity sensors. The impedance of the soil surface was determined by applying an external pressure (frequency swept sound waves from a loudspeaker) and measuring the acoustic pressure  $p$  with a microphone suspended at about 10 mm above the surface, and the velocity with a geophone placed above or next to the target.

The experiment should indicate the presence of a minelike target by comparing the impedance measurement received from the soil with and without targets at specified frequencies.

A limitation for real applications is the risk associated with placing a geophone in good contact with the soil and close to a mine. This limitation has to be considered even if the sensors can be placed in the safe operating area.

The extension of the acoustic impedance technique to scan larger areas (rather than to work in confirmation mode) is not straightforward, and requires an array of geophones, as described in section 2.2.1, to reduce the scanning time.

## **3.2. Experiment Organization**

The proposed experiment for the second phase of this project is the first one described above. It is preferred because of the lack of such experimental data in the literature and because it looks feasible within the time constraint of this project (two months). Experiment n.2 is also interesting but would require more dedicated hardware; a measurement session will therefore only be attempted using instruments already available in the laboratory (commercial probes, amplifier and lock-in). If interesting results are obtained they will be reported in the *Study's* Final (experimental) Report. Furthermore, we believe that a feasibility study for the UDV requires in itself a dedicated project.

Experiment n.3 is quite simple and does not require much hardware to be developed or assembled. However, quite a few measurements have already been reported in the literature for this application.

### Required Instrumentation

- Two high sensitivity microphones with bandwidth (-3dB) of at least 100 Hz–15 kHz.
- Arbitrary function generator (e.g. HP33120A).
- Power Linear Stereo Amplifier ( $\geq 150$  W).
- Two loudspeakers ( $\geq 170$  W).
- Digital oscilloscope (e.g. Tektronix TDS3000 with real time FFT module) or data acquisition card + laptop PC.
- Tripods for microphones and loudspeakers.
- Humidity and temperature control probe.
- Acoustic shields/absorbers.

### Measurement Campaign and Test Protocol

The measurement campaign will be performed on simulated compliant targets (minelike object or landmine surrogates) and a non-compliant object (e.g. stone) buried in homogeneous soil. The test-bed will have an area of 9 m<sup>2</sup> (3m by 3m), 0.5 m deep, filled with sand. The target will be tested at three different depths (1 cm, 5 cm, and 10 cm) in a horizontal position; the false alarm rate will also be evaluated.

Raw data will be recorded during the experiments and a description of the experimental set-up will be provided.

The power amplifier will be set to two different output levels capable of differentiating between linear and non-linear operating conditions.

Pulses of duration of the order of 1 ms will be transmitted at suitable repetition rate (PRF) to avoid spurious signals from multiple reflections due to the surrounding environment. In the case of significant interference from spurious signals acoustic shields and absorbers will be used. Determination of the directivity of the acoustic source will be included in this feasibility study.

### Expected Results

The results expected from this test campaign are (relative to experiment n.1):

- Definition of an experimental set-up and of the corresponding operating conditions.
- Demonstration of the technique operating with acoustic waves with linear or non-linear effects.
- A study of the signal processing required for a good discrimination between the two targets.
- Criteria for the optimization of the system (dimension, weight, power consumption, etc).

If positive results can be obtained with experiment n.2, a section in the *Study's* Final (experimental) Report will outline indications for the development of an airborne UDV system.

## 4. Conclusions

For the evaluation of the future prospects of the acoustic techniques which have been identified (see *Summary Table*), it is necessary to:

- (a) Identify the key obstacles to the use of a given technique in mined areas,
- (b) Identify ways to solve these key problems,
- (c) (if possible) Quantify the limits of the described techniques.

A brief explanation of these issues is reported below for the main excitation and detection techniques reported in the literature.

### Acoustic Waves Excitation

Suitable techniques are those using non-contact methods for insonifying the selected area of the soil; these techniques use loudspeakers with RMS power in the 100-200 W range placed in air at a specified height (0.1-1 m). The sound power level can be adjusted to induce a non-linear response by the buried landmines. The drawbacks of these systems are the direct interaction of sound (generally in the frequency range 100-1000 Hz) with the receiving sensors/apparatus, and acoustic noise generated in the environment. The acoustic coupling with the soil is also inefficient; high power amplifier and loudspeakers are therefore necessary. To limit direct acoustic coupling with the source, acoustic shields and absorbers for the detectors are generally required. The use of a linear amplifier has the additional advantage of allowing the investigation of modulated excitation signals (e.g. tone bursts of 1-10 ms duration).

### Seismic Waves Excitation

An efficient way to excite seismic waves in the soil is by using an electrodynamic shaker buried in the soil at about a metre distance from the area under investigation. When working in this way some time is required to put the device in operation in a cleared area. As shown in the *Summary Table*, this method is not suitable for devising fast scanning systems. Electrodynamic shakers suitable for this application do not seem to be commercially available at present.

### Acoustic Impedance Measurements

This method, which has been mainly developed by Donskoy *et al.*, has been thoroughly investigated with different live mine types in test fields and good agreement with acoustic equivalent models (linear and non-linear) has been found. However, the acoustic impedance has to be measured with a stand-off microphone for pressure level, and with a geophone/accelerometer, in contact with the soil, for surface velocity. The placement of geophones on irregular soil surfaces can be critical for the detection performance; the achievable scanning time is also seriously limited. To overcome this problem two different non-contact techniques have been recently proposed to detect the soil vibration: Ultrasonic and Radar Doppler Vibrometer. Following the extensive experiments carried out using Laser Doppler Vibrometers by Sabatier *et al.*, these two methods can be considered as candidates to be implemented in a portable system<sup>4</sup>. Their major limitations are probably the different response of the sensors against varying target depth and environmental factors (wind, soil moisture, vegetation). Scott *et al.* used a Radar interferometer to discriminate between UXO, rocks, etc, and landmines with compliant casings.

---

<sup>4</sup> By "portable equipment" we commonly mean equipment which is easily carried (transportable/ movable).

### Acoustic Detection of Reflected Sound from a Buried Target

A full non-contact method was proposed by Don *et al.* [R18] with a technique employing two stand-off microphones to detect the sound reflected from the target, and a loudspeaker excitation system. The advantages of this method are the fast scanning time and the differential acquisition from two different microphone positions. In this way it becomes possible to discriminate the presence of a mine by comparing the two received signals; in addition, suitable signal processing techniques can be implemented to emphasize the non-linear contribution of the mine resonance. The major limitation of this method is probably the inefficient acoustic coupling between the airborne system and the soil, both in transmission and in receiving mode. Also, at the low end of the audible frequency range, high sensitivity microphones are only available with isotropic or cardioid function directivity patterns. This means that mine location can be estimated by measuring the reflected signal at different positions, for example employing a raster scan for surface mapping. Recently, the US Naval Research Laboratory [R22] proposed a research program where high sensitivity airborne piezo-polymer film (PVDF) transducers would be employed. This type of acoustic detector, when arranged in form of an array, or when length extensional vibration is exploited, can provide a narrower directivity pattern at the price of larger overall dimensions.

## 5. References

- [R1] "Non-linear seismo-acoustic technique for landmine detection and discrimination", D. M. Donskoy, Second International Conference on Detection of Abandoned Land Mines, IEE Conference Publication No. 458, pp. 244-248, Edinburgh, UK, October 1998
- [R2] "Optimization of seismo-acoustic land mine detection using dynamic mechanical impedances of mines and soil", D. Donskoy, N. Sedunov, A. Ekimov, M. Tsionskiy, Detection and Remediation Technologies for Mines and Minelike Targets VI, Proceedings of SPIE, Vol. 4394, pp. 575-582, Orlando, USA, 2001
- [R3] **"Non-linear seismo-acoustic land mine detection and discrimination", D. Donskoy, A. Ekimov, N. Sedunov, M. Tsionskiy, J. Acoust. Soc. Am., Vol. 111, No. 6, pp. 2705-2714, June 2002**
- [R4] "Use of elastic waves for the detection of buried land mines", W. R. Scott Jr., C. T. Schroeder, J. S. Martin, G. D. Larson, white paper (<http://www.ee.duke.edu/~lcarin/DeminingMURI/>)
- [R5] "Nonlinear seismo-acoustic land mine detection: field test", D. Donskoy, A. Ekimov, N. Sedunov, M. Tsionskiy, Detection and Remediation Technologies for Mines and Minelike Targets VII, Proceedings of SPIE, Vol. 4742, pp. 685-693, Orlando, USA, 2002
- [R6] **"Nonlinear acoustic Techniques for land mine detection", M. S. Korman, J. M. Sabatier, white paper (<http://www.demine.org/SCOT/Papers/Sabatier.pdf>)**
- [R7] "Nonlinear acoustic waves in porous media in the context of Biot's theory", D. M. Donskoy, K. Khashanah, T. G. McKee Jr., J. Acoust. Soc. Am., Vol. 102, No. 5, pp. 2521-2528, Nov. 1997
- [R8] "A hybrid acoustic/electromagnetic technique for locating land mines", W. R. Scott, C. Schroeder, J. Martin, Geoscience and Remote Sensing Symposium Proceedings, IEE International, Vol.1, pp. 216-218, July 1998
- [R9] "Experimental model for a seismic landmine detection system", W. R. Scott Jr., J. Martin, G. D. Larson, IEEE Transactions on Geoscience and Remote Sensing, Vol. 39, No. 6, pp. 1155-1164, June 2001
- [R10] "Local interaction simulation approach to modelling nonclassical, nonlinear elastic behaviour in solids", M. Scalerandi, V. Agostini, P. P. Delsanto, J. Acoust. Soc. Am., Vol. 113, No. 6, pp. 1-11, June 2003
- [R11] "Land mine detection measurements using acoustic-to-seismic coupling", N. Xiang, J. M. Sabatier, Detection and Remediation Technologies for Mines and Minelike Targets V, Proceedings of SPIE, Vol. 4038, pp. 645-655, Orlando, USA, 2000
- [R12] **"Vibration sensors for buried landmine detection", J. M. Sabatier, N. Xiang, A. G. Petculescu, V. Aranchuk, M. Bradley, 2003, white paper (<http://symphony.arch.rpi.edu/~nxiang/Publications.html>)**
- [R13] "Application of acoustic-to-seismic coupling for landmine detection", N. Xiang, J. M. Sabatier, April 2002, white paper (<http://symphony.arch.rpi.edu/~nxiang/Publications.html>)
- [R14] "An investigation of acoustic-to-seismic coupling to detect buried antitank landmines", J. M. Sabatier, N. Xiang, IEEE Transactions on Geoscience and Remote Sensing, Vol. 39, No. 6, pp. 1146-1154, June 2001
- [R15] **"An experimental study on antipersonnel landmine detection using acoustic-to-seismic coupling", N. Xiang, J. M. Sabatier, J. Acoust. Soc. Am., Vol. 113, No. 3, pp. 1333-1341, March 2003**
- [R16] "Acoustic-to-seismic land mine detection using a continuously scanning laser Doppler vibrometer", N. Xiang, J. M. Sabatier, Proceedings of SPIE, Vol. 5089, Detection and Remediation Technologies for Mines and Minelike Targets VIII, pp. 591-595, Orlando, USA, 2003
- [R17] "Feasibility study of an air-coupled acoustic sensor for measuring ground vibrations", A. G. Petculescu, J. M. Sabatier, Proceedings of SPIE, Vol. 5089, Detection and Remediation Technologies for Mines and Minelike Targets VIII, pp. 487-494, Orlando, USA, 2003



- [R18] **"Location of buried objects by an acoustic impulse technique", C. G. Don, A. J. Rogers, Acoustic Australia, Vol. 22, No. 1, pp. 5-9, 1994**
- [R19] "A 3D PW ultrasonic Doppler flowmeter: theory and experimental characterization", M. Calzolari, L. Capineri, A. Fort, L. Masotti, S. Rocchi, M. Scabia, IEEE Transactions on UFFC, Vol.46, N.1, January 1999
- [R20] "Piezo-polymer transducers for ultrasonic imaging in air", L. Capineri, A.S. Fiorillo, L. Masotti, S. Rocchi, IEEE Transactions on UFFC, vol.44, No. 1, January 1997, pp. 36-43
- [R21] "Real-time digital demodulation technique for ultrasonic Doppler signal", M. Calzolari, L. Capineri, A. Fort, P. Lucetti, L. Masotti, M. Scabia, Alta Frequenza-Rivista di Elettronica, Vol.10, N.2, Marzo-Aprile 1998, pp. 51-55
- [R22] "USMC Basic Research Focus Program (Landmine Detection Research Area)", Clifford W. Anderson, presented at 6<sup>th</sup> Annual Landmine Basic Research Technical Review 2003, Office of Naval Research, Code 353(703) 696-4485, anderscw@onr.navy.mil

### Other Interesting Articles

- [R23] "Nonlinear seismo-acoustic land mine detection", D. M. Donskoy, A. E. Ekimov, N. Sedunov, M. Tsionskiy, JASA abstract, 142nd Meeting: Acoustical Society of America, <http://www.acoustics.org/press/142nd/donskoy2.html>
- [R24] **"Alternatives for landmine detection", J. MacDonald, J.R. Lockwood, J. McFee, T. Altshuler, T. Broach, L. Carin, R. Harmon, C. Rappaport, W. Scott, R. Wheeler, Cap. 2, Appendix H, RAND Science and Technology Policy Institute, Report MR-1608, 2003**
- [R25] "Novel methods for detecting buried explosive devices", S. W. Kerckel, R. S. Burlage, D. R. Patek, C. M. Smith, A. D. Hibbs, T. J. Rayner, SPIE, Vol. 3079, pp. 467-477, 1997
- [R26] "Acoustic to seismic coupling and detection of landmines", J. M. Sabatier, N. Xiang, Geoscience and Remote Sensing Symposium, Proceedings IEEE International, Vol. 4, pp. 1646-1648, 2000
- [R27] "A finite difference model to study the elastic-wave interactions with buried land mines", C. T. Schroeder, W. R. Scott Jr., IEEE Transactions on Geoscience and Remote Sensing, Vol. 38, No. 4, pp. 1505-1512, July 2000
- [R28] **"Dynamic nonlinear elasticity in geomaterials", L. A. Ostrovsky, P. A. Johnson, Rivista del Nuovo Cimento © Società Italiana di Fisica, Vol. 24, No. 7, pp. 1-48, 2001**
- [R29] "Laser Doppler Vibrometer-based anti-personnel mine detection", J. M. Sabatier, N. Xiang, Geoscience and Remote Sensing Symposium, IEEE International, Vol. 7, pp. 3093-3095, July 2001
- [R30] "LISA simulations of time-reversed acoustic and elastic wave experiments", P. P. Delsanto, P. A. Johnson, M. Scalerandi, J. A. TenCate, Journal of Physics D: Applied Physics, Vol. 35, pp. 3145-3152, 2002
- [R31] "Impact of nonlinear effects on a high-frequency seismic landmine detection system", G. D. Larson, J. S. Martin, P. H. Rogers, W. R. Scott Jr., 5<sup>th</sup> International Symposium Technology and The Mine Problem, Monterey, USA, April 2002
- [R32] **"A Multidisciplinary Analysis of Frequency Domain Metal Detectors for Humanitarian Demining", C. Bruschini, PhD Thesis, Vrije Universiteit Brussel (VUB, Belgium), Faculty of Applied Sciences, Sept. 2002, 230 pp., ISBN 3-89825-853-X**
- [R33] **"Resonance vibrations of buried landmine", A. Zagrai, D. Donskoy and A. Ekimov, SPIE Defense & Security Symposium, pp. 12-16, April 2004, Kissimmee, Florida, USA. Paper # 5415-3**

## Patents

- [P0] "*Metal Detectors for Humanitarian Demining: a Patent Search and Analysis*", C. Gaudin, C. Sigrist, C. Bruschini, EUDEM2 Report, Nov. 2003, v2.0 (<http://www.eudem.info/>)
- [P1] "Acoustic detection apparatus", D. D. Caufield, US Patent No. 4922467, 01 May 1990
- [P2] "Method and apparatus for acoustic energy identification of objects buried in soil", L. J. House, D. B. Pape, US Patent No. 5357063, 18 October 1994
- [P3] "Object detector for detecting buried objects", A. J. Rogers, C. G. Don, US Patent No. 5563848, 08 October 1996
- [P4] "Method and apparatus for acoustic detection of mines and other buried man-made objects", D. Donskoy, A. Sutin, US Patent No. 5974881, 02 November 1999
- [P5] "Method for detecting buried objects by measuring seismic vibrations induced by acoustical coupling with a remote source of sound", K. E. Gilbert, J. M. Sabatier, US Patent No. 6081481, 27 June 2000
- [P6] "Method and apparatus for acoustic detection of mines and other buried man-made objects", D. Donskoy, A. Sutin, US Patent No. 6134966, 24 October 2000
- [P7] "Method and apparatus for remote measurement of vibration and properties of objects", D. Donskoy, N. Sedunov, E. A. Whittaker, Patent No. WO0114825, 01 March 2001
- [P8] "Method and apparatus for acoustic detection of mines and other man-made objects", D. Donskoy *et al.*, US Patent No. 6415666, 09 July 2002
- [P9] "Mapping reservoir characteristics using earth's nonlinearity as a seismic attribute", Khan Tawassul A., US Patent No. 20020134612, 26 September 2002

**NOTE: Main articles and Tutorials are highlighted in bold.**

## 6. Appendix A: Field Tests

Some field test campaigns on acoustic/seismic sensors have been carried out in the last five years or are now in progress. These tests involved the following organisations:

1. *Stevens Institute of Technology*

*Principal investigator:* Dimitri Donskoy

*Details:* Acoustic impedance measurements using a scanning LDV for velocity measurements and a microphone for pressure measurements. Field tests have been carried out in 2000 making impedance measurements of over 50 different "live" mines (real mines with explosives but with some part of the detonation chain removed or disabled).

2. *Georgia Institute of Technology* in collaboration with *Cyterra Corporation*, and sponsored by the U.S. Office of Naval Research, the U.S. Army Research Office and the U.S. Army Night Vision & Electronic Sensors Systems Directorate

*Principal investigator:* Waymond Scott

*Details:* Seismic mine detection system using an 8 GHz radar-based non-contact displacement sensor as the receiver. Field test unit fabricated and field tests at first eight sites completed in June 2003.

3. *University of Mississippi*

*Principal investigator:* James Sabatier

*Details:* Acoustic/seismic buried landmine detection using an LDV or a geophone as the receiver. Field tests, aimed at enhanced understanding of the mechanisms responsible for false indications in acoustic/seismic landmine detection, are in progress.

4. *U.S. Naval Research Laboratory*

*Principal investigator:* Kirth Simmonds and Richard Mignona

*Details:* Acoustic detection of landmine using a PVDF sensor as the receiver. Field tests in progress.

## 7. Appendix B: Acoustic Landmine Detection<sup>5</sup>

Acousto-seismic methods detect mines by vibrating them with acoustic (non-contact sensors) or seismic waves (contact sensor) and measuring the effect. These methods are based on the mechanical properties (e.g. compliance: the displacement of a linear mechanical system under unit applied force) that can differentiate mines from other objects in the ground. Prototype systems have been developed and tested recently.

### General

A large fraction of the acoustic energy transmitted by a loudspeaker is reflected off the ground surface, but some penetrates into the ground in the form of seismic waves that propagate through the soil. In presence of a buried mine, some of the energy insonifying the mine casing causes a detectable vibration at the ground surface. Remote sensors can detect these vibrations above the ground. Typical mine casing material that can show this effect are thin membranes made of metal, plastic, or wood.

The mine casing is in contact with the soil in which it is buried and is assumed to have a compliance which is notably different from the one of the surrounding soil.

The basic principle of the acousto-seismic approach is to excite with low frequency waves (typically below 1000 Hz) a vibration in a buried mine; this vibration is measured on the soil surface above the mine using remote sensors like Laser Doppler Vibrometer (LDV), Radar Doppler Vibrometer (RDV), Ultrasonic Doppler Vibrometer (UDV), contact sensors like geophones/accelerometers, and is used as an "acoustic signature".

### Linear and Non-Linear Acousto-seismic Methods

During the excitation with an acousto-seismic wave, the dynamic interaction between the compliant case and the column of soil above the mine leads to specific linear and non-linear effects used for mine detection. Non-linear effects are due to the discontinuity at the top interface between the mine cap and the soil, and/or the non-linear response of porous soils.

### Prototype Systems

- Impedance acoustic measurement system using a scanning LDV for velocity measurements and an acoustic microphone for pressure measurements.

Field tests have been carried out in the year 2000, conducting impedance measurements of over 50 different "live" mines (real mines with explosives but with some part of the detonation chain removed or disabled).

- Seismic mine detection system using an 8 GHz radar-based non-contact displacement sensor as the receiver.

Field test unit fabricated and field tests at the first eight sites completed in June 2003.

- Acousto-seismic buried landmine detection using an LDV or a geophone as the receiver.

Field tests, aimed at enhanced understanding of the mechanisms responsible for false indications in acoustic/seismic landmine detection, are in progress.

- Acoustic detection of landmines using a piezo-polymer film (PVDF) sensor as the receiver.

Field tests are in progress.

- Investigation of the impact of operational parameters such as mine characteristics, soil properties and climatic conditions, using a Scanning Laser Doppler Vibrometer (SLDV).

The first test campaign devoted to AT mines was carried out in the year 2000. The goal of the recent field test at the EC's Joint Research Centre (JRC) in Ispra (Italy) is to add AP mine signatures to the SLDV database.

---

<sup>5</sup> This section is intended as a short Summary for the EUDEM2 Website.

- Investigations into acoustic and seismic detection of buried objects as carried out at the ISL (Institut Franco-Allemand de Saint-Louis).  
See for example the report "Détection acoustique et sismique d'objets enterrés" (ISL rep. Nr R 126/98).

## **8. Appendix C: Companies and Research Institutions List**

Georgia Institute of Technology

Website: <http://www.gatech.edu>

Cytterra Corporation

Website: <http://www.cytterracorp.com/index.htm>

University of Mississippi

Website: <http://www.olemiss.edu>

U.S. Naval Research Laboratory

Website: <http://www.nrl.navy.mil>

Harvard (Harvard University)

Website: <http://seti.harvard.edu/mines>

ISL (Institut Franco-Allemand de Saint-Louis)

Website: <http://www.isl.tm.fr>

Stevens (Stevens Institute of Technology)

Website: <http://www.soe.stevens-tech.edu/News/donskoy.html>

Joint Research Centre (JRC)

Website: <http://demining.jrc.it/msms>