



UNIVERSITÀ
DEGLI STUDI
FIRENZE

DOTTORATO DI RICERCA IN
Psicologia e Neuroscienze

CICLO XXVI

COORDINATORE Prof. Renato Corradetti

*Stem cell biology in autoimmune diseases: a
characterization of mesenchymal stem cells
isolated from multiple sclerosis patients.*

Settore Scientifico Disciplinare MED/23

Dottorando

Dott. Bonechi Elena

Tutore

Prof. Massacesi Luca

Coordinatore

Prof. Renato Corradetti

Anni 2011/2013

INDEX

INTRODUCTION

1. MULTIPLE SCLEROSIS

- 1.1 Symptoms
- 1.2 Diagnosis
- 1.3 Clinical course
- 1.4 Causes
 - 1.4.1 Genetics
 - 1.4.2 Environmental factors
- 1.5 Pathogenesis
- 1.6 Treatment of multiple sclerosis

2. STEM CELL THERAPY IN MULTIPLE SCLEROSIS

- 2.1 Haematopoietic Stem Cell Transplantation (HSCT)
- 2.2 Neural Stem/Precursor Cells
- 2.3 Mesenchymal Stem Cells (MSCs)
 - 2.3.1 Definition
 - 2.3.2 History
 - 2.3.3 Characteristics
 - 2.3.4 Immunomodulatory properties
 - 2.3.5 Preclinical studies
 - 2.3.6 Clinical application
- Adverse event

3. IP-10

- 3.1 Chemokines
- 3.2 IP-10 gene
- 3.3 Function
- 3.4 Clinical relevance

4. TLRs

Innate immunity receptors

- TLRs
- TLR4 signaling

5. AIM

6. MATERIALS AND METHODS

- 6.1 Patients
- 6.2 Isolation, culture and characterization of BM MSCs
- 6.3 Cytokine and chemokine determination on MSCs and BM serum
- 6.4 IP-10 determination on peripheral blood monocytes
- 6.5 Analysis of, IFN- β , IP-10, STAT-1, NF- κ B and I κ B gene expression
- 6.6 Gene expression profile of MSCs: microarrays analysis
- 6.7 Signal transduction protein analysis
- 6.8 Mixed lymphocyte reaction (MLR)
- 6.9 Analysis of autologous T cell proliferation and IFN- γ secretion
- 6.10 Statistical analysis

7 Results

- 7.1 Patients
- 7.2 Cytokine and chemokine determination on cell supernatant
- 7.3 IP-10 production at different passage of cell culture
- 7.4 Alternative pathway for IP-10 production
 - 7.4.1 IFN- β
 - 7.4.2 Zymosan
- 7.5 Signaling proteins expression profile
- 7.6 Transcriptional analysis of TLR4 signaling pathway
- 7.7 Signal transduction protein analysis
- 7.8 Cytokine and chemokine determination on bone marrow serum

- 7.9 IP-10 production after AHSCT
- 7.10 Mixed lymphocyte reaction (MLR)
- 7.11 Proliferation test: effect of MSCs on autologous T cells
 - 7.11.1 IFN- γ production
- 7.12 IP-10 production on peripheral blood monocytes
- 7.13 Signaling proteins expression profile
- 7.14 IP-10 production on peripheral blood monocytes after AHSCT
- 7.15 Signaling proteins expression profile

8 Discussion

INTRODUCTION

1 MULTIPLE SCLEROSIS

Multiple sclerosis (MS) is an inflammatory demyelinating disease of the central nervous system (CNS) with myelin debris accumulation and oligodendrocyte and axonal loss, which is thought to be mediated by autoimmune response to self-antigens in a genetically susceptible individual (Hafler DA et al, 2004).

In 1868 Jean Martin Charcot was the first who recognized MS as an independent illness and established the connection between symptoms and nerve damage (Marie P: Lectures on diseases of the spinal cord. London, The New Sydenham Society, 1895, p 103). Other scientists then have described the symptoms of the disease and they have hypothesized about its pathogenesis, but effective medical treatments appeared only in 1990 (Compston et al, 2002).

MS is one of the most common non-traumatic neurological disorders in younger adults and affects more women than men. Approximately 2 million people worldwide have been diagnosed with MS (Atlas of Multiple Sclerosis, 2008). The epidemiological and clinical importance of MS lies in the significant disability and morbidity attributed to the disease. Not only is the condition relatively common, it is costly with an estimated economic burden exceeding \$6 billion annually in the United States alone (Whetten-Goldstein K et al, 1998).

Although the precise etiology of MS is largely unknown, epidemiological studies point at an important role in both genetic and environmental factors that seem to act synergistically increasing an individual's risk of developing the disease (Disanto G et al, 2012).

Today MS is considered an autoimmune disease due to direct response against a 'trigger' event basing on clinical and laboratory data. Trigger event may be a ubiquitous pathogen that causes the recognition of self-antigens, located likely at myelin level, by autoreactive T cells escaped negative selection process in thymus. What is the trigger event is not yet clear. The average time that elapses between the illness onset and death is about 30 years resulting in a reduction of life expectancy of at least 5-10 years (Bronnum - Hasen et al , 2004).

1.1 Symptoms

In most patients clinical manifestations are related to an impairment of motor and sensory autonomic system, but many symptoms can occur, such as sensory disturbance, lack of coordination and visual problems (Steinman, 2001). Demyelination can explain common features of MS. Oligodendrocyte, a principal target of immune attack in multiple sclerosis, synthesises and maintains the myelin sheath. Myelin is a membrane, spiraled around axons to form the insulating segmented sheath needed for saltatory axonal conduction. In MS, myelin and oligodendrocytes are damaged leading to the formation of 'sclerotic plaque' (or lesion from which the name of the disease originates) particularly in the white matter of the brain and spinal cord (Clanet M et al, 2008) (Fig.1.2). This damage disrupts the ability of parts of the nervous system to communicate, resulting in a wide range of signs and symptoms (Compston A et al 2002 and Murray ED et al 2012). Clinical symptoms often correlate with invasion of inflammatory cells across the blood-brain barrier (BBB) with resulting demyelination and edema (Hafler DA et al, 2004).

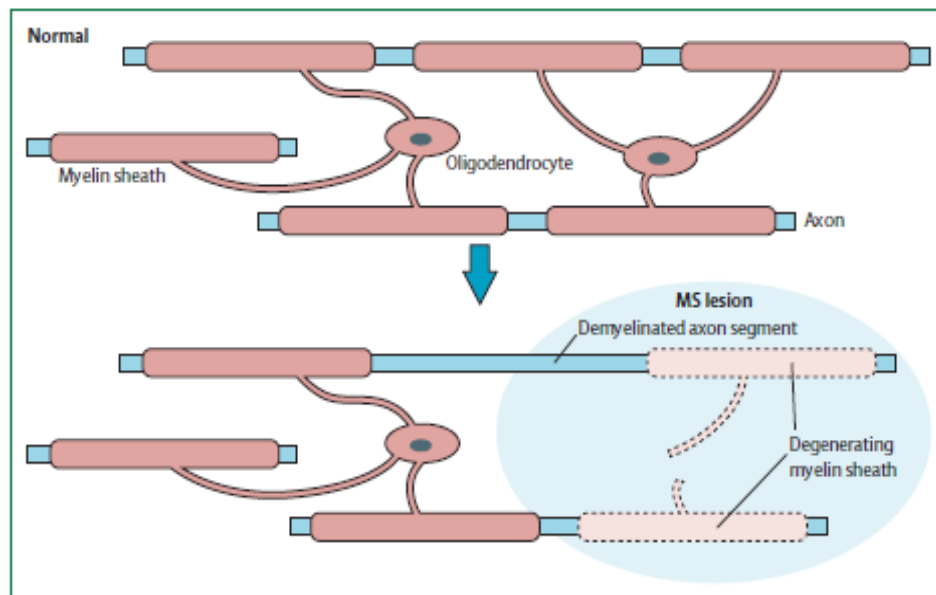

Fig. 1.1 Tissue damaged in MS. In a healthy individual myelin forms an insulating and supporting sheath around the nerve fibre. MS causes the body's immune system to attack the myelin, thus disrupting or breaking the connective between brain and muscle (Rice M et al, 2013).

Neurological symptoms reflect location of the lesions within CNS: for example if patients show visual loss, it is likely to be a lesion in the optic nerve, or for ataxia a lesion in the cerebellum. However many lesions cannot be related to clinical symptoms or others are clinically silent (Compston, 2008). Uhthoff's phenomenon, a failure in conduction with a rise of temperature, and Lhermitte's sign, an electrical sensation down the spin after neck's flexion, are particularly characteristic of MS.

In the later stages of MS physical and psychological symptoms develop, for example weakness, fatigue, chronic pain and tremor. Difficulties thinking and emotional problems such as depression or unstable mood are also common. Fatigue can be very disabling: during physical and cognitive tasks, MS patients tire and take longer to recover.

1.2 Diagnosis

MS is typically diagnosed based on the presenting signs and symptoms, in combination with supporting laboratory and radiological investigations (Tsang BK et al 2011). It can be difficult to confirm, especially early on, since the signs and symptoms may be similar to other medical problems (Trojano M et al, 2001). According to several guidelines termed McDonald criteria and their revision in 2005 (Polman, 2005), diagnosis of MS is made when there are two or more distinct attacks and two or more inflammatory plaques in myelinated regions of the CNS. Diagnosis of MS is also confirmed by detection of brain and spinal cord lesions with magnetic resonance imaging (MRI) and by cerebrospinal fluid (CSF) analysis. MRI is one of the most useful investigational techniques for MS diagnosis: it shows focal or confluent abnormalities in white matter or anatomical dissemination of lesions during time (Keegan, 2002). MRI is used to visualize internal structures thanks to nuclear magnetic resonance. An image can be constructed on the basis of several parameters, such as the longitudinal relaxation time (T1) and the transverse relaxation time (T2). T2-lesions evidence edema and inflammation (in white) and they reflect the burden of tissue damage in brain and spinal cord. T1-lesions (black holes) instead show brain atrophy and severe MS lesions, such as axonal loss and demyelination. Active plaques, which have going inflammation, could be identified by using a contrast agent, gadolinium, a chemical agent able to cross the BBB. This agent tends to settle in regions rich of water and, since the brain lesions contain water, there is higher concentration of it in these. Gadolinium influences the realignment time of magnetization vector of water protons, resulting in brighter MRI images. Although this technique is not specific for this pathology, it enables the CNS damage and spinal cord injury to be revealed as hyperintense areas. With an MRI it is possible to observe that the plaques are mainly located in the white matter of the

semi-oval centre and cerebellar peduncles. Changes in MRI are indicative of BBB disruption and CNS inflammation. Nevertheless MRI correlates relatively with clinical disability (Miller DH et al 1998 and Fu Y et al, 2008).

Another useful technique to confirm MS diagnosis is CSF analysis. A MS hallmark is the presence of oligoclonal bands (OCBs) after electrophoresis of cerebrospinal fluid immunoglobulins. OCB presence is found in nearly 90% of patients so it is a helpful tool for diagnosis but it is not yet clear whether it could be a suitable biomarker for the clinical course (Owens, 1998; Sospedra, 2005; Weber, 2011).

Analysis of B cells from CNS lesions and CSF show a clonal expansion and signs of hypermutation, suggesting their activation and maturation within CNS. Hence, although the importance of antibodies in pathogenesis or progression of certain MS subtypes is recognized, their specificity is still unknown. These antibodies might be directed against component of myelin sheath such as myelin basic protein (MBP) and myelin oligodendrocyte glycoprotein (MOG), but also against infectious agents or oligodendrocyte precursors. The nervous system in MS may respond less actively to stimulation of the optic nerve and sensory nerves due to demyelination of such pathways. These brain responses can be examined using visual and sensory evoked potentials (Gronseth GS et al, 2000).

1.3 Clinical course

The progression of the disease is variable and slightly predictable making treatment complex (Barten, 2010). However four typical clinical forms of MS have been described: relapsing-remitting multiple sclerosis (RRMS), secondary-progressive multiple sclerosis (SPMS), primary-progressive

multiple sclerosis (PPMS) and progressive-relapsing multiple sclerosis (PRMS) (Steinman, 2002).

RRMS form (80%-85% of MS patients) is characterized by an 'attack' or relapse that lasts a few days or weeks, probably due to the autoimmune reaction, followed by a full recovery and a remission period that lasts months or years. However over time the pathological changes become predominant by widespread microglial activation with extensive and chronic neurodegeneration. Thus the episodes not end with the restoration of the original features leading to the progressive accumulation of disability. Approximately the 20-30% of patients enter in a secondary progressive state (SPMS) after 10 years. In rare cases (15-20% of MS patients) the disease begin directly with primary-progressive form (PPMS): they show progressive axonal degeneration, less inflammation and no clinically evident relapses. A still rare sort (5% of MS patients) is the progressive-relapsing form (PRMS), which is characterized by progressive neurological decline and well defined relapses, later in the disorder.

Some patients can also be diagnosed with clinically isolated syndrome (CIS) when they have the first signs caused by demyelination, such as optical nerve dysfunction and ataxia, but have not yet been diagnosed with multiple sclerosis (Barten et al, 2010).

The prognosis of MS is quite variable. The disability is measured by an Expanded Disability Status Scale (EDSS) ranges between 0 (normal neurological exam) and 10 (death). Usually patients achieved EDSS of 6 in 15 years after diagnosis; EDSS scores < 3 represents mild disability, instead EDSS > 5 is a severe disability. However many factors have to be taken into consideration and can modify the clinical course: for example patients with sensory or visual impairment have more positive prognosis then those with motor damages (Barten et al, 2010).

Furthermore, depending on the basis of different contribution of immune cells, antibodies, myelin loss and oligodendrocyte death, four pathological MS subtypes have been identified.

The first pattern is predominated by T cell and macrophage infiltrations: production of IFN- γ , TNF- α and free radicals is responsible for CNS damage. The second pattern, which is the most common, is mostly driven by autoreactive antibodies, directed against MBP and MOG, and complement cascade. In the third case, loss of oligodendrocytes in distal processes can be seen; these degenerative changes are followed by apoptosis: indeed inflammatory mediators induce an impairment of mitochondrial function such as in hypoxia injury. The fourth pattern is only found in few cases of primary progressive course. It is characterized by primary oligodendrocyte degeneration due to metabolic defects and necrosis, followed by demyelination (Compston et al, 2008). Within a single individual, despite the presence of multiple lesions, the pattern tends to be the same (Costantino et al, 2008).

Heterogeneity in morphological alterations of the brain and in clinical course can be observed among different patients: indeed different areas of CNS can be damaged and patients can respond to the treatment in different ways. These differences are likely to be related to features, such as genetic predisposition, that leads to alterations of the immune system, different susceptibility of CNS tissue to inflammation damage or different ability to repair injury (Sospedra et al, 2005).

1.4 Causes

Although the exact etiology of MS remains unknown, genetical and environmental factors play an important role.

1.4.1 Genetics

Even though MS is not an hereditary disease, its incidence in the population is 0,1 %; siblings of MS patients have a lifetime risk of 3% that rises to 25% in twins (Korn et al , 2008). In addition these rates can change depending on gender and age, clustering of MS in families and certain ethnic groups. Results from twin studies suggest a genetic predisposition (Barten et al, 2010; Hoppenbrouwers et al, 2011).

Many genetic variants have been shown to increase the risk of developing MS. Data are strongest for some susceptibility genes on chromosome 6p21 in the area of major histocompatibility complex (MHC) class II and the corresponding genes of this haplotype DRB1*1501 encoding HLA-DR2b, DRB5*0101 encoding HLA-DR2a, DQA1*0102, DQB2*0602 encoding HLA-DQ6 (Ballerini C et al, 2004 and Hoppenbrouwers et al, 2011). How MSC II confers risk for MS is not clear. It has been postulated that MS-associated human leukocytes antigen (HLA) DQ or DR preferentially bind and present specific sets of self antigens such as myelin associated proteins, leading to activation of autoreactive T cells. Otherwise expression of MS-associated DQ and DR could be elevated in CNS, leading to an enhanced antigen presentation (Sospedra et al, 2005)

Some loci in HLA class I region also seem to increase susceptibility to MS, in particular the one involved in EBV-recognition (Hoppenbrouwers et al, 2011). Others such as HLAC5 and the genotype DRB1*11 have been seen to confer protection. IL7R is expressed on B and T lymphocytes and it is essential for the survival of the lymphocytes and immune homeostasis. Indeed other SNPs increase susceptibility to MS as well as other autoimmune diseases, suggesting that probably common pathways are involved (Hoppenbrouwers et al, 2011). Additional candidate genes are PRKCE, BCL2, TYK2 (Baranzini SE et al June 2011).

Further analysis is also conducted on adhesion molecules, immune receptors, cytokines, chemokines and structural genes encoding myelin to try to find new genes or SNPs that confer susceptibility to MS.

1.4.2 Environmental factors

Evidence of the role of environment as a cause of MS includes the non uniform worldwide disease distribution, migration effect and a possible geographic clustering (Lincoln JA and Cook SD 2009). There are many factors that have been considered, but the primary cause is thought to be found in childhood infection followed by a latent interval of years (Erbes GC et al 2008). However there are data which support the "hygiene hypothesis", whereby individuals not exposed to infections early in life, because of clean environment, make aberrant responses to infections when encountering these challenges as young adults. Examples of diseases which are likely to have a role in MS susceptibility if occurring later in life include poliomyelitis, infectious mononucleosis and measles. Infectious agents in particular *Epstein-Barr virus (EBV)*, *herpes simplex virus (HSV)* and *Chlamydia pneumonia (Cpn)* trigger relapses although they are not necessary condition for the disease. Anti-EBV antibodies are elevated in MS patients and, after relapses, these patients often reactivate latent EBV infections (Wandinger et al, 2000). HSV have been long investigated since their neurotropism and tendency to produce latent infections; indeed they have been detected in astrocytes in MS plaques; however DNA and serological data are controversial. Nevertheless data attesting the relationship between intracellular bacteria and MS are contradictory. Thus MS is likely to be induced or exacerbated by common pathogens but, since little or no direct evidence exists, further studies are still required (Wandinger et al, 2000).

So far it is hypothesized that infectious agents exacerbate MS either directly, because of damage in astrocytes and neurons and the subsequent immune response against the released autoantigens, or indirectly activating immune cells (Sospedra et al, 2006). The possible explanation of the role of infectious agents in MS arises from molecular mimicry and bystander activation, including epitope spreading and superantigenic activation of T cells (Fujinami et al, 2006). Studies investigating the pathological changes suggest that high proportion of B cells, accumulated in MS chronic lesions are infected with EBV.

The occurrence of the disorder positively correlates with distance north or south from the equator: those living beyond the 40-degree mark north or south of the equator are more likely to develop MS than those living in the warmer climates near the equator (Alonso A et al, 2008). This is especially true for people in North America, Europe and southern Australia, while Asia continues to have low incidence. There is also evidence that Caucasian people are far more likely than afro-americans to develop disease (Dyment DA et al 2004). The occurrence is strongly correlated to latitude and an important environmental trigger seems to be low sunlight exposition, vitamin D deficiency, diet, cigarettes and toxin (Ascherio et al, 2007 and Marrie RA et al 2004). Several works showed that insufficient ultraviolet radiation or vitamin D, or both, may influence the development of MS because they can attenuate T helper cell type 1 mediated immune responses through several mechanisms (Fig. 1.4.2). Higher sun exposure during childhood and early adolescence and greater actinic damage are associated with a reduced risk of multiple sclerosis (McMichael AJ et al 1997 and Pierrot-Deseilligny C et al 2013).

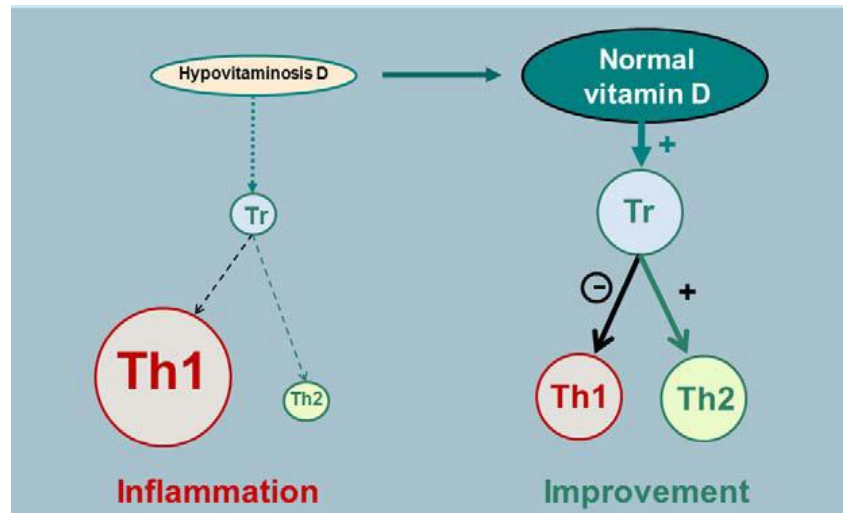

Fig. 1.4.2 Schematic representation of one of the hypothetical immunomodulatory effects of vitamin D. Tr, regulatory T lymphocyte; Th1, lymphocyte T helper 1 ('aggressive'); Th2, lymphocyte T helper 2. (Pierrot-Deseilligny, 2013).

1.5 Pathogenesis

Studies on experimental autoimmune encephalomyelitis (EAE), the animal model of MS, suggest that MS may be an immune-mediated disease. It is thought that autoreactive T cells begin an autoimmune response involving myelin cells of the CNS. Major myelin basic protein (MBP), proteolytic protein (PLP) and myelin oligodendrocyte glycoprotein (MOG) may be the "targets" of these reactions. Th1 and Th17 cells migrate to the CNS upon activation in the periphery. As a result of this migration demyelination and axonal damage begins (Gandhi et al, 2010). Long term effects involving CNS damage are instead likely to be mediated by autoantibodies, activated CD8⁺ T cells, complement cascade and other factors secreted by innate immune response (Sospedra et al, 2005). T CD8⁺ cells are present in damaged areas and may have regulatory activity in the progression of the disease. T CD8⁺ cells suppress the proliferation of Th CD4⁺ by secreting perforin and cytotoxic cytokine. T CD8⁺ cells kill

glial cells leaving exposed axons. B cells are involved in the pathogenesis of MS. In addition to antibodies production, B cells produce pro-inflammatory (TNF and lymphotoxin) and anti-inflammatory (IL-10 produced by naive T cells) cytokines (Duddy et al, 2007).

1.6 Treatment

Since the description of MS by French neurologist Jean-Martin Charcot as a triad of symptoms (nystagmus, intention tremor, and slurred speech) in 1868, research on the etiology, pathophysiology, and management of this disease has progressed dramatically, although a conclusive diagnostic marker or curative therapy still remains undefined.

The goal of mainstay therapies of MS is to reduce relapses and postpone progression of disability in patients (Freedman MS et al 2013). To this end, strategies adopted to treat MS are twofold: a short-term treatment to help reduce the accumulation of disease burden after an acute relapse, and a long-term, sustained treatment aimed at stabilizing the disease process (Spain RI et al 2009). In the initial stages of an MS relapse, individuals are generally treated with high doses (500–1,000 mg) of intravenous corticosteroids (eg, methylprednisolone) for a short period of 3–5 days. In rare cases, subcutaneous or intramuscular injections of adrenocorticotrophic hormone are used, specifically for individuals who cannot tolerate or have poor response to intravenous prednisolone (Berkovich R et al, 2013). These anti-inflammatory agents accelerate the process of recovery, and reduce duration of the relapse; however, they do not have any bearing on the occurrence of new relapses or on long-term disease progression (Myhr KM et al, 2009).

The fundamental pathogenesis of MS is characterized by two stages of disease development (Lassmann H. 2013). The inception of MS symptoms

(clinical and paraclinical) and focal demyelination of neurons occur during the early inflammatory phase. The late neurodegenerative phase is characterized by further demyelination of neurons perpetrated by infiltrating macrophages, microglial cells, and lymphocytes that attack the endogenous myelin sheath proteins as antigens, leading to irreversible axonal loss (Bø L et al 2013). Given the role played by lymphocytes in advancing MS, long-term disease management is largely directed towards suppressing the immune-inflammatory responses that promote demyelination and neuronal degradation in an effort to prevent any saltatory changes in the status quo of patients (Crayton H et al 2004). Outcomes of MS treatments are evaluated based on a reduction in MS annualized relapse rate (ARR), stabilization, or regression in Expanded Disability Status Scale (EDSS) score, and unchanged brain and spinal cord MRI lesion burden (Spain RI et al 2009). Over the past decade, the disease-fighting armamentarium for MS has rapidly expanded with the discovery of new disease-modifying therapeutics (DMTs), which employ different mechanisms to slow or reverse inflammatory lesion formation. To date, regulatory agencies, such as the US Food and Drug Administration (FDA) and the European Medicines Agency, have approved nine different DMTs to aid with modifying the disease course in MS patients. Emerging evidence suggests some DMTs may be able to stabilize and perhaps even improve neurological status; however, they are not capable of completely relieving all symptoms of MS (Freedman et al 2013).

With the introduction of humanized monoclonal antibodies (mAbs) and small specific molecules, ablation of distinct immune populations, or selective blockade/activation of immune molecules have become possible. Some mAbs have been proposed to suppress immune activity in a specific way. For example Alemtuzumab is a mAb targeting CD52, a highly expressed protein on monocytes, CD4⁺ and CD8⁺ T cells. It promotes complement and cell-mediated lyses of targets, hence it is used to reduce some immune cell subsets, shifting the lymphocyte profile:

patients who use it show reduction of inflammatory activity and decreased CNS lesions (Compston et al, 2008). Some therapies interfere with cell migration, by blockade of adhesion molecules and preventing leukocyte binding to the vessel wall and eventually to the blood-brain barrier:

-Natalizumab is a mAb against α 4-integrin recently used as monotherapy in severe cases of RRMS. It interferes with T cell entrance in the brain, suppressing inflammation and relapse rates (Barten et al, 2010). Further studies are needed because it has been associated with development of opportunistic infections, mainly progressive multifocal leukoencephalopathy (PML): this is a rare demyelinating neurological disorder caused by the reactivation of JC polyoma virus (Buck et al, 2011).

As already mentioned, patients with primary or secondary progressive course are less sensitive to the immunomodulatory and immunosuppressive current treatment: in these patients neurodegenerative component is more likely to be treated. So far several approaches have been assessed, such as targeting axonal ionic imbalances or strategies to improve mitochondrial functions, although further studies are still needed (Stadelmann et al, 2011). New directions for therapy of MS include the use of altered peptide ligands, inhibition of Th1 cytokines, and DNA vaccination as reviewed by Minagar A (2013).

2 STEM CELL THERAPY IN MULTIPLE SCLEROSIS

Immunomodulatory (IFN- β and Glatiramer Acetate) or immunosuppressive (Mitoxantrone) treatments exhibit efficacy in relapse-remitting multiple sclerosis or during the early stages of secondary-progressive course. Despite this, not all patients are responsive in the same way and these current therapies are unfortunately almost useless when neurodegenerative processes happen and CNS tissue has been extensively damaged (Muraro et al, 2004; Mancardi et al, 2008). Hence, new therapies should act to inhibit the autoimmune response to prevent CNS damage, by immunomodulation and re-establishment of self tolerance, as well as to promote neuroprotection and remyelination: stem cells have been thought as feasible tools for these aims (Martino et al, 2010; Uccelli et al, 2011). Stem cell therapies are increasingly applied for autoimmune neurological diseases: so far HSC, neural precursor cells and MSC transplantation have been the most investigated.

2.1 Haematopoietic stem cell transplantation

Autologous haematopoietic stem cell transplantation (AHSCT) has been considered as a new therapeutic strategy in aggressive MS forms that are refractory to the conventional treatments. The rationale relies on the eradication of the self reactive immune cells by intense immunosuppression and the achievement of a full immune reconstitution

upon the engraftment of autologous HSCs (Muraro et al, 2004; Saccardi et al, 2006; Mancardi et al, 2008).

The results of the prospective studies show that after a follow up period of 3 years, a median of 70-75% of the treated cases do not progress (progression free survival, evaluated with the EDSS score), the frequency of relapse decreases and inflammation is almost suppressed. These are remarkable results, considering that this population of patients generally worsened despite the conventional performed therapy.

Oligoclonal bands are instead maintained. Nevertheless reduction of inflammation cannot avoid axonal and oligodendroglial degeneration: for those patients with too advanced disability, progression continues. The efficacy of these therapies depends also on the conditioning regimen, the stage of the disease, as well as the inflammatory amount and the CNS damage. Hence, if AHSCT is applied in the early stage of the disease and before it reaches significant accumulation of disability, it may lead to long-term stabilization (Muraro et al, 2004; Mancardi et al, 2008; Uccelli et al, 2010).

Moreover, treatment with AHSCT is associated with profound and long-lasting qualitative immunological changes, suggesting that beyond its immunosuppressive potential, AHSCT could have some beneficial effects also through the reconstitution of the immune system while avoiding the development of the autoimmune process: this 'resetting' of immune system could re-establish self-antigens tolerance (Mancardi et al, 2008).

2.2 Neural stem/precursor cells

Adult neural stem cells/ progenitors or precursor cells (usually defined as NPCs) are a heterogeneous population of multipotent cells with the ability to differentiate toward neuroectodermal lineages (Gage et al,

2000). They secrete neurotrophic factors that exhibit neuroprotective effects, indirectly supporting remyelination in EAE models (Pluchino et al, 2003). Among NPCs oligodendrocyte precursor cells (OPCs) are the most studied: once intratechally injected they can engraft in demyelinated areas and secrete immunomodulatory and trophic cytokines. Nevertheless a direct promotion of endogenous remyelination as well as a re-establishment of a functional neural network are difficult to reach so far (Karussis et al, 2008; Martino et al, 2010).

2.3 Mesenchymal stem cells

2.3.1 Definition

The International Society for Cellular Therapy (ISCT) has proposed a set of standards to define MSCs. Mesenchymal stem cells, or MSCs, are an heterogeneous subset of stromal progenitors of mesodermal, multipotent cells with the capacity of "self-renewal".

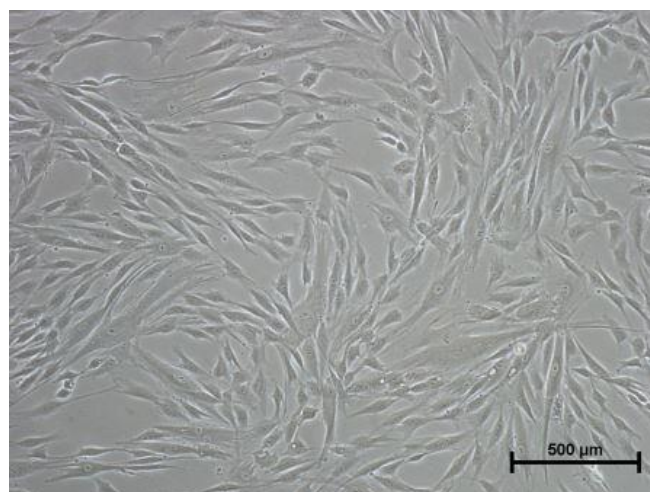

Fig. 2.3.1 Human bone marrow MSCs 4 days from seeding on culture plates (Kassem M et al 2004)

MSCs originally derive from bone marrow. They can also be isolated from many other tissues such as adipose tissue, fetal tissue, umbilical cord blood and many others. MSCs grow as adherent cells on plastic support and express stromal but not hemopoietic markers. MSCs are able to differentiate in vitro and in vivo into cells of the mesodermal lineage (Table 2.3.1).

Table 2.3.1. Minimal criteria for defining multipotent MSCs: the International Society for Cellular Therapy position statement (Dominici M et al, 2006).

Surface markers	Differentiation potential	Other characteristics
CD73+	Osteogenic	Adherence to plastic
CD90+	Adipogenic	Spindle-shape morphology
CD105+	Chondrogenic	
CD34-		
CD45-		
CD11b-		
CD14-		
CD19-		
CD79α-		
HLA-DR-		

2.3.2 History

About 130 years ago, the German pathologist Cohnheim proposed the existence of non-hematopoietic stem cells in the bone marrow. He suggested that these cells could contribute to wound healing as they can be a source of fibroblasts (Prockop DJ et al 1997). Later, Friedenstein et colleagues (1970) identified human adult mesenchymal stem cells when observing a group of cells that developed into fibroblastic colony forming cells (CFU-F). Friedenstein provided strong evidence for the self-renewal potential of stem cells by demonstrating their ability to

regenerate bone tissue. These findings have been confirmed and expanded by many further laboratory studies which have shown that the cells isolated by Friedenstein can also be found in human bone marrow and could differentiate into a range of different mesenchymal lineage cells including chondrocytes, adipocytes, myoblasts and osteoblasts (Bianco P et al, 2008).

2.3.3 Characteristics

Morphology

Mesenchymal stem cells are characterized morphologically by a small cell body with a few cell processes that are long and thin. The cell body contains a large, round nucleus with a prominent nucleolus, which is surrounded by finely dispersed chromatin particles, giving the nucleus a clear appearance. The remainder of the cell body contains a small amount of Golgi apparatus, rough endoplasmic reticulum, mitochondria, and polyribosomes. The cells, which are long and thin, are widely dispersed and the adjacent extracellular matrix is populated by a few reticular fibrils but is devoid of the other types of collagen fibrils (Netter et al 1987).

Function

The physiological role of MSCs is elusive because of their low frequency in tissues and lack of specific surface markers for identification. In the last few years, several studies have demonstrated the in vivo characteristics of MSCs. Data from the works of Sacchetti (2007) and Crisan (2008) revealed that MSCs are likely linked to CD146- CD45- perivascular pericytes, which are capable of producing angiopoietin- 1, an important molecule in HSC microenvironment. Additionally, MSCs have also been

identified as nestin- cells in bone marrow, which play a critical role in constructing the HSC microenvironment (Me´ndez-Ferrer S et al 2010). The physiological role of nestin- MSCs is to support the 'hematopoiesis, to regulate HSCs homing and to play a key role in immunosuppression regulating cell proliferation in the bone marrow niche and into the blood stream (Fig. 2.3.3). MSCs produce cytokines and growth factors, such as IL-6, IL-7, IL-8, IL-11, IL-12, IL-14, IL-15, granulocyte colony stimulating factor (G-CSF) and granulocyte-macrophage colony stimulating factor (GM-CSF): these cytokines are mainly implicated in supporting HSCs and promoting hematopoiesis (Deans et al, 2000; Wilson et al, 2006; Dazzi, 2006). MSCs also express cytokine receptors IL-1R, IL-3R, IL-4R, IL-6R and IL-7R; cytokine induced MSCs express high levels of leukocyte chemokines, such as CXCL9, CXCL10 and CXCL11: these cytokines and chemokines mostly regulate proliferation and differentiation of other cellular types (Honczarenko, 2006; Liotta, 2008).

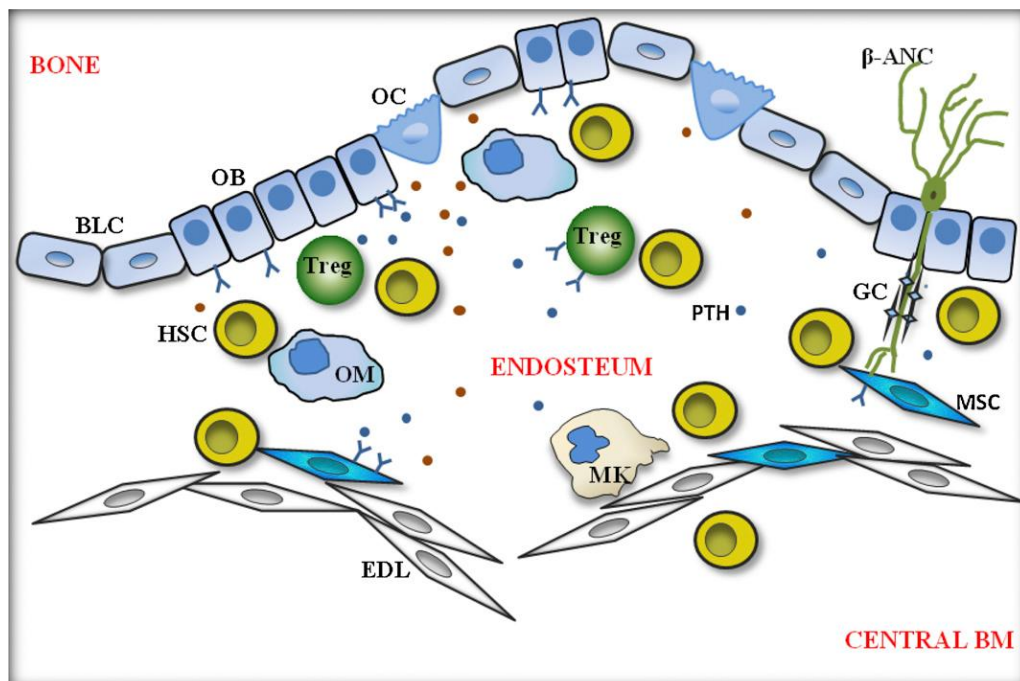

Fig. 2.3.3 Schematic of osteoblastic niche in bone marrow. Osteoblastic niche locates in trabecular region of bone marrow. Active osteoblats (OB), bone-lining

Chapter 2: Stem cell therapy in multiple sclerosis

cells (BLC), and osteoclasts (OC) constitutively line its bony boundary. Hematopoietic stem cell (HSC)–mesenchymal stem cell (MSC) pairings share common niches. Hierarchical regulators from immune, humoral, and neural systems are engaged in the osteoblastic niche and are represented by FoxP3 regulatory T (Treg), parathyroid hormone (PTH), and adrenergic nerve cell (ANC) with ensheathing glial cells (GC) respectively. Abbreviations: MK, megakaryocytes; OM, endosteal macrophages; EDL, endothelium; PPR, PTH/PTHrP receptor; brown dot=Ca²⁺; blue dot=PTH; PPR.

MSCs also express functional Toll-like receptor (TLRs) proteins, such as TLR3 that binds double-stranded RNA, and TLR4 that binds lipopolysaccharide (LPS) of Gram negative-bacteria (Cho et al, 2006; Pevsner-Fischer et al, 2007). They induce NF- κ B translocation and production of cytokines, such as IL-6, or chemokines such as CXCL10 and IL-8; moreover they have been demonstrated to regulate MSCs proliferation and differentiation in vitro (Pevsner-Fischer et al, 2007; Uccelli et al, 2008).

MSCs can migrate toward inflammatory or injured site in response to several chemokines, cytokines and growth factors released in local microenvironment during inflammatory or hypoxic conditions: this is due to the expression of chemokine receptors CCR1, CCR4, CCR7, CCR10 and membrane adhesion molecules that interact with those expressed by endothelial cells (Honczarenko et al, 2006; Croitoru-Lamoury et al, 2007; Martino et al, 2010). In inflammatory conditions cytokines such as TGF- β , TNF- α and IL-1 β , induce MSCs to secrete metalloproteases that help them to cross basement membrane to reach the target tissue (Uccelli A et al 2007). Homing of MSCs to bone marrow as well as migration toward ischemic tissues is mostly driven by SDF-1 interacting with CXCR4 on MSC surface (Petit et al, 2002; Tyndall et al, 2009).

2.3.4 Immunomodulatory properties

It has been demonstrated that MSCs possess in vitro and in vivo immunomodulatory and immunosuppressive properties affecting cells of the innate as well as acquired immune system (Hao L et al, 2012). It has been demonstrated that MSCs modulate activation, proliferation and function of both effector and regulatory T-cell: MSCs inhibit proliferation and cytokine production of activated CD4⁺ T cells and of memory T-cells and suppress the formation of cytotoxic CD8⁺ T cells (Krampera, 2003). The mechanism of immunomodulation is not completely understood. MSCs immunosuppressive action can be mediated by cell-cell contact mechanisms (Batten, 2006) and by the secretion of soluble factors, such as IFN- γ , IL-1 α and β , TGF- β 1, IL-6, IL-10, prostaglandin E2 (PGE2), hepatocytes growth factor (HGF), TNF- α , nitric oxide, indoleamine 2,3-dioxygenase (IDO), but also haem-oxygenase-1 and soluble HLA-G5 (Zappia et al, 2005).

The interaction between MSCs and B cells is still controversial and it seems dependent on MSC concentration. High doses of MSCs inhibit B cells proliferation, migration and secretion of antibodies, without inducing apoptosis with the same mechanism observed for T cells (Tabera et al, 2008). Moreover T cell suppression would compromise the helper function of these cells and consequently impair B cell activation and maturation. MSCs have been found to inhibit B cells differentiation and rescue them from apoptosis. Recently MSCs have also been found to promote survival and antibody secretion (Krampera et al, 2006). These different findings are maybe due to various experimental conditions: thus the situation needs to be further elucidated (Bernardo et al, 2009).

The immunomodulatory effect involves also antigen presenting cells (APC). MSCs impair in vitro differentiation of blood monocytes and CD34⁺ cells into dendritic cells (DCs), suppressing the ability of DCs to stimulate T-

cell proliferation, and shifting cytokine production toward a tolerogenic phenotype (Ramasamy et al, 2007). In vitro experiments indicate that suppressive effects on DCs differentiation are mediated by MSC soluble factors (Djouad et al, 2007). Cell to cell contact seem to play a crucial role in mediating MSC effect on DCs function and it has been recently demonstrated that MSCs are able to shift from immunogenic to tolerogenic DCs, through contact induced cytoskeleton modifications (Aldinucci et al, 2010).

Studies about MSC effect on NK cells are still controversial, although most agree that MSCs mediate NK suppression by different mechanisms: proliferation and cytokine production of NK cells result suppressed via soluble factors (such as IDO, PGE2 and TGF- β). Inhibition of NK-cell cytotoxicity instead requires cell-cell contact (Sotiropoulou, 2006). However MSCs result susceptible to cytokine-activated NK-mediated lysis in vitro (Spaggiari et al, 2006).

Neutrophils are another important cell type of innate immunity that, in course of bacterial infections, are rapidly mobilized and activated to kill microorganisms. After binding to bacterial products, neutrophils undergo a process known as respiratory burst. MSCs dampen respiratory burst and delay the spontaneous apoptosis of resting and activated neutrophils, through the secretion of IL-6, without affecting their expression of adhesion molecules or chemotaxis. By secreting PGE2 and cell-cell contact mechanisms, MSCs can induce macrophages to adopt an anti-inflammatory phenotype and to secrete IL-10 (Uccelli et al, 2008).

2.3.5 Preclinical studies

A remarkable property of MSCs is their powerful capacity for regulating immune responses. As a result, current MSC-based therapy has mainly

been applied to alleviating immune disorders. Various studies have evaluated the therapeutic effect of MSCs in preclinical animal models and demonstrated great clinical potential as reviewed by Ren and colleagues (2012). Regarding MS, in acute and chronic experimental autoimmune encephalomyelitis (EAE), the animal model of the disease, intravenous (IV) MSC administration led to a significant amelioration of disease, inhibition of demyelination, and preservation of axons (Zappia et al 2005). In EAE induced by peptides of myelin oligodendrocyte glycoprotein (MOG₃₅₋₅₅) treatment with human BM-derived MSCs reduced the relative frequency of interferon-gamma (IFN γ)-producing splenocytes, while the relative frequency of interleukin-4 (IL-4) producing cells was increased, suggesting that MSCs reduce inflammatory myelin-specific Th1 cells and increase inflammatory inhibiting Th2 cells (Bai et al 2009). Following in vitro MOG₃₅₋₅₅ stimulation of splenocytes, the levels of Th1/Th17 inflammatory cytokines (IFN γ , IL-17, IL-2, IL-12p70, and TNF α) were significantly reduced, while the levels of anti-inflammatory Th2 cytokines (IL-4 and IL-5) were significantly increased. These studies suggest that the clinical and pathological benefit appeared to be mediated by inhibition of peripheral encephalitogenic T-cells. However, several lines of evidence from animal studies suggest the beneficial effects of MSCs in EAE also may reflect a more direct influence of MSCs on neural cell responses to inflammatory CNS injury. It was thought that with appropriate stimuli MSCs may be capable of differentiating into non-mesodermal lineages including neural cells (Jiang et al 2002). However, in studies using labeled MSCs, little evidence was found for the transplanted cells assuming neural fate (Zappia et al 2005; Gerdoni et al 2007). A more likely possibility is that MSCs provide soluble factors that support development of intrinsic neural cells (Rivera et al 2006). Zhang and colleagues demonstrated that intravenous administration of human MSCs could improve the clinical course of PLP-induced EAE in SJL mice through some level of engraftment in the CNS and subsequent release of

neurotrophic factors promoting oligodendrogenesis (Zhang et al 2005). A recent study also implicated HGF as being functionally important in mediating MSC benefit in EAE (Bai et al 2012) suggesting that MSCs promote intrinsic repair mechanisms rather than differentiating into and directly replacing cellular components. Interestingly, despite a limited ability to engraft in the nervous system, MSCs can clearly modulate the immune response not only in the peripheral lymphoid organs (Zappia et al 2009) but also within the CNS (Morando et al 2012). These results paved the road for the utilization of MSCs for the treatment of MS.

2.3.6 Clinical application

The encouraging scenario arising from preclinical studies supports the use of MSCs in clinical settings. In particular the observation that bone-marrow-derived MSCs suppressed T-cell proliferation in vitro (Di Nicola et al 2002) and in vivo (Bartholomew et al 2002), drove attention to their use for the treatment of immune-mediated diseases. Initial work identified MSCs as a powerful regulator of graft-versus-host disease (GVHD) (Lazarus et al 2005), in which a phase II clinical trial demonstrated that MSC administration was safe and effective (Le Blanc et al 2008). More recently they are emerging as a promising approach for several neurological disorders, including stroke (Yoo et al 2008), spinal cord injury (Jung et al 2009), multiple sclerosis (Bai et al 2009) and other demyelinating diseases (Tanaka et al 2008).

The published experience in MS is modest, but several preliminary studies reported promising results. Recently, Connick and colleagues (2012) showed, in a proof of concept study performed on 10 patients with secondary progressive MS, that intravenous autologous MSCs were safe

and induced physiological improvement in parameters related to visual function, used in the clinical evaluation of patients, suggestive of a protective action. No severe or serious adverse events were reported. Data from an open label study of Bonab (2012) demonstrated that intrathecal administration of MSCs improve and/or stabilize the clinical course of the disease (measured by EDSS and MRI) in progressive MS in the first year after injection. Acute and severe adverse events were extremely rare, and the most frequent complications observed were transient low-grade fever, nausea, weakness in the lower limbs and headache. Despite these positive results, solid data regarding the safety of MSCs in chronic diseases such as MS is still lacking. In the last two years international groups of scientists met in order to establish the safety and efficacy of MSCs in MS. These groups, which include STEMS (Martino et al 2010) and the International MSCT Study Group (Freedman et al 2010) have recently established and published a consensus statements for the establishment of a phase II, international multi-centre clinical trial using MSCs for the treatment of MS. Currently Cohen and colleagues (2013) initiated a phase I trial and parallel mechanistic immunologic studies of autologous, culture-expanded, bone marrow-derived MSC transplantation in MS with the aim to introduce more rigorous research practices, and eventually to create scientific standards that could guide the commercial development of MSC-based therapeutics.

The underlying mechanisms of the therapeutic effects of MSCs are still unknown, but they may involve the following possibilities: 1) transdifferentiation of MSCs into functional integrated mature neurons and/or oligodendrocytes (MSC plasticity); 2) immunoregulatory effect of transplanted MSCs on host-derived immunoreactive cells (immunomodulation); 3) bystander effects of MSCs on the survival of damaged neurons and/or oligodendroglia (neuroprotection); 4) bystander effects of MSCs on the fate and differentiation of endogenous neuronal progenitor cells (NPCs) or oligodendrocyte progenitor cells

(OPCs) present at the lesion site (remyelination) (Fig.2.3.6). The therapeutic effects of MSCs should not be simple actions from themselves but a coordinated process with the local microenvironment. Understanding such interactions will be helpful in choosing an optimal dose and time points for MSC administration and in predicting the range of diseases for which MSCs should be effective (Rivera et al 2012).

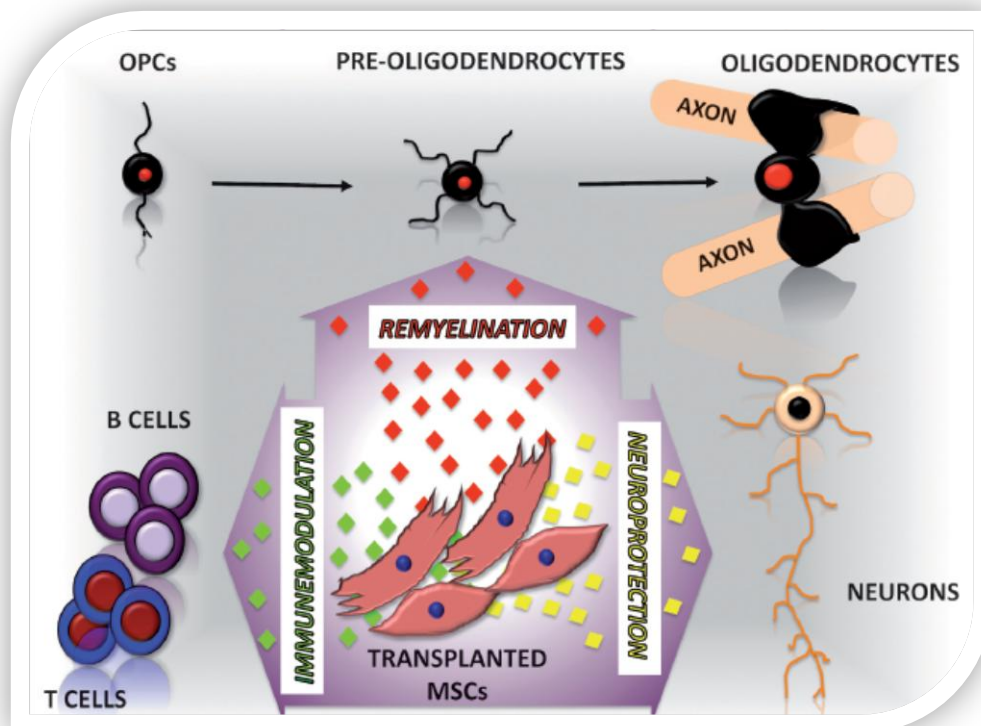

Figure 2.3.6. Therapeutic activities of transplanted MSCs in MS. Bone marrow-derived MSCs are stromal multipotent cells that after transplantation display therapeutic activities for MS treatment. It seems that mainly soluble factors (cytokines, growth factors, neurotrophins, etc) mediate the MSC-induced recovery in MS. Transplanted MSCs can home to and infiltrate the diseased CNS and lymph nodes. After transplantation, MSCs can modulate the immune system inhibiting T and B cell activation (immunomodulatory activity, in green). MSCs protect neurons and oligodendrocytes from cell death (neuroprotection activity, in yellow). MSCs induce oligodendrocyte, stimulate endogenous OPCs (oligodendrocyte progenitor cells) differentiation and maturation that might enhance remyelination in vivo (remyelination activity, in red). (Rivera et al. 2012).

2.3.7 Adverse events

Nevertheless MSC transplantation in humans has been well tolerated, several potential adverse effects should be considered. MSCs infusion could result toxic causing an allergic reaction due to fetal bovine serum in the culture medium or dimethylsulfoxide in the freezing medium (Horwitz EM et al 2002; Chen-Plotkin AS et al 2007). Human platelet lysate seems a valid alternative (Schallmoser K et al 2008). A potential risk of MSC treatment could involve the formation of mesenchymal tissues at ectopic sites. In a rat myocardial infarction model, it has been reported that MSCs may form bone following local injection into the myocardium (Breitbach *et al* 2007). However, in preclinical and in clinical trials so far, no ectopic tissue formation in vivo has been observed (Zappia et al 2005; Gerdoni et al 2007).

A further risk associated with MSCs proliferation in vitro is the acquisition of cytogenetic abnormalities, which occurs after long-term passage in culture (Rubio, D. et al 2005), and subsequent differentiation into tumor cells after in vivo administration (Tolar, J et al 2006), perhaps through a reduction of immune surveillance or a direct effect of cell-cell interactions. Even so concerns that MSCs might transform into tumorigenic cells still exist but it has not been reported to date (Von Bahr L et al 2012).

Recent studies of Darlington and colleagues (2010) confirmed that in vitro MSC inhibit Th1 cell proliferation and production of the Th1 cytokine IFN γ , but at the same time, showed that MSCs stimulate Th17 proliferation and production of IL-17A. In the study of Delarosa (2010) it was reported that MSCs can have an immunosuppressive or pro-inflammatory phenotype depending on stimulation of specific toll-like receptors suggesting that MSCs transplantation could produce autoimmune phenomena.

Chapter 2: Stem cell therapy in multiple sclerosis

There are few studies regarding the fate of transplanted MSCs in vivo. Radiolabelling experiments in rats show localization after intravenous infusion mostly in lungs and secondarily in liver and other organs. Estimated levels of engraftment in these tissues ranged from 0.1 to 2.7%. (Allers et al 2004). Similarly, after infusion in human, MSCs remain in circulation for a very short time, no more than about an hour confirming preclinical studies (Koc ON et al 2000). After human transplantation MSCs have the ability to home from the blood to areas of tissue injury and inflammation, but the mechanisms subtending MSCs distribution and survival are poorly understood, due to the difficult to detect MSCs in human tissues after transplantation (Gao J et al 2001). Long-term engraftment, even if very modest, was demonstrated in a few studies (Horwitz EM et al 1999K; Koc ON et al 2000). In a recent study of Von Bahr and colleagues (2012) it was reported that donor MSCs were detected in only rare tissues among 108 tissues isolated from autopsies of 18 patients who received allogeneic MSCs for complications of hematopoietic stem cell transplantation. No correlation was found between engraftment and clinical outcome suggesting a "hit and run" mechanism of action. At this time, there are no data concerning the duration of putative benefit following MSC transplantation in MS, but it is likely that it will be self-limited and that repeated administration may be required for chronic disorders such as MS. However, repeat administration may increase the risk of sensitization, particularly with allogeneic MSCs as reported in the study of Hare and colleagues (2009). In fact whether transplantation of autologous or allogeneic MSCs is preferable in disorders such as MS is still under discussion. Since MSCs appear to be relatively immunoprivileged allogeneic transplantation appears feasible, allowing transplantation of allogeneic cells without adverse events. However repeated MSC transplantation may be problematic due to the risk of sensitization, rejection, and immunologic memory responses (Hare et al 2009). There is a theoretical concern that autologous MSCs from MS patients could have

Chapter 2: Stem cell therapy in multiple sclerosis

altered properties and therapeutic potential. Conflicting results were reported in studies of MSCs isolated from patients with chronic diseases. Data from the study of Mazzanti and colleagues (2008) reported that MSCs isolated from 10 MS patients had similar proliferation, differentiation capacity, TLR expression, immunomodulatory properties, but significantly higher IP-10 production compared to six healthy controls. In the study of Del Papa and colleagues (2006) it was related that MSCs from patients with connective tissue diseases have altered proliferation and function. Conversely, in the study of Larghero and colleagues (2008), it was reported that MSCs from patients systemic sclerosis have similar phenotypical and functional characteristics as control MSCs, with no effect on disease activity. These conflicting results may be due to the heterogeneity of MSCs populations and different experimental condition used, that can influence MSCs behavior and further studies will be important to address this issue (Klyushnenkova et al 2005). Finally additional studies are required to define the role of host-related factors, including optimal timing of MSC administration, as well as product-related factors, including cell dose and schedule of administration (Lalu MM et al 2012).

3 IP-10

3.1 Chemokines

Chemokines (Greek *-kinos*, movement) represent a large family of structurally and functionally related small proteins (70–120 amino acid residues) within the cytokine family that mediate their biological effects through receptors that belong to the G-protein-coupled receptor (GPCR) superfamily (Gilchrist et al 2010). These chemotactic cytokines act as a chemoattractant to guide the migration of immune cells to locations throughout the body. They have been classified into four subfamilies C, CC, CX3C and CXC according to the presence and number of aminoacids between N-terminal cysteine residues (Vinader et al 2012). C chemokines are lymphocyte attractants and CC chemokines predominantly recruit mononuclear cells with less specificity. CX3C chemokine acts as both a chemoattractant for several cell types and an adhesion molecule. CXC chemokines exhibit chemotactic properties toward neutrophils and lymphocytes, and they also act as positive or negative regulators of angiogenesis (Romagnani P et al, 2004). CXC chemokines can be further divided into two groups (ELR+ and ELR–) according to the presence or absence of a tripeptide glutamic acid–leucine–arginine (ELR) motif that is N-terminal to the first cysteine residue. While ELR+ CXC chemokines are neutrophil chemoattractants with angiogenic properties, ELR– CXC chemokines are lymphocyte chemoattractants with angiostatic properties (Strieter RM et al, 1995). Another classification scheme, based on the function of chemokines and their expression pattern, identifies two classes of chemokines: the inflammatory/inducible chemokines and the homeostatic/constitutive chemokines. Inflammatory chemokines direct the recruitment of effector

leukocytes at sites of inflammation during infection, in tissue injuries and in tumors. The homeostatic group controls lymphocyte and DC trafficking and immune surveillance (Rot A et al, 2004). The finding that several chemokines cannot be assigned unambiguously to either one of the two functional categories led to the characterization of a third group of chemokines, referred to as "dual-function" chemokines (Rot et al, 2004; Luster AD et al, 1995). Dual-function chemokines participate in immune defense functions and also target non-effector leukocytes.

3.2 IP-10 gene

Among chemokine superfamily IP-10, or CXCL10, is an ELR-, dual-function CXC chemokine (Zlotnik A et al 2000). IP-10 was first identified expressed as an early response induced after IFN- γ treatment in a variety of cells and was thus named IFN- γ -inducible peptide (Luster AD et al, 1987 and 1985). The primary translation product of the IP-10 gene, which is located on chromosome 4 in a cluster of chemokine genes, is a 12 kDa protein, containing two internal disulfide cross bridges. Peptidase cleavage leads to the 10 kDa secreted form of this polypeptide, which contains four conserved cysteine residues in the N-terminal region (NH₂-terminus). IP-10 shares the property of being induced by IFN- γ with MIG (CXCL9) and ITAC (CXCL11) (Cole KE et al, 1998). IP-10 is secreted by several cell types, such as leukocytes, monocytes, neutrophils, endothelial cells, keratinocytes, fibroblasts, mesenchymal stem cells, DCs and astrocytes (Luster AD et al, 1997).

3.3 Function

IP-10, as well as CXCL9 and CXCL11, exerts its biological effects by binding to CXCR3, a pertussis toxin (PTX)-sensitive (Kouroumalis A et al, 2005), 7 transmembrane (TM) domain-spanning G protein-coupled receptor (GPCR). IP-10 can act in either a paracrine or an autocrine fashion (Lo BK et al, 2010). CXCR3 is expressed on the surface of a number of immune cell types, including activated T and NK cells, DC, macrophages and B cells (Janatpour MJ et al, 2001; Loetscher AD et al, 1998; Qin S et al, 1998). CXCR3 likely facilitates the movement of lymphocytes within target tissues as shown in Figure 3.3 (Lloyd CM et al. 2000; Sallusto F et al. 1997).

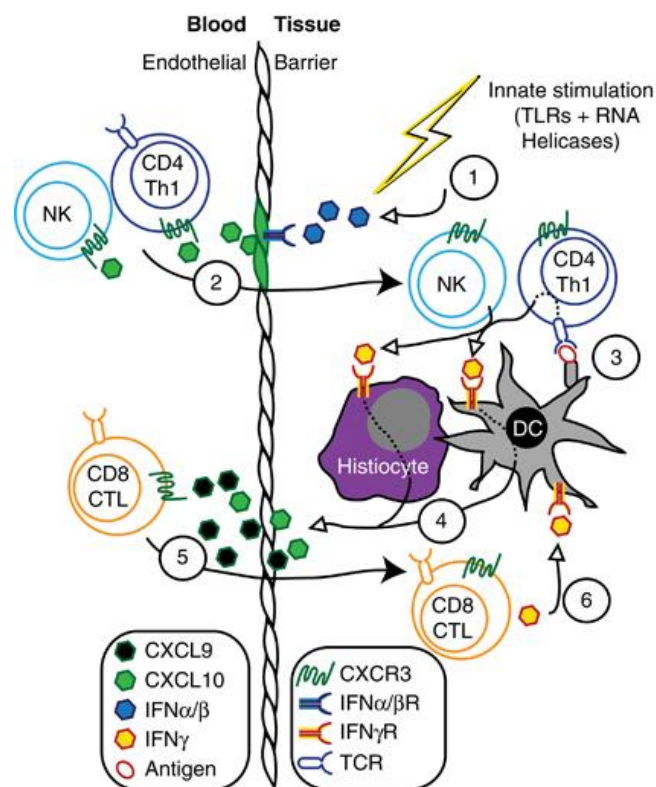

Fig. 3.3 Collaboration between CXCR3 ligands coordinates effector immune responses. This model describes the sequential events from top (1) to bottom (6) involving Type I and Type II interferon induction of the CXCR3 ligands, CXCL9 and CXCL10, and how this defines their respective roles in the recruitment of effector T

cell and NK cell populations into inflamed tissues. CXCL11 also likely contributes to this process but currently less is known how this CXCR3 ligand contributes to this cascade. Open arrowheads indicate cytokine/chemokine secretion and closed arrowheads indicate cellular movement. (1) Innate immune activation, such as bacterial or viral infection, activates TLRs and RNA helicases leading to the release of IFN- α/β and subsequent secretion CXCL10 by tissue resident cells and endothelial cells. (2) CXCL10 recruits NK and CD4⁺ Th1 cells into the target tissue. (3) CD4⁺ cells release IFN- γ in an antigen-specific manner. (4) IFN- γ signaling in tissue resident cells, including DCs and tissue histiocytes induce the production and secretion of CXCL9 and CXCL10. (5) Secreted CXCL9 and CXCL10 recruit CD8⁺ CTLs into the tissue. (6) CTL-derived IFN- γ further stimulate tissue resident cells to produce more CXCL9 and CXCL10, thus, amplifying the Th1-type inflammatory response (Groom J R et al 2013).

This receptor is also expressed on the surface of stromal cells (i.e. endothelial, renal mesangial, trophoblastic cells and keratinocytes) (Janatpour MJ et al, 2001; Loetscher AD et al, 1998; Salcedo R et al, 2000). In these non-immune cells, the CXCR3 signaling pathway induces a number of pleiotropic responses important for organogenesis, angiostasis, tissue repair and remodeling (Rappert A et al, 2004; Belperio JA et al, 2000).

3.4 Clinical relevance

The overexpression of IP-10 has been observed in several neurodegenerative diseases including multiple sclerosis (MS), Parkinson's disease (PD) HIV-associated dementia and Alzheimer's disease (AD) as reviewed by Ramesh and colleagues (2013). Evidence for the involvement of IP-10 in the pathogenesis of MS was first obtained in animal models of MS, including experimental autoimmune encephalomyelitis (EAE). Levels of IP-10 were related to clinical relapses in

mice with EAE (Fife et al., 2001). Astrocytes were identified as the cellular source of IP-10 production in EAE (Ransohoff et al., 1993; Tani et al., 1996). Administration of anti-IP-10 antibodies ameliorated disease activity and reduced accumulation of pathogenic T cells in an adoptive transfer model of EAE, as well as in the chronic demyelinating phase of mouse hepatitis virus infection of the CNS, a viral model of MS (Liu et al., 2001).

Descriptive evidence suggesting a role of IP-10 and CXCR3 in MS has also emerged. IP-10 expression level was spatially associated with demyelination in CNS tissue sections and correlated tightly with CXCR3 expression and continuous accumulation of CXCR3+ T cells in perivascular cuffs in active demyelinating lesions of MS autopsy material suggesting a critical role for IP-10 and CXCR3 in the accumulation of T cells in the CNS of MS patients (Simpson et al., 2000). Circulating CXCR3+ T cells were associated with high production of interferon (IFN)- γ , arguing in favor of the functional significance of these cells (Balashov et al., 1999). Studies on the expression and chemokines release in human neuronal cells of MS patients reported that brain microvascular endothelial cells (HBMECs) and astrocytes produced high levels of IP-10 after inflammatory stimuli (Salmaggi A et al 2002).

Several investigators showed that MS patients exhibited significantly higher IP-10 levels in the cerebral spinal fluid (CSF), compared to control subjects (Franciotta et al., 2001). Data from serial CSF studies by Sørensen's group (2001) showed that IP-10 CSF levels correlated significantly with other markers of intrathecal inflammation such as neopterin, matrix metalloproteinase (MMP)-9 and IgG-synthesis. Furthermore, CSF IP-10 levels did not change after treatment with methylprednisolone, indicating a role for IP-10 in maintaining inflammation in the CNS. Study by Sui and colleagues (2006) showed that IP-10 can mediate neurotoxic effect by elevating extracellular calcium levels. This study provided putative targets for pharmaceutical intervention of neurological disorders associated with IP-10 up-regulation.

There is an association between the levels of IP-10 and the inflammatory/immune processes occurring during organ transplantation (Lazzeri et al 2005). Enhanced IP-10 production either in the graft or in circulating blood of organ recipients is associated with its increased concentration in biological fluids (serum and plasma). Therefore, the detection and quantitation of IP-10 in biological fluids may be a useful tool for monitoring the inflammatory status of organ transplant recipients and for fine-tuning patient therapy (Romagnani et al 2012).

4 Toll-like receptors

Toll-like receptors (TLRs) are a class of proteins that play a key role in the innate immune system (Janeway JR CA, 2002). TLRs together with the Interleukin-1 receptors form a receptor superfamily, known as the "Interleukin-1 Receptor/Toll-Like Receptor Superfamily"; all members of this family have in common a so-called TIR (Toll-IL-1 receptor) domain (Wan T, 2010). TLRs were first discovered in 1985; they received their name from their similarity to the protein coded by the Toll gene identified in *Drosophila melanogaster* by Christiane Nu'sslein-Volhard (Hansson and Edfeldt 2005). The role of TLRs in antimicrobial defense was described in 1996 by Bruno Lemaitre and colleagues (1996), when it was observed that fruit flies lacking the insect homolog of a toll receptor rapidly died from aspergillosis. This phenomenon was explained by the fact that all the extracellular domains of these receptors contain leucine-rich repeats and a cytoplasmic Toll/IL-1R (TIR) domain, which is crucial for TLR downstream signaling (O'Neill and Dinarello 2000), turning it into a critical component of the innate immune system and helping to protect hosts from infectious disease through the recognition of structurally conserved molecules, called pathogen-associated molecular patterns (PAMPs) (Akira S, 2006). The PAMPs recognized by TLRs are diverse, but include molecules expressed by bacteria, fungi, viruses, and protozoa. Mammalian TLRs have been discovered in mice and humans and are reported to be expressed in both myeloid and lymphocytic lineages (Akira and Takeda 2004). TLRs sense microbial products and play an important role in innate immunity. Currently, 11 members of TLRs have been identified in humans, with important functions in innate immunity host defense and early steps of the inflammatory response. TLRs are present in the plasma membrane (TLR1, TLR2, TLR4, TLR5, TLR6 and endosome (TLR3, TLR7, TLR8, TLR9) of leukocytes.

In recent years TLRs were identified also in the mammalian nervous system. Members of the TLR family were detected on glia, neurons and on neural progenitor cells in which they regulate cell-fate decision (Rolls A, 2007). Upon LPS recognition, TLR4 undergoes oligomerization and recruits its downstream adaptors through interactions with the TIR domains. TLR4 signaling has been divided into MyD88-dependent and MyD88-independent pathway. The MyD88-dependent pathway is responsible for proinflammatory cytokine expression, while the MyD88-independent pathway mediates the induction of Type I interferons and interferon-inducible genes (Yong-Chen Lu et al, 2008). Activation of the MyD88-dependent pathway leads to the phosphorylation of MAP kinase (Mitogen-Activated Protein Kinase) and consequently the induction of transcription factor NF- κ B. Notably, NF- κ B and MAPK activation are still induced in the MyD88-independent pathway, although the kinetics of NF- κ B and MAPK activation is slightly delayed (Kawai T et al, 1999). Phosphorylated NF- κ B translocates into the nucleus where it induces the expression of target genes, as IP-10 chemokine, alone or in combination with other families of transcription factors, including AP-1 and STAT -1 (ND Perkins, 2006; Hayden MS, Ghosh S, 2008) **(Fig.4.1)**.

All TLRs have the capacity to initiate inflammation through their ability to induce the production of pro-inflammatory cytokines such as tumor necrosis factor (TNF)- α (Akira and Takeda 2004; Akira et al. 2006; Beutler 2004) and IL-6, thereby regulating their expression (Baeuerle and Henkel 1994). In addition to their role in innate immunity, TLRs activate antigen-presenting cells (APCs) and bridge innate and adaptive immunity by coordinating responses of T cells and B cells (Iwasaki and Medzhitov 2010; Netea et al. 2004). TLRs bind and become activated by different ligands, which in turn are located on different type of organisms and structures, present different adaptors to respond to activation, and are located at the cell surface and internal cell compartment. The significance of individual TLRs in protection against infectious disease has been clearly

demonstrated in murine models and is slowly being demonstrated in primary immunodeficiency patients as they are being recognized and reported in the literature (Picard et al. 2011).

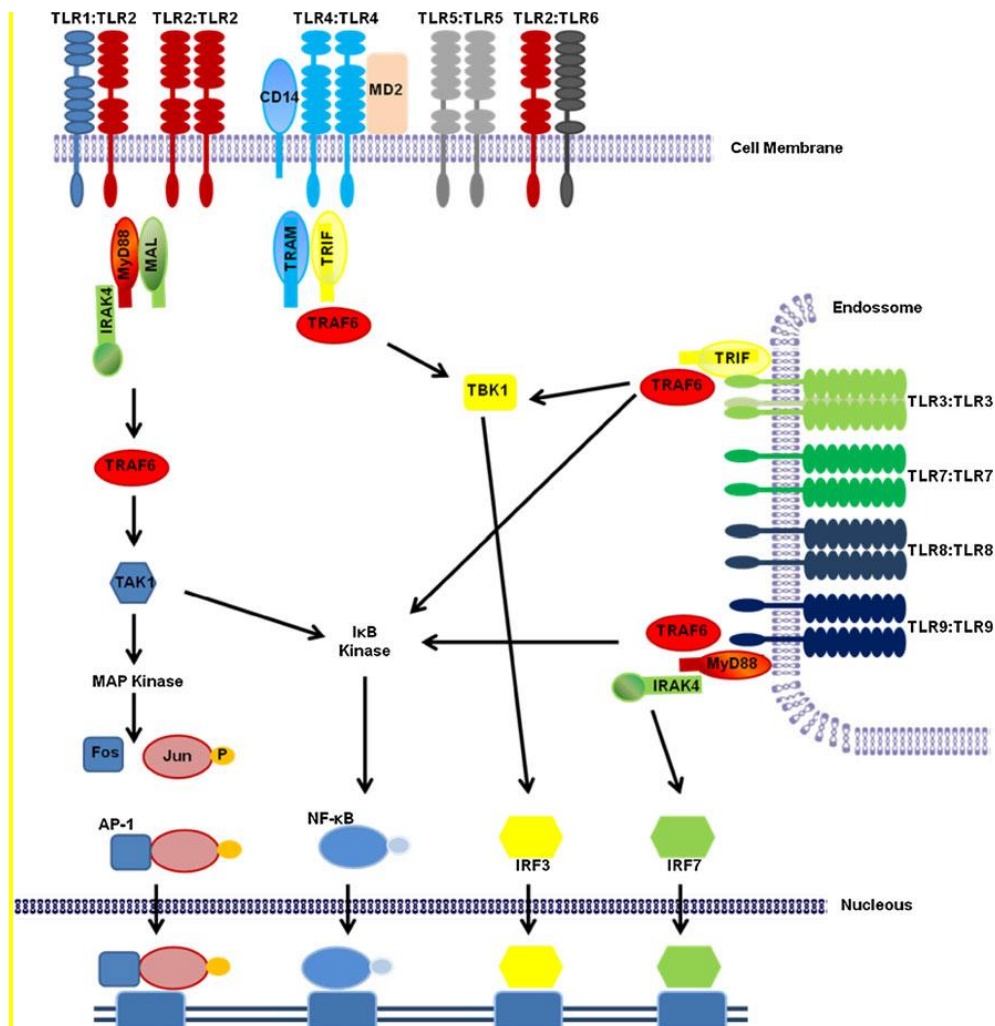

Fig. 4.1 Signaling pathway of Toll-like receptors.

TLR4

Recent studies reveal that cell surface TLRs, especially TLR4, play an essential role in the development of autoimmune diseases and afford multiple therapeutic targets (Sadanaga et al 2007). TLR4 is cell-surface TLR with extracellular recognition domain. Engagement of ligands with TLR4 homodimer induces activation of intracellular “signaling cascades” when the TIR domain is attached by intracellular adaptors (Ciechomska et al

2013). TLR4 is expressed by a wide range of cell types including professional immune cells, for example, monocytes, myeloid DCs, mast cells, as well as T and B lymphocytes, and nonprofessional immune cells like synovial fibroblast-like cells, mesenchymal stem cells and epithelial cells (Huang QQ et al 2009). TLR4 can recognize and bind different ligands, for instance, the exogenous PAMPs like lipopolysaccharide (LPS), taxol, viral glycoproteins, as well as endogenous ligands, such as necrotic cells, heat-shock proteins, HMGB1, fibronectin, extracellular cell matrix (ECM) components, fatty acid, minimally oxidized low-density lipoprotein (mmLDL), and fibrinogen (Richez C, et al 2011).

Bacterial and viral infections are potential cofactors implicated in the initiation and persistence of autoimmune inflammation (Shaw PJ et al 2011). Accordingly, TLRs, an important member of pattern recognition receptors family, are hypothesized to be involved in the pathogenesis of MS. One of the evidence supports this hypothesis is the elevated expressional level of TLR4 in MS patients and rodent experimental autoimmune encephalomyelitis (EAE), an animal model for multiple sclerosis (Andersson A, et al 2008). Another TLR4 ligand, HMGB-1, is evident in active lesions of MS and EAE and functions as a potent proinflammatory signal through interaction with TLR4 (Reynolds JM et al 2012). TLR4 signaling pathway also plays a role in the response to interferon-beta (IFN β) treatment in MS patients. Baseline expression of the interleukin-1 receptor-associated kinase 3 (IRAK3), a negative regulator of TLR4 signaling, has been demonstrated to be significantly decreased in IFN β responders compared with no responders (Li J et al 2013). Thus, inappropriate responses of TLR4 have been testified to be involved in the pathogenesis of multiple sclerosis (Bustamante et al 2011).

TLR4 as well as its ligands, adaptors and downstream kinases, negative regulators, and even microRNAs targeting TLRs could be intervention targets. Small molecules activate or inhibit these targets have been identified and summarized in review by Li J and colleagues (2013).

5 AIM

The aim of this study is a phenotypic and functional characterization of mesenchymal stem cells isolated from bone marrow of severe multiple sclerosis patients, no responsive to conventional therapies and recruited for autologous hematopoietic stem cell transplantation. MSCs were taken both before and after transplant execution. All evaluations conducted on MSCs have been carry out by comparing cells of MS patients with cells of healthy donors, used as controls, with age and sex matched.

Stem cell therapy is increasingly applied as life-saving treatment for advanced patients affected by autoimmune diseases as MS. High dose chemotherapy followed by AHSCT has beneficial effects in poor prognosis MS cases, unresponsive to conventional therapies. Based on their anti-inflammatory and possible neuroprotective properties MSCs, another type of BM stem cells, have recently emerged as promising cellular therapy for the treatment of MS. Preclinical evaluation in EAE, the experimental models of MS, have shown that MSCs are efficacious in suppressing clinical disease (Zhang J et al, 2006; Bai L et al 2012; Morando S et al, 2012). As a logical progression to clinical utility multicentre clinical trials have been launched to assess the safety and efficacy of autologous MSCs transplantation in MS patients and a characterization of MSCs from bone marrow of these patients is crucial (Connik P et al, 2012; Cohen JA et al, 2013).

In this study we investigated cytokines and chemokines implicated in the regulation of the immune system and transplant engraftment focusing on IP-10, a powerful chemokine driving Th1-mediated inflammation (Borgogni E et al 2008). We showed similar inflammatory cytokine and chemokine production from MS and HD group but IP-10 over expression only in MS MSCs confirming data of an our previous work (Mazzanti B et al, 2008). To further understand IP-10 altered production, we investigated

in detail TLR4 signaling pathways in MSCs isolated from 19 MS patients compared to 24 healthy donors. We showed that MS MSCs differ from HD MSCs in the activation of protein kinases directly implicated in TLR4 pathway after LPS stimulation. In the same sample we investigated gene expression by Agilent microarray platform and confirm pathway analysis findings.

In order to understand if the impaired IP-10 production had a correlation with bone marrow environment, we characterized ex vivo bone marrow serum of 7 MS patients. We found that serum contained high amounts of IP-10 suggesting that in vivo MSCs produce IP-10 per se. Interestingly in MS BM serum OPN concentration was high as well and a linear regression analysis showed a significant correlation between IP-10 and OPN production suggesting a possible role of OPN in IP-10 signaling pathway.

IP-10 analysis was repeated in peripheral blood monocytes of the same MS patients. We showed that after LPS direct stimulation MS circulating monocytes produced significantly ($*p<0,05$) higher IP-10 level compared to controls. We confirmed that such chemokine secretion was TLR4 dependent and involved STAT-1, NF κ B and MAPK activation.

We examined the effects of MSCs on peripheral blood lymphocytes with allogeneic dendritic cells during mixed lymphocyte reaction (MLR). As expected, MSCs inhibited T cells response. However, when autologous or allogeneic MSCs were added to T cells stimulated by anti CD3/CD28 antibodies they stimulated T cells proliferation and IFN- γ secretion. These findings underscore the importance of further preclinical work to define MSCs effects on disease relevant immune responses under variable conditions.

Finally we compared BM MSCs and circulating monocytes properties in MS patients before and 2 years after AHST. Our data suggest that the transplant execution doesn't influence MSCs and monocytes properties, and that IP-10 production is a stable characteristic of both cells residing in two different compartment, suggesting that IP-10 is a biomarker of severe

disease. We showed that after transplantation patients had stable clinical condition without disease activity on MRI and without therapeutic need suggesting that IP-10 altered production, even if persisted, did not affect the outcome of therapy.

In this study for the first time we evaluated the effect of AHST on bone marrow and peripheral blood compartment, providing potentially useful information to understand mechanisms of transplant procedure and to detect possible different characteristics between patients and donors bone marrow or peripheral blood cells.

6 MATERIALS AND METHODS

6.1 Patients

19 MS patients, resistant to conventional treatments, were consecutively recruited for autologous hematopoietic stem cell transplantation (AH SCT) programmed by the Hematology Unit, Careggi Hospital (Florence, Italy). All patients were diagnosed with MS according to Poser (1983) and McDonald criteria (2001) responding to the following inclusion criteria:

- Age between 18 and 55 years
- EDSS $\leq 6,5$
- Relapsing Remitting (RR) or Secondary Progressive (SP) MS form, with MRI activity and/or clinical worsening of the disability despite treatment, in the previous 6 months
- Refractory to treatment with monoclonal antibody Natalizumab or impossibility to perform this therapy, due to allergic reaction to the drugs or neutralizing antibody presence.

Immunosuppressive treatments were stopped at least 1 month before the BM collection.

24 BM samples were collected from age and sex matched patients, not affected by congenital pathologies, undergoing orthopedic surgery for the treatment of osteopenic disorders, and used as control, Healthy Donors (HD).

In addition to BM blood samples were collected from 4 MS patients and 4 healthy blood donors (buffy-coat) as control.

6.2 Isolation, culture and characterization BM MSCs

Whole BM was collected from iliac crest, diluted in dextrose citrate acid and centrifuged for 10 min at 700 g; the interface between plasma and the red cell pellet (buffy-coat) was finally recovered. Liquid fraction (BM serum) was collected and frozen whereas cells were then plated in 75 cm² flasks (1.6x10⁵ cells/cm²) in Dulbecco's modified Eagle's medium with low glucose, (DMEM-LG; Gibco, Invitrogen), supplemented with FBS (HyClone) 10% and incubated at 37°C in humidified atmosphere containing 95% air and 5% CO₂. On reaching confluence, the adherent cells were harvested with 0.05% trypsin and 0.02% EDTA and diluted in complete medium (primary culture, P0). Cells were plated again at 10⁴ cells/cm² in 100-mm dishes (P1); expansion of the cells was obtained with successive cycles of trypsinization and reseeding. Cells were plated again at 10⁴ cells/cm² in 100-mm dishes (P1); expansion of the cells was obtained with successive cycles of trypsinization and reseeding.

6.3 Cytokine and chemokines determination on MSCs and BM serum

For 7 MS patients and 7 HD, MSCs were grown to confluence (1x10⁵ cell/well) and activated or not with lipopolysaccharide (LPS 1 µg/ml, Sigma) for 24 h. Supernatants were collected and stored for determination of GM-CSF, OPN, IFN-γ, MMP-9, MIG, IL-1α, IL-1β, IL-2, IL-6, IL-8, IL-10, IL12-p40, IL-12-p70, IL-17, IL-23, TNF-α and IP-10 by ELISA (all performed with Quantikine kit, R&D Systems) or LUMINEX technology,

using MILLIPLEX MAP Cytokine/Chemokine buffer and detection Kit (Millipore).

The same cytokine and chemokine profile was analyzed in ex-vivo bone marrow (BM) serum of 7 MS patients by Luminex technologies.

For 3 MS and 3 HD, MSCs were grown to confluence (1×10^5 cell/well) and activated or not with Zymosan (1 μ g/ml, Sigma) for 24 h; supernatants were collected and stored for IP-10 determination by Luminex technologies.

6.4 IP-10 determination on peripheral blood monocytes

Monocytes were separated from peripheral blood mononuclear cells (PBMC) obtained from peripheral blood of multiple sclerosis patients by gradient centrifugation on Biocoll (BIOSPA) at room temperature. Monocytes were isolated from PBMC using CD14+ Cell Separation kit (Miltenyi Biotec) according to the manufacturer's instructions. CD14 cells was also separated from buffy-coat of healthy donors by the same methods described for patients cells isolation.

For 6 MS and 5 HD, monocytes were plated at a density of 1×10^5 cell/100 μ l/well in 96-well U bottom plate (Nunc) and activated or not with lipopolysaccharide (LPS 1 μ g/ml, Sigma) or interferon-gamma (IFN- γ 10 ng/ml, eBioscience) for 24 h. Supernatants were collected and stored for determination of IP-10 by LUMINEX technology, using MILLIPLEX MAP Cytokine/Chemokine buffer and detection Kit (Millipore).

6.5 Analysis of, IFN- β , IP-10, STAT-1, NF-kB and I κ B gene expression

IFN- β , IP-10, STAT-1, NF-kB and I κ B genes expression was evaluated by Real-time PCR using an ABI PRISM® 7900HT Sequence Detection System (Applied Biosystems). For MS and HD, MSCs were cultured in 24-well plates and mRNA was isolated with Qiazol Reagent (Invitrogen) from 1×10^5 cells for sample. Each mRNA sample was quantified by NanoDrop (Celbio) and cDNA was synthesized from the same template quantity (RETROscript kit, Ambion). All PCR amplifications were performed on MicroAmp optical 96-well reaction plate with Taqman® Universal Master Mix and using Assay on Demand (Applied Biosystems). Each assay was carried out in duplicate and included a no-template sample as negative control. RT-negative samples were used to demonstrate that the signals obtained were RT-dependent. Relative expression of mRNA levels was determined comparing experimental levels to a standard curve generated using serial dilution of cDNA obtained from human PBMCs. β -actin expression levels were used as housekeeping gene for normalization.

6.6 Gene expression profile of MSCs: microarrays analysis

MSCs were plated at a density of 300.000 c/cm² in 25 cm² cell culture flask. RNA was analyzed with the one color microarray by Agilent technologies. For 5 MS and 5 HD, MSCs were washed in cold PBS and mRNA isolated by Qiazol protocol. In brief 5 μ g of total RNA was used to synthesize biotin-labeled cRNA and 10 μ g of fragmented cRNA was

hybridized to GeneChips, stained and scanned with the GeneArray scanner controlled by Agilent technologies software. Hierarchical cluster analysis with normalized gene expression values was performed. Pathways analysis was performed using the KEGG data base, involving genes that regulate immune response, inflammatory response, TLR signaling pathway, MAPk pathway, and NF-kB signaling.

6.7 Signal transduction protein analysis

Phosphorylation level of proteins involved in TLR4 signaling pathway was studied by LUMINEX technology, MILLIPLEX map Immunoassay Kit (Millipore). We analyzed phosphorylation state of ERK-1/2, p38 MAPK, CREB, JNK and STAT-1 in MSC lysates. For 5 MS and 5 HD, MSCs were grown to confluence and 1×10^5 cell/ml were cultured in 24 well plates. The evaluation was conducted in basal conditions and after LPS stimulation (1 μ g/ml) for 30 minutes or 2 hours (respect to proteins analysis).

MSCs were washed with cold PBS and lysed with lysis buffer (Lysis buffer Milliplex MAP, Millipore), containing protease inhibitor cocktail (Sigma). Then the lysates were recovered with the use of a "scraper", transferred into 1.5 ml tubes, placed in ice for 15 minutes and then centrifuged at 1300 rpm for 10 minutes at 4 °C. Supernatants were transferred into new tubes. Each sample was quantified by BCA method (Euroclone), using a spectrophotometer (Victor, Wallac). The proteins extracted were quantified in relation to a standard curve, prepared with serial dilutions of bovine serum albumin (BSA, Sigma) with known concentration.

Multiplex analysis of p-38, MAPK, CREB, JNK, ERK-1/2 and STAT-1, total and phosphorylated protein, was performed with 10 μ g for total protein for

each sample, by MILLIPLEX Map-cell -signaling-MAP-mates kit (Millipore), using Bioplex reader (Biorad). Each value was expressed as ratio between phosphorylated protein and total protein.

6.8 Mixed lymphocyte reaction (MLR)

MLR was performed in 96-well U bottom plate (Nunc). For 3 MS and 3 HD, CD4⁺ T cells (10⁵ cells/well) were cultured 4 days with allogeneic DCs (LPS activated, 10⁴ cells/well) with or without MSCs (10⁴ cells/well; 10² cells/well) in RPMI 10% FCS. At day 5, the proliferative response was measured by [3H]-Thy (37 MBq/ml, Perkin Elmer) incorporation test. [3H]-Thy was added and pulsed the last 8 h. Plates were then harvested (TomtecMacIII) on glass fiber filters (Perkin Elmer) and thymidine uptake was measured by liquid scintillation in a Microbeta 1450 Trimux counter (Wallac).

6.9 Analysis of autologous T cell proliferation and IFN- γ secretion

T lymphocytes were separated from peripheral blood mononuclear cells (PBMC) obtained from peripheral blood of multiple sclerosis patients (4 samples) by gradient centrifugation on Biocoll (BIOSPA) at room temperature. T lymphocytes were isolated from PBMC using anti-CD4⁺ T Cell Separation kit II (Miltenyi Biotec) according to the manufacturer's instructions. CD4 cells were also separated from buffy-coat of healthy

donors (4 samples) by the same methods described for patients cells isolation.

96 well plates U bottom (Nunc) were coated with anti-CD3 and anti-CD28 antibodies (of each 1µg/ml, eBioscience) at room temperature for 2 hours. T cells were plated at the density of 1×10^5 cells/well in absence or presence of MSCs. Two T/MSC ratios, 10:1 and 100:1, were used in all experiments. At day 5, supernatants were collected for IFN- γ determination by Luminex technology. At the same time the proliferative response was measured (as previously described).

6.10 Statistical analysis

Results were expressed as mean \pm standard deviation (SD). Statistical analysis was performed using Student's t test for unpaired samples. Statistical significance was for P-values < 0.05 .

7 RESULTS

7.1 Patients

The present study was conducted on MSCs isolated from bone marrow (BM) of 19 multiple sclerosis patients (MS MSCs), resistant to conventional treatment and recruited for autologous hematopoietic stem cells transplantation (AHSCT). MSCs isolated from bone marrow of 24 healthy donors (HD MSCs) were used as controls.

Patients clinical characteristics are summarized in *Table 7.1*.

In the study 17 women and 2 men were included. The age of disease onset ranged from 19 to 53 years, with a median of 32 years. The disease lasted for 15 years (median), with a range from 2 to 33 years. An expanded disability status scale (EDSS) scored from 2,0 to 6,5. The course of MS was Relapsing Remitting (RR) in 11 patients and Secondly Progressive (SP) in 8 patients. At the age of 46 years (median) patients undergone to AHSCT. All patients received immunomodulatory and/or immunosuppressive therapies before they were subjected to transplantation. Previous treatments were stopped at least 1 month before BM collection.

Table 7.1 Patients characteristics

Patient	Gender	Age/hosp	MS	Disease duration (y)	EDSS	Previous therapy (cronological order)	BM collection
MS1	M	35	RR	20	6	Ster/Aza/Cy/Mtx	Oct 2005
MS2	F	21	RR	10	6,5	Ster/Mtx	Oct2006
MS3	F	27	SP	18	6,5	IFN/Cy	May 2006
MS4	F	24	RR	7	6,5	Nb	Mar 2010
MS5	F	28	RR	9	6,5	Ster/Copaxone/Cy	Feb 2009
MS6	F	34	RR	15	6	IFN/Cy	Aug 2008
MS7	F	19	SP	33	6,5	Ster/Copaxone/IFN/Mtx	Jun 2008
MS8	F	32	SP	14	6,5	Aza/Mtx/Cy	Sept 2009
MS9	F	35	SP	24	4	IFN/MTX/Cy	Oct 2007
MS10	F	36	SP	11	6,5	IFN/Copaxone/Cy	Nov 2012
MS11	F	43	RR	8	6	IFN/Copaxone/Cy	Jun 2011
MS12	F	25	RR	7	6	IFN/Aza/Cy	Sept 2005
MS13	F	30	SP	20	6	IFN/MTX/Cy	Mar 2010
MS14	F	20	RR	7	6	Aza/IFN/Nb/Cy	Jul 2012
MS15	F	21	SP	33	6,5	IFN/Cy/IFN	Jul 2012
MS16	F	34	RR	15	6	Ster/Aza/Mtx/Ter/Nb/CCS/Fum/Fg	Mar 2013
MS17	M	33	RR	2	2	Ster/Plasma exchange	Jun 2013
MS18	M	36	RR	16	3	IFN/Aza/Nb	Jun 2013
MS19	F	53	SP	26	6,5	IFN/Nb/Copaxone/Plasma exchange/Cy	Jul 2013

Aza: Azatioprine; **Ster:** Corticosteroids; **Mtx:** Mitoxantrone; **IFN:** Interferon β ; **Cy:** Cyclophosphamide; **Nb:** Natalizumab; **Ter:** Terifluonemide; **Fum:** Dimethylfumarate; **Fg:** Fingolimod

7.2 Cytokine and chemokine determination on cell supernatant

On the basis of a study conducted in our laboratory (Mazzanti et al 2008) we widened the analysis of cytokines and chemokines implicated in the regulation of the immune system and in transplant engraftment, such as

GM-CSF, OPN, IFN- γ , MMP-9, MIG, IL-1 α , IL-1 β , IL-2, IL-6, IL-8, IL-10, IL12-p40, IL-12-p70, IL-17, IL-23, TNF- α and IP-10. We analyzed the supernatant of 8 MS and 8 HD MSCs after 24 hours LPS stimulation (cell at confluence) by LUMINEX technology, using MILLIPLEX MAP Cytokine/Chemokine buffer and detection Kit (Millipore), this technology allows to test many proteins in a small volume of sample. IL-8, IL-10 and MIG only was determined by ELISA test. MSCs from both HD and MS patients produced high level of IL-6, IL-8 and OPN (for MS: mean value respectively of 8567 pg/ml, 18000 pg/ml, and 1486 pg/ml and for HD: mean value respectively of 6368 pg/ml, 17000 pg/ml and 2600 pg/ml). Both group produced GM-CSF at lower concentration (for MS: mean value of 61 pg/ml and for HD: mean value of 54 pg/ml) (**Fig. 7.2 A**) and didn't produce IFN- γ , MMP-9, MIG, IL-1 α , IL-1 β , IL-2, IL-10, IL12-p40, IL-12-p70, IL-17, IL-23, and TNF- α (data not shown). On the other hand, MS MSCs significantly ($p < 0.026$) differed from HD MSCs in IP-10 production after LPS activation (for MS mean value of 6397 pg/ml and for HD mean value of 583 pg/ml) (**Fig. 7.2 B**). We analyzed IP-10 production in basal condition and we detected that MS and HD MSCs didn't produced the chemokine (data not showed). The production of IP-10 was further investigated by Real Time PCR, conducted on 8 samples of MSCs isolated from patients and 8 control samples (**Fig. 7.2 C**), before and after 4 hours stimulation with LPS. Following stimulation, samples derived from patients showed a significant ($*p < 0,05$) increase of IP-10 expression level compared to HD. On basal condition MS MSCs showed significantly ($*p < 0,05$) higher IP-10 expression level compared to control samples. Real Time PCR confirmed Luminex and ELISA data as we reported in a previous work (Mazzanti et al 2008).

A)

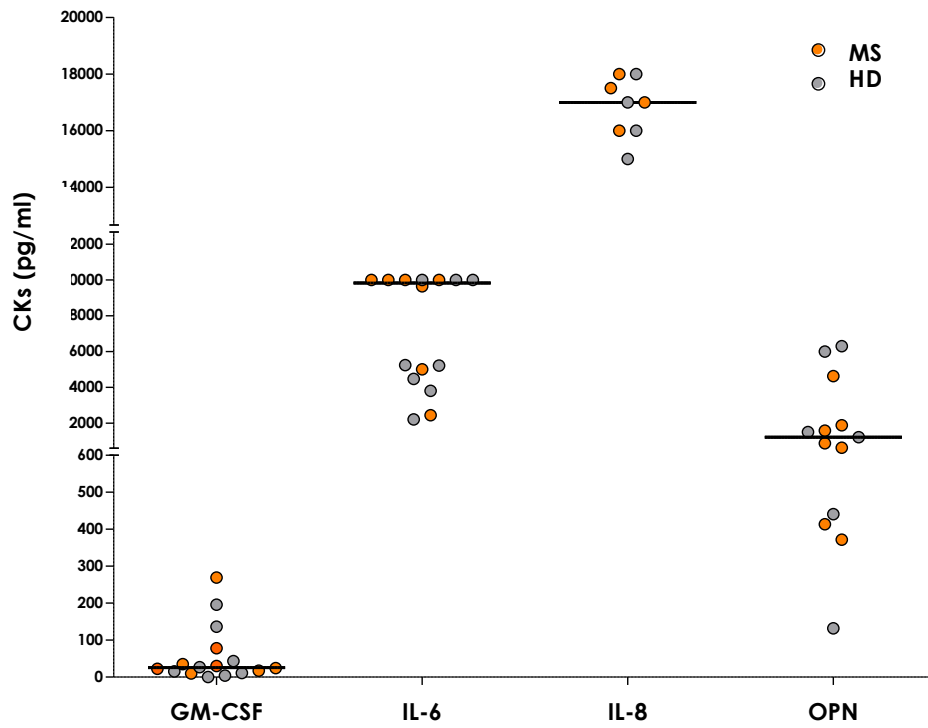

B)

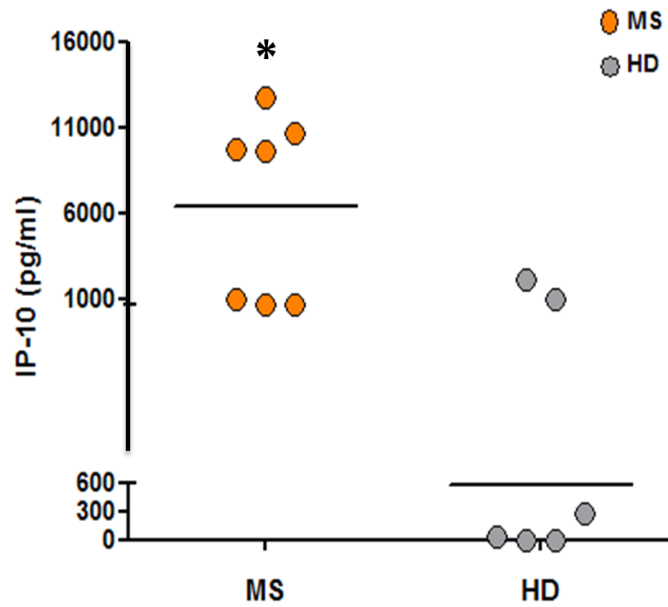

C)

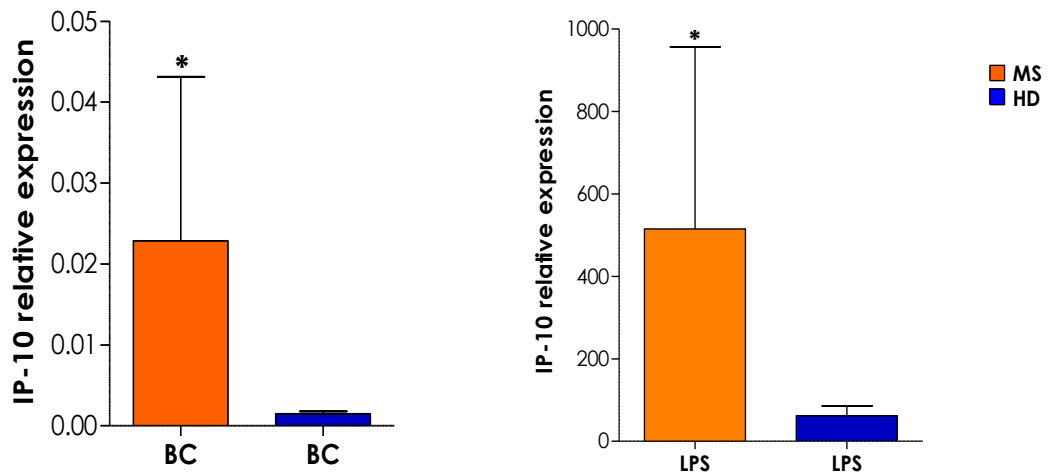

Fig. 7.2 Cytokine production on cell supernatants. A) and B) Cytokines and chemokines production determined by Luminex or ELISA test on cell supernatants of 8 patients (MS) and 8 healthy donors (HD). Cells were LPS activated. Each circle is a single MS/HD sample, the horizontal bars represent mean value of cytokine concentration (pg/ml). **A) Pro-inflammatory cytokines determination.** MS MSCs (orange circles) and HD ones (grey circles) produce GM-CSF, IL-6, IL-8 and OPN at similar extent. **B) IP-10 production,** MS MSCs produce IP-10 significantly more than HD. Analysis was performed by non parametric t-test indicating that that mean is statistically significant in MS MSCs vs HD MSCs under LPS stimulation (* $p < 0.02$). **C) IP-10 relative expression,** by real time PCR. The graph shows mean value \pm SD of 8 MS samples (orange columns) and 8 HD (blue columns) before and after LPS stimulation. Expression is reported as ratio to β -actin. Analysis was performed by non parametric t-test indicating that mean is statistically significant in MS MSCs vs HD MSCs on basal and under stimulated condition (* $p < 0,05$). IP-10 expression level is specifically higher in MS MSCs compared to HD ones when cells were resting or LPS activated. IP-10 up-regulation under LPS stimulation is confirmed.

7.3 IP-10 production at different passages of cell culture

We increased samples number and verified IP-10 production at three different passages (P2, P4 and P6) of culture. The test was performed in resting or LPS activated MS and HD MSCs by ELISA. At all the tested passages, MS MSCs had a significant ($p < 0,0,5$) higher IP-10 production under LPS stimulation (TLR4) compared with HD (at P2, P4, P6 for MS MSCs: mean values \pm SD respectively of 781 (± 232); 1077 (± 387); 1275 (± 294) and for HD: 136 (± 69), 434 (± 133); 303 (± 116) (**Fig. 7.3**). We may conclude that MSCs producing IP-10 maintain this characteristic during in vitro culture.

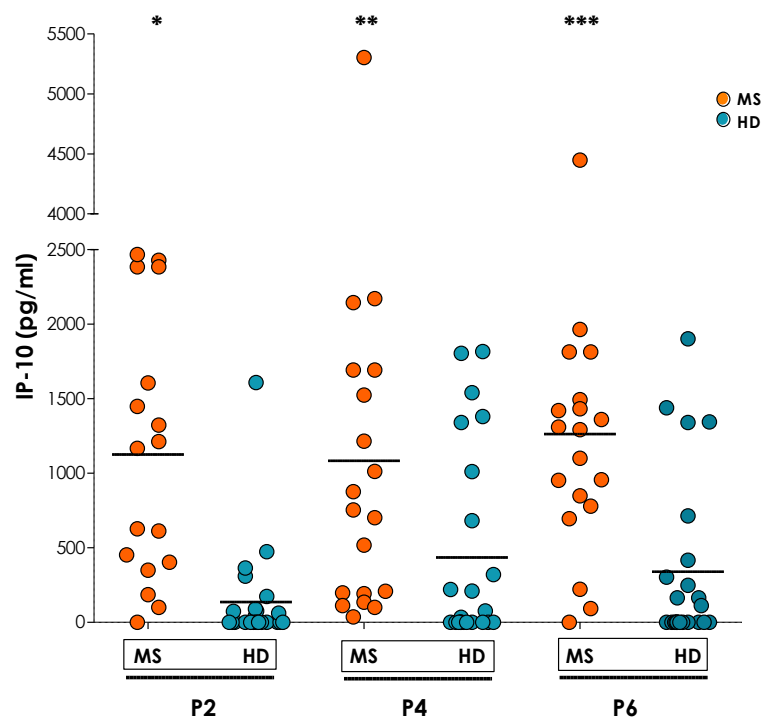

Fig. 7.3 IP-10 production. MSCs from 19 MS patients (orange circles) and 24 HD subjects (blue circles) were analyzed for IP-10 production at three different passages, P2, P4 and P6 by ELISA test. Each point is a MSC independent sample, mean value is represented with horizontal bar. Here we show that MS MSCs produce IP-10, whereas HD do not. Analysis was performed by non parametric t-test indicating that mean is statistically significant in MS MSCs vs HD MSCs at P2

(* $p < 0.002$), MS MSCs vs HD MSCs at P4 (** $p < 0.05$) and in MS MSC vs HD MSCs at P6 (***) $p < 0.0014$).

7.4 Alternative pathways for IP-10 production

We showed that MS MSCs produce IP-10 significantly more than HD cells after stimulation with LPS, a TLR4 ligand. In addition to TLR4, there are many others signaling pathway that lead to transcription of IP-10 gene. The main pathways are represented in **Figure 7.4** (in the figure IP-10 is indicated as CXCL10); we investigated, if IFN- β (IFN-receptor ligand) and Zymosan (TLR2 ligand) could be implicated in IP-10 production.

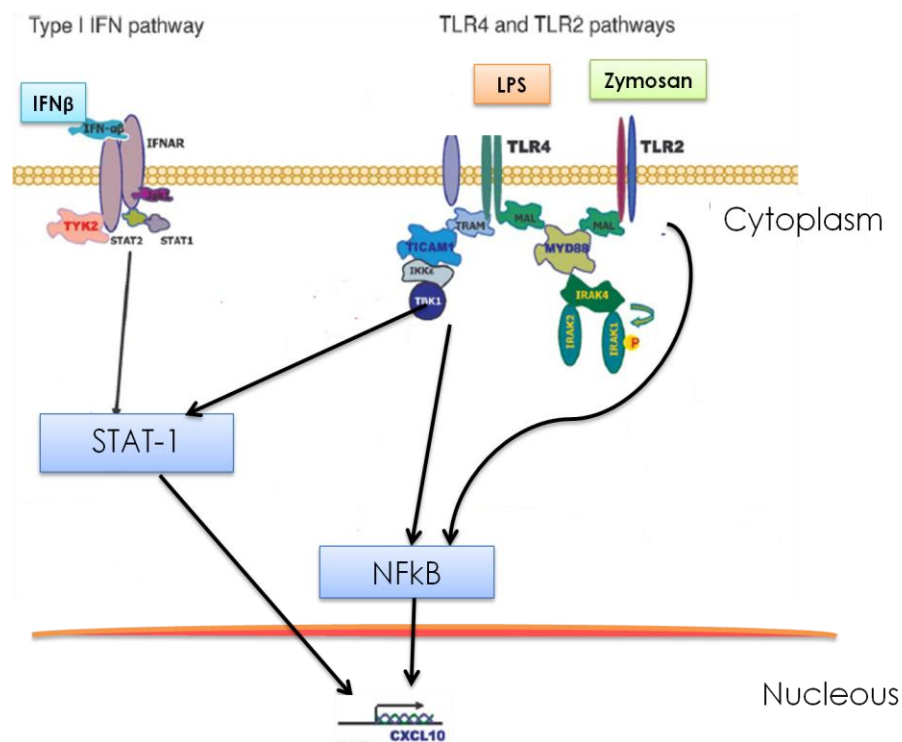

Fig. 7.4 Signaling pathways responsible for IP-10 production: IFN- β pathway: stimulation of IFN- β receptors with the homonymous cytokine leads to the activation of kinases that phosphorylate substrate proteins called STATs. The phosphorylated STAT proteins move to the nucleus, bind specific DNA elements, and direct

transcription of many genes including IP-10 (Darnell JE et al 2012). TRL2 and TLR4: upon ligation to their specific ligand (respectively Zymosan for TLR2 and LPS for TLR4), TLRs trigger serial signal transduction pathways leading to activation of MAPKs, NF- κ B and/or STAT1. These activated transcriptional factors translocate to the nucleus and induce the expression of their target genes such as IP-10 (Kawai T et al 2011). (**IFN**, interferon); (**TLR**, toll like receptor); (**STATs**, signal transducers and activators of transcription); (**MAPks**, mitogen-activated protein kinases); (**NF- κ B**, nuclear factor- κ B).

7.4.1 IFN- β

IFN- α / β may induce IP-10 production, together with other chemokines. In fact, the stimulation of human fibroblasts or endothelial cells with IFN- α , IFN- β or IFN- γ in combination with TNF- α resulted in a synergistic induction of IP-10 (P. Proost et al. 2006) and these results have been confirmed by other studies (B. Beutler, 2004 and S. Akira et al. 2004). To check if increased IP-10 was due to upstream increased IFN- β production, we measured IFN- β in cell supernatants by mean of ELISA. Supernatants were from MS and HD MSCs at basal and LPS stimulated conditions, in our experiments we didn't evidenced any production of IFN- β (data not shown). Indeed, this may be due to wrong timing for CK detection in respect to CK production. Therefore, we analyzed IFN- β expression profile by Real Time PCR in 4 MS and 4 HD MSCs at basal condition and after stimulation. We found that IFN- β mRNA expression was increased after LPS stimulation at the same extent in MS and control MSCs (**Fig. 7.4.1**). These data suggest that IFN- β is not responsible for the augmented IP-10 production that our results showed.

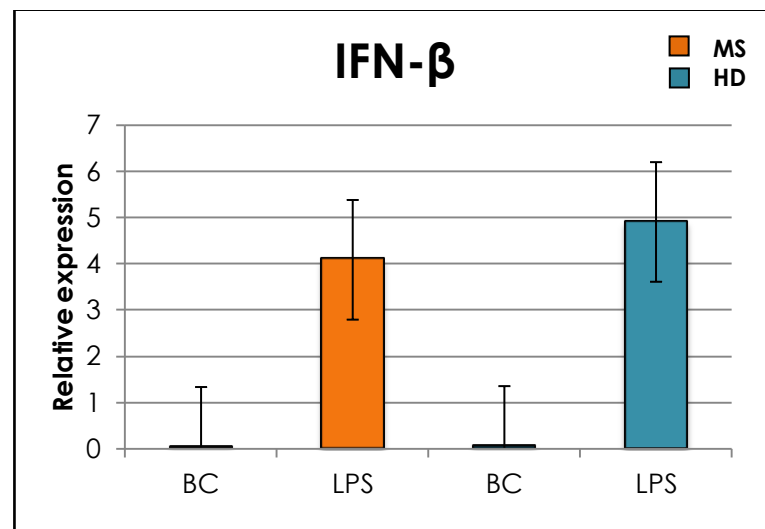

Fig. 7.4.1 IFN- β expression profile. IFN- β expression was tested by real time PCR on 4 patients (MS, orange columns) and 4 HD, (blue ones) on basal condition (BC) and upon stimulation with LPS (LPS) for 4 hours. Expression is reported as ratio to β -actin. IFN- β up-regulation after LPS stimulation, in MS and HD shows no significant differences.

7.4.2 Zymosan

Stimulation of TLR2 with zymosan, a yeast cell wall derivative (Wyllie DH et al 2000), may induce IP-10 production (Kawai T et al 2011). Studies in monocytes and DCs demonstrated that zymosan induces comparable cytokine and chemokine production to LPS (Dowling et al 2008). For that reason we evaluated by ELISA on 4 MS and 4 HD MSC supernatants whether altered IP-10 production may be reproduced by zymosan stimulation. In our experiments we found that zymosan stimulated MS and HD MSCs didn't produce IP-10 (data not shown). These data show that TLR2 signaling pathway is not responsible for increased IP-10 production, suggesting a specific role of TLR4 and not a generic more pronounced innate immune response.

7.5 Signaling proteins expression profile

As INF- β and TLR2 pathways didn't affect altered IP-10 production, we focused our attention on TLR4 pathway analyzing the expression level of STAT-1, NFkB and I κ B transcription factors that direct production of inflammatory cytokines including IP-10. We tested 6 MS and 6 HD MSCs on basal conditions and LPS stimulation (4 hours) by Real-time PCR. Relative expression is shown as ratio to β -actin. In patients, STAT-1, NFkB and I κ B expression levels were respectively 271 (\pm 453), 33 (\pm 3) and 31 (\pm 4) on basal conditions; 613 (\pm 776), 182 (\pm 641) and 258 (\pm 202) after stimulation with LPS. In donors ratio were respectively 110 (\pm 102), 11 (\pm 5) and 10 (\pm 9) on basal conditions; 236 (\pm 239), 66 (\pm 25) and 99 (\pm 111) upon stimulation (**Fig. 7.5 A, B, C**). These data show that STAT-1, NFkB and I κ B genes were up-regulated in the patient group compared with controls, indicating that these down-stream transcription factors correlate with IP-10 production. In particular we noted that STAT-1 relative expression correlated with IP-10 production by MS MSCs upon LPS stimulation (**Fig. 1D**).

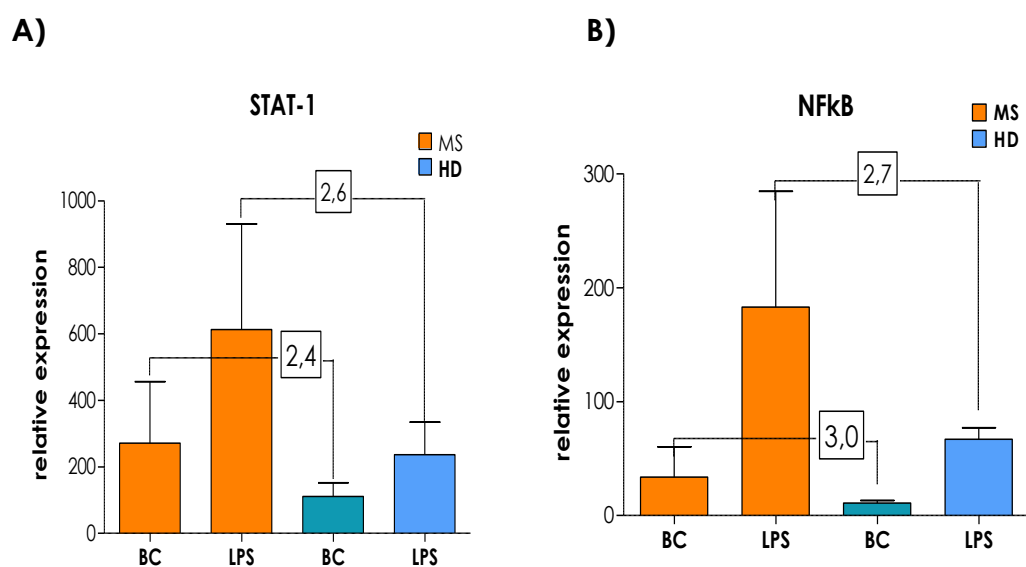

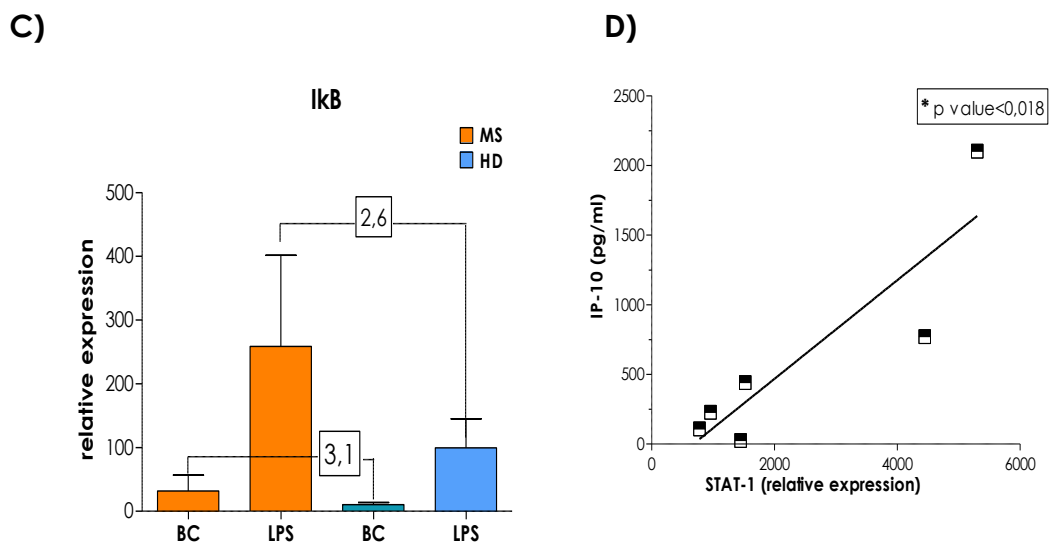

Fig. 7.5 Signaling protein expression profile. A) STAT-1 was tested by real time PCR in MSCs of 6 patients (MS, orange columns) and 6 control (HD, blue ones) on basal condition (BG) and upon LPS stimulation for 4 hours. Expression is reported as ratio to β -actin. Fold change (FC) is reported in graphs and is expressed as ratio between protein relative expression in MS MSCs and protein relative expression in HD ones, respectively on basal and stimulated condition. Here we show that MS MSCs have higher expression level of STAT-1 than HD ones before and after LPS stimulation. **B, C)** At the same time **NF-kB** and **IκB** were tested. NF-kB and IκB are up-regulated in both groups, but in MS group the expression levels of NFKB1 and IκB are higher than HD ones both on basal and upon stimulated condition. **D) Correlation** between IP-10 production (Fig. 7.2.B) and STAT-1 relative expression (this Fig. 7.5.A) in MS patients on stimulated condition. Each point is a MSC independent sample. Analysis was performed by non parametric t-test indicating that linear regression is statistically significant (p -value$0,018$) between IP-10 production and STAT-1 relative expression.

7.6 Transcriptional analysis of TLR4 signaling pathway

In order to investigate the mechanisms underlying the production of IP-10 we expanded the transcriptional analysis performing a whole genome

assay by one-color micro-array technology (Agilent Microarray) on 5 MS MSCs and 5 HD before and after LPS treatment (4 hours). We analyzed the data in three comparisons: A) MS MSCs compared to HD MSCs in absence of stimulus; B) MS MSCs stimulated with LPS compared with unstimulated cells; C) HD MSCs stimulated with LPS compared with unstimulated cells.

To investigate the regulation of pathways and cellular networks in our samples, we performed pathway analysis enrichment on differentially expressed genes (DEGs) applying a Fisher Exact Test over KEGG (data were statistically significant when $p < 0.005$). DEGs analysis identified 1029 down- and 745 up-regulated genes in the comparison A. 433 down- and 694 up-regulated genes in the comparison B (respectively with $FC > 2$ and $FC < 2$, $P \text{ value} < 0.005$). 427 down- and 357 up-regulated genes in the comparison C. When comparing the effect of LPS stimulation in patients MSCs and healthy MSCs against the respective controls, we noticed that 122 DEGs were in common between the two comparisons (B and C). Among those, 38 genes shown identical regulation (i.e., up- or down-regulated in both comparisons). For example, genes such as IL-6 and IL-8 were up-regulated in both groups on stimulated condition, in agreement with ELISA data (**Fig. 7.2.A**). On the other hand, 84 genes were regulated in opposite directions, that is up-regulated in one comparison but down-regulated in the other and vice versa. To note that STAT-1, NFkB and IkB genes were specifically up-regulated in B comparison ($FC=2,13$), but not in C one (data not shown). The up-regulation of STAT-1, NFkB and IkB agreed with RT PCR (**Fig. 7.5.A and B**). Together with STAT-1, NFkB and IkB, MAPK cascade was active in B comparison (**Fig. 7.6**) but not in C one. In particular p-38 gene, the MAPk14 (mitogen-activated protein kinase 14), was up-regulated in B comparison ($FC=2,2$) in agreement with Luminex data (**Fig. 7.7.A**), shown in the next 7.7 paragraph. Together with transcription factors and p-38 genes DUSP6 gene ($FC=2,62$), an ERK specific inhibitor, was exclusively up-regulated in B comparison, possibly explaining that phosphorylated level of ERK didn't increase in MS MSCs

after LPS stimulation (in agreement with Luminex data (7.7 paragraph). MAPKs, STAT-1, NF-kB and DUSP6 genes up-regulation maybe suggest that LPS stimulation activates MAPKs that direct a temporally distinct signaling through STAT-1 or NF-kB in MS MSCs.

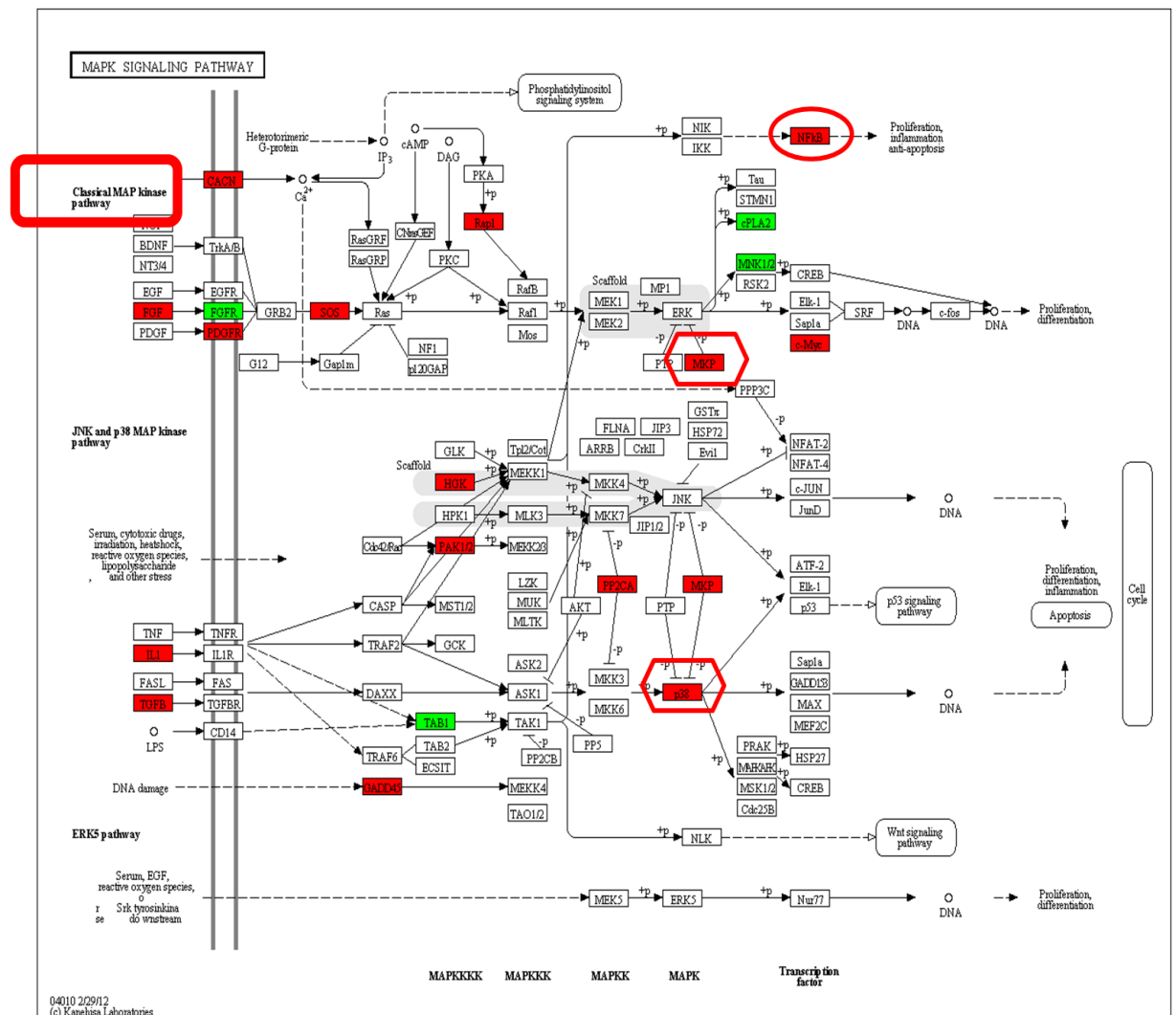

Fig. 7.6 MAPKs signaling pathway. Focusing on signaling pathways of interests, we mapped DEGs into KEGG pathways. The graph shows in red and in green genes respectively up- and down-regulated in B comparison, but not in C one. To note that MAPKs, p-38 and NFkB genes (underlined in red) are specifically up-regulated in LPS MS MSCs, B comparison. NF-kB gene up-regulation is confirmed.

7.7 Signal transduction protein analysis

As we have seen that in MS MSCs there is a greater expression level of transcription factors and MAP kinase directly implicated in TLR4 pathway compared to control ones, we analyzed their activation state by Luminex technology. We analyzed the phosphorylation state of p-38, CREB, JNK, ERK and STAT-1. We tested 5 MS MSCs and 5 HD, on basal condition and upon 30 minutes (p-38, CREB, JNK, ERK) or 2 hours (STAT-1) LPS stimulation. MS MSCs expressed higher phosphorylation levels of p-38, CREB and JNK on basal condition (ratio between phosphorylated protein and total protein respectively 0.077, 0.055 and 0.176 ± 0.081) compared with HD MSCs (ratio between protein phosphorylated and total protein of 0.018, 0.022 and $0.093, \pm 0.018$). Phosphorylated proteins level was higher in patients also after LPS stimulation (ratio between phosphorylated protein and total protein 0.189, 0.131 and $0.380, \pm 0.197$) than in controls (ratio between phosphorylated protein and total protein 0.031, 0.021 and $0.166, \pm 0.021$) (**Fig. 7.7 A; B;C**). Phosphorylation state of STAT-1 (**Fig 7.7 D**), equal at basal level (ratio on basal condition of MS and HS MSCs respectively 0.0082 ± 0.011 and 0.0089 ± 0.011), differs after LPS stimulation (0.034 ± 0.023) compared to controls (0.014 ± 0.03). Together with phosphorylation level of p-38, JNK and CREB, higher in MS MSCs respect to HD ones on stimulated condition, phosphorylation at basal condition indicates that signaling proteins implicated into TLR4 pathway were more activated in MS MSCs compared to HD ones. These results are compelling with Real Time and Microarray analysis. P-38, JNK, CREB and STAT-1 could be the signaling factors responsible for IP-10 production in MS MSCs under LPS stimulation. On the other hand MS and HD MSCs showed no change about the phosphorylation level of ERK on basal condition compared to stimulated one (data not shown) in agreement with Microarray data. We suggested that ERK correlated pathway was no activated under LPS

stimulation, supposing that ERK probably isn't implicated in the signaling cascade responsible for IP-10 production.

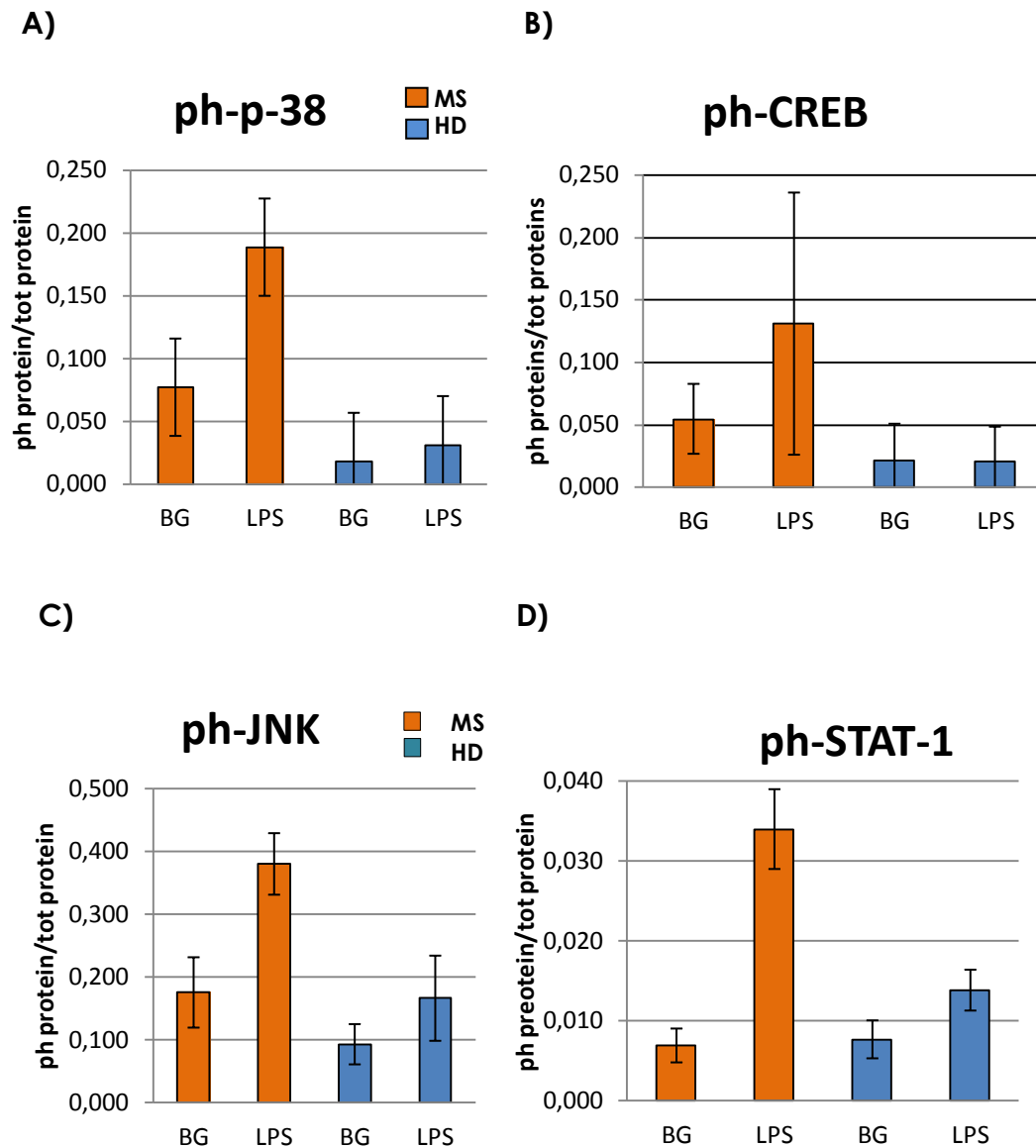

Fig. 7.7 Signal transduction protein analysis. **A, B, C)** The activation state of p-38, CREB, JNK and STAT-1 was investigated by LUMINEX technology in 5 MS MSCs and 5 HD ones, on basal condition (BG) and upon LPS stimulation. The graphs show the ratio between phosphorylated protein and total protein levels (ph protein/tot protein), expressed as mean \pm SD. MS MSCs have higher level of ph p-38, ph CREB and ph JNK than HD ones before and after 30' LPS stimulation. **D)** MS MSCs show

higher level of pSTAT1 than HD ones upon 2 h LPS stimulation, without any variation in BG condition.

7.8 Cytokine and chemokine determination on bone marrow serum

We characterized ex vivo BM serum of 7 MS patients for the presence of pro-inflammatory cytokines and chemokines in order to find a correlation between BM inflammatory environment and MS MSCs. In particular we evaluated cytokines and chemokines profile in BM serum and MSCs derived from the same MS patients. We analyzed GM-CSF, OPN, IFN- γ , MMP-9, IL-1 α , IL-1 β , IL-2, IL-6, IL12-p40, IL-12-p70, IL-17, IL-23, TNF- α and IP-10 production by LUMINEX technology (Millipore). We showed that MS BM serum contained high level of MMP-9, OPN and IP-10 (**Fig. 7.8 A**) (mean value respectively of 2213 pg/ml, 29081 pg/ml and 138 pg/ml). We found a significant correlation between OPN and IP-10 in MS BM serum (p value < 0,05), as assessed by linear regression (**Fig. 7.8 B**). We noticed that BM and MSCs (**Fig. 7.2.A and B**) of MS patients produced OPN and IP-10 at similar extent suggesting a correlation between MSCs environment and IP-10 production. We didn't revealed in BM serum the presence of IFN- γ , GM-CSF, IL-1 α , IL-1 β , IL-2, IL-10, IL12-p40, IL-12p70, IL-17, IL-23, and TNF- α (data not shown).

A)

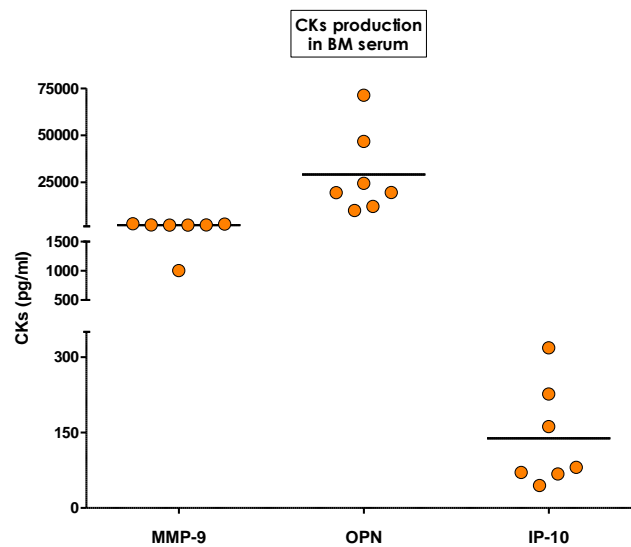

B)

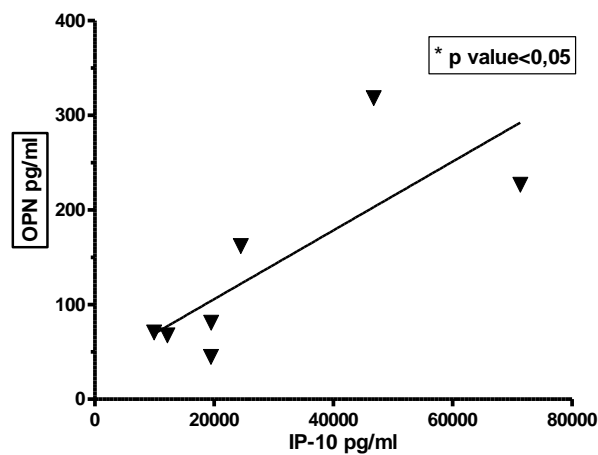
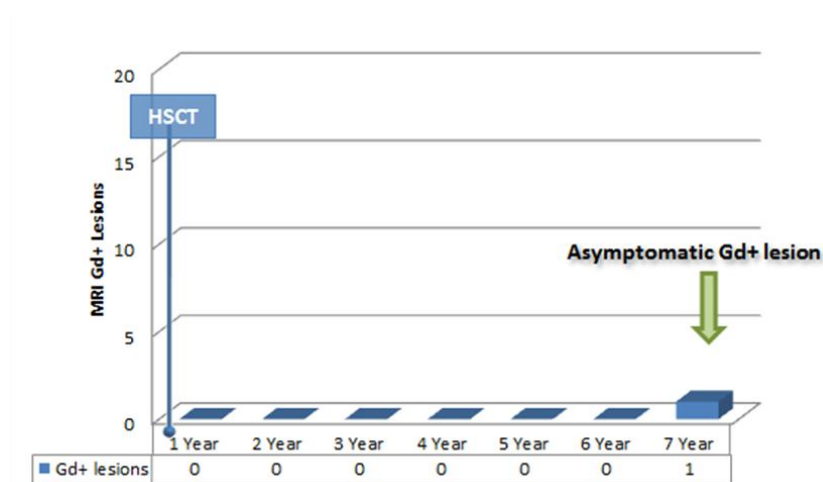

Fig. 7.8 Cytokine production determined in BM serum. BM serum of 7 patients was tested ex vivo by LUMINEX technology. **A) Cytokines and chemokines determination:** in the graph each point is a BM serum independent sample, the horizontal bars represent mean value of cytokine concentration (pg/ml). Here we show that MS MSCs produce high level of MMP-9, OPN and IP-10. **B) Correlation between OPN and IP-10 production,** here we show a significant correlation (p value < 0,05) between OPN and IP-10 in BM serum of MS patients. Analysis was performed by non parametric t-test.

7.9 IP-10 production after AH SCT

After two years from the execution of AH SCT when peripheral immunological full reconstitution has occurred MSCs were isolated from BM (MSCs-post), with the same method used for MSCs isolated before transplantation (MSC-pre). To date, it is reported that 2 years after AH SCT peripheral immunological function is fully recovered and patients have stable clinical condition without disease activity on MRI (in terms of contrast-enhancing areas and/or new lesions on T2) and without therapeutic need (**Fig. 7.9 A, B**) (Saccardi et al 2006).

A)



B)

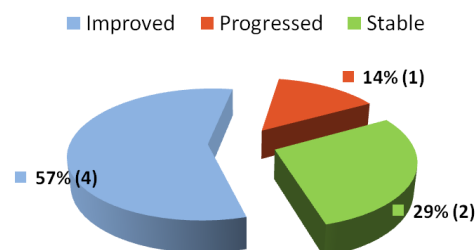

Fig. 7.9 Patients clinical characteristics after autologous hematopoietic stem cells transplantation. A) Cumulative MRI Gd+ enhancing lesions after AH SCT: no MRI activity has been evaluated from +24 months after AH SCT and at the last visit at

Long-term Follow-up. Only one patient showed a new enhanced lesion at 7 years after AHST in absence of clinical relapse or disease progression. **B) Follow-up after AHST:** 2 years after transplantation patients had stable (14%) or improved (57%) clinical condition. Only one patient (14%) showed worsening. (Saccardi et al 2006).

MSCs-post were characterized in terms of function and phenotype with the same methods used before transplantation and they revealed similar characteristics to MSCs-pre (data not shown). In order to elucidate possible effects of AHST on BM compartment, IP-10 production was reanalyzed in MSCs-post. We performed this analysis by mean of ELISA on supernatants of resting or LPS activated cells at three different passages, P2, P4 and P6. We compared IP-10 production under LPS stimulation with the same 4 MS MSCs isolated before and after transplantation. After LPS stimulation MS MSC-pre and MSCs-post produced IP-10 to a similar extent (**Fig. 7.9**). IP-10 production expressed by mean values \pm standard deviation (pg/ml) at P2, P4 and P6 is respectively 1289 (\pm 951); 1061 (\pm 316) and 1187 (\pm 768) for MSCs-post and 896 (\pm 468), 671 (\pm 625) and 1076 (\pm 309) for HD MSCs. In our sample we may conclude that AHST doesn't affect MSCs IP-10 increased production.

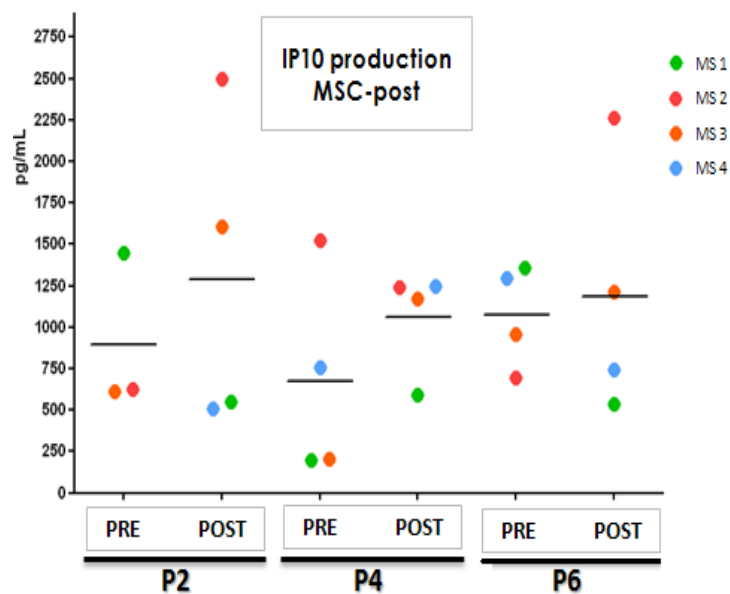

Fig. 7.9 IP-10 production after AHST. IP-10 production was tested in supernatants of LPS activated cells of 4 MS MSCs isolated before and after AHST (MSCs-pre and -

post). The analysis was performed by ELISA. IP-10 production was tested in MSCs from the same 4 patients (MS1, MSCs from patients 1 orange circles; MS2, MSCs from patient 2 pink circles; MS3, MSCs from patient 3 light-blue circles; MS4, MSCs from patient 4, green circles) at three different passages, P2, P4 and P6. Each point is a MSC independent sample, mean value is represented with horizontal bar. MSCs-post produced IP-10 as well as MSCs-pre.

We repeated signaling protein analysis involved in TLR4 pathway for MS MSCs isolated after AHSCT. MSCs-post showed fold change of 2,89; 1,58; 2,17; 7,84 respectively for ph-p38, ph-CREB, ph-JNK and ph-STAT1 that is similar to MSC-pre (Tab. 7.9). Again transplantation doesn't affect MSCs properties.

Tab.7.9: FC in MS MSCs-post and -pre:

FC LPS/BG	MSC-post	MSC-pre
ph-p38	2,89	2,44
ph-CREB	1,58	2,39
ph-JNK	2,17	2,17
ph-STAT1	7,84	5,01

7.10 Mixed lymphocyte reaction (MLR)

We tested immunosuppressive activity of 3 HD and 3 MS MSCs isolated from BM at least 2 years after AHSCT by MLR. CD4 + T lymphocytes were stimulated with allogeneic DCs in absence (CTR) or presence of MSCs that were added at the dose of 10^4 cells/well (**Fig. 7.10**). MSCs isolated

from MS patients and HD donors had the same inhibitory ability when added in MLR. Our results indicated that in vitro MS MSCs isolated after transplantation didn't lose their immunosuppressive ability during alloreaction.

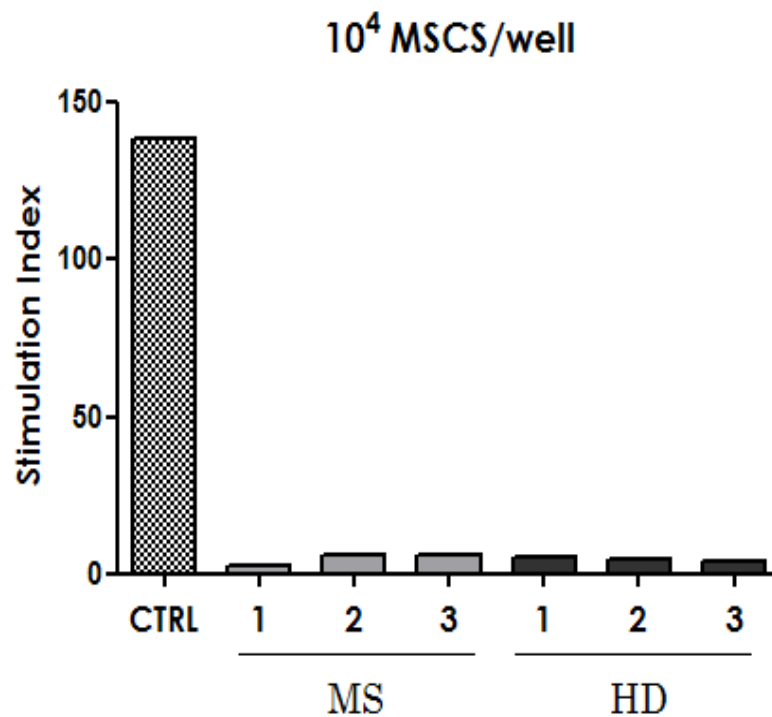

Fig. 7.10 Immunosuppressive activity of MS MSCs isolated after AHSCT during allostimulation of CD4+ T cells. MLR was performed in 96-well U bottom plate: CD4+ T cells (10^5 cells/well) were cultured 4 days with allogeneic LPS activated DCs (10^4 cells/well) alone or with MSCs-post. At day 5 cells were pulsed for 8 h with [3 H]-Thy. Proliferative response is here expressed as stimulation index (SI) calculated by using the following formula= proliferation of T lymphocytes incubated with cellular stimuli with or without MSCs-post/ proliferation of T cells alone. MS and HD MSCs show similar inhibitory effect on proliferative response. Transplant execution has no influence on MSCs immunosuppressive activity. One experiment of three independent ones. CTRL = control. MS = multiple sclerosis. HD = healthy donors.

7.11 Proliferation test: effect of MSCs on autologous T cells response

Whereas recent studies confirmed in vitro inhibition by MSCs of T-cell response (as reviewed in Tolar J et al 2010) contrasting results were found by Darlington and colleagues (2010) showing stimulation by MSCs of Th17 proliferation and IL-17A production. Similarly, polarization of MSCs into an immunosuppressive or pro-inflammatory phenotype based on stimulation of specific toll-like receptors has been reported (DeLaRosa et al, 2010 and Waterman et al, 2010). As there are few studies to date on the immunomodulatory activity of human MSCs to autologous T cells we studied this immunological phenomenon. CD4 T lymphocytes obtained from either the donors of MS MSCs or a third party were stimulated with anti-CD3 and anti-CD28 monoclonal antibodies in absence (CTRL) or presence of MSCs added at the dose of 10^4 and 10^3 cells/well (ratios T/MSCs respectively of 1:10 and 1:100). On the basis of MSCs and T cells origin we performed three different conditions:

- 1st) MS MSCs cultured with autologous CD4 T lymphocytes;
- 2nd) MS MSCs with allogeneic HD CD4 T lymphocytes and
- 3rd) HD MSCs with allogeneic HD CD4 T lymphocytes.

When MSCs were added at the dose of 10^4 cells/wells an increase of T cell proliferation was evident in all three experimental conditions (Stimulation Index, SI, respectively of 4; 4.5 and 3.9). On the other hand when MSCs were added at the dose of 10^3 this effect was increase in the 1st and 2nd conditions and lowered in the 3rd one but this difference is not statistically significant (**Fig. 7.11 B**) (SI respectively of 7.5; 7.6; 4.4). Our results suggested that the pro-inflammatory effect of MSCs at higher dose is not dependent on MSCs origin or T cells donors. However the pro-inflammatory activities of MSCs at lower dose may depend on MSCs origin but again not on T cells donors.

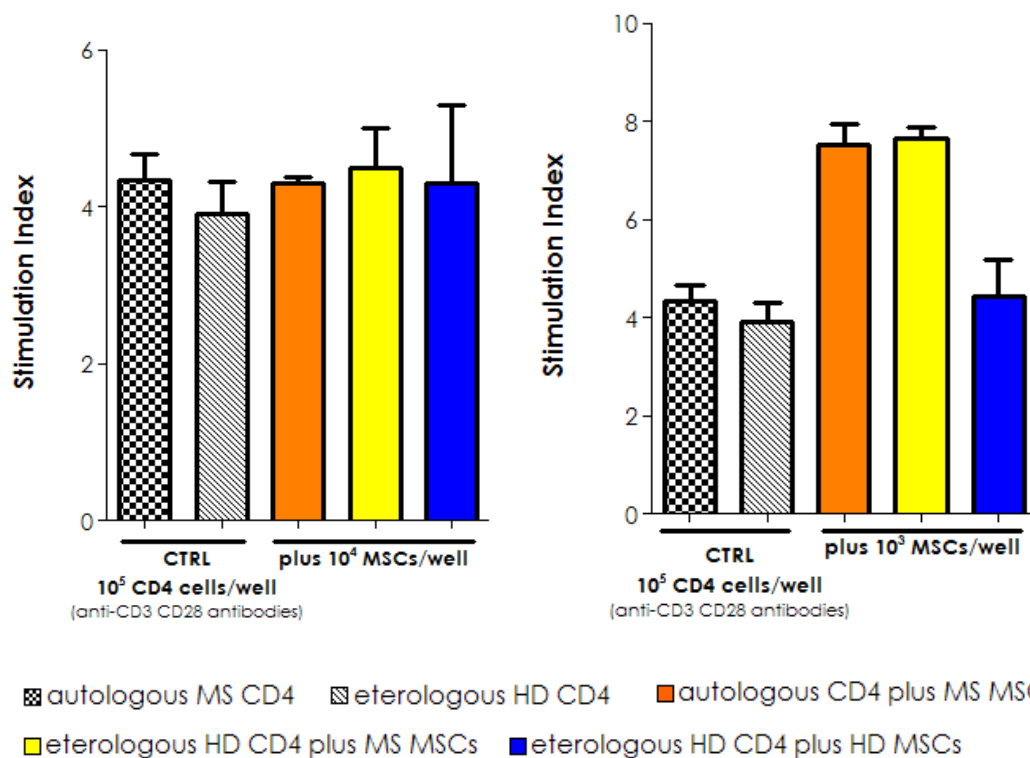

Fig. 7.11 Pro-inflammatory activity of MSCs during anti-CD3 and CD-28 stimulation of CD4+ T cells. Proliferation was performed in 96-well U bottom plate: CD4+ T cells (10^5 cells/well) were stimulated with anti-CD3/CD28 monoclonal antibodies alone (CTRL) or with MSCs added at the dose of 10^4 or 10^3 cells/well. T cell proliferation was evaluated in 4 MS and 4 HD MSCs performing three conditions: 1st = MS MSCs mixed with autologous T cells (orange column); 2nd = MS MSCs cultured with HD eterologous T cells (yellow column); 3rd = HD MSCs cultured with HD eterologous T cells (blue column). Proliferative response is here expressed as stimulation index (SI) calculated by using the following formula= proliferation of T lymphocytes incubated with physiological stimuli with or without MSCs / proliferation of un-stimulated T cells. SI is expressed as mean of 4 experiments. MSCs stimulate proliferative response and this effect is more evident in MS MSCs.

We repeated the evaluation of immunomodulatory activity of MS MSCs isolated after AHSCT by using anti-CD3/CD28 stimulation involving autologous or allogeneic T cells. On the basis of MSCs and T cells origin we performed two different conditions:

- 1st) MS MSCs-post cultured with autologous CD4 T lymphocytes-post and
- 2nd) MS MSCs-post with eterologous HD CD4 T lymphocytes-post.

When MSCs were added at the dose of 10^4 cells/wells MS MSCs-post showed stimulation index (SI) of 2,9 and 3,6 respectively for 1st and 2nd conditions. Similarly when MSCs were added at the dose of 10^3 MS MSCs-post showed SI of 3,1 and 6,2 respectively for the 1st and 2nd condition. We showed that MS MSCs isolated before or after AHSCT had similar SI (Tab. 7.11 A, B) indicating that transplantation doesn't affect MSCs function properties.

Tab. 7.11. Stimulation index in MSCs-pre (PRE) and MSCs-post (POST):

A)

	10 ⁵ autologous CD4 plus 10⁴ MS MSCs	10 ⁵ eterologous HD CD4 plus 10⁴ MS MSCs
PRE	4,0	4,5
POST	2,9	3,6

B)

	10 ⁵ autologous CD4 plus 10³ MS MSCS	10 ⁵ eterologous HD CD4 plus 10³ MS MSCs
PRE	7,4	5,9
POST	3,1	6,7

7.11.1 IFN- γ production

To investigate the pro-inflammatory effect of MSCs on CD4 T lymphocytes observed during proliferation test with anti-CD3 and anti-CD28 antibodies, we evaluated IFN- γ production by Luminex technologies. The analysis was performed on supernatants of T cells obtained from either the donors of MS MSCs or a third party stimulated with anti-CD3 and CD28 antibodies in absence (CTRL) or presence of MSCs added at the dose of

10⁴ and 10³ cells/well. Supernatants were collected from the three experimental conditions mentioned above (1st, 2nd and 3rd conditions, 7.11 paragraph). MS and HD T cells treated with anti-CD3/CD28 antibodies showed similar IFN- γ production in presence of 10⁴ or 10³ MSCs/well, suggesting that IFN- γ profile is not dependent on MSCs dose (data not shown). When MS lymphocytes treated with anti-CD3/CD28 antibodies were cultured with autologous MSCs (1st), T cells showed a significant ($p < 0,05$) higher IFN- γ production compared to stimulated MS T cells in absence of MSCs (CTRL). IFN- γ production was also significantly ($p < 0,05$) higher in 1st condition respect to 3rd one. **(Fig. 7.11.1)**. The significant higher IFN- γ production from T lymphocytes confirmed the MSCs-mediated-stimulation of autologous anti CD3/CD28 T cell proliferative response.

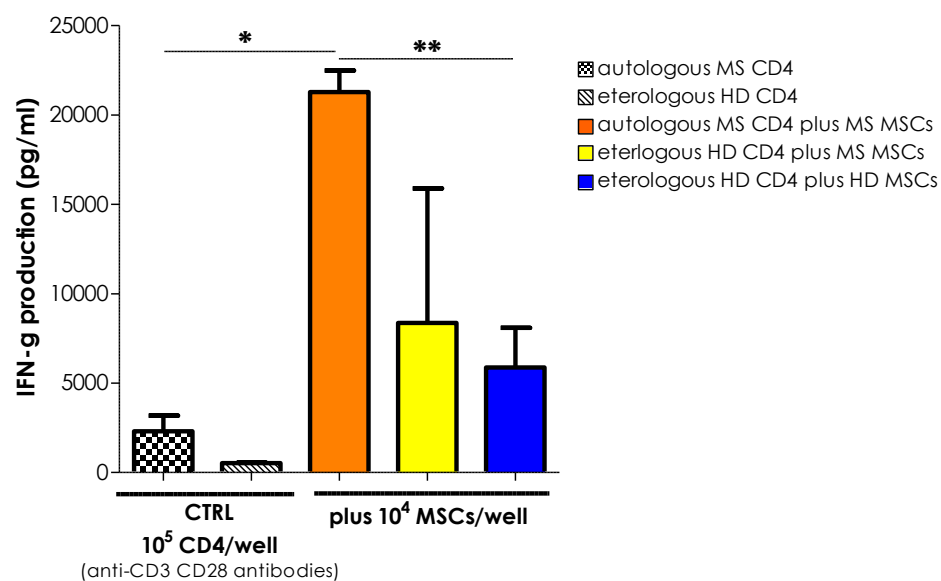

Fig. 7.11.1 IFN- γ production on cell supernatant. IFN- γ production was investigated in CD4⁺ T cells stimulated with anti-CD3/CD-28 antibodies in absence (CTRL) or presence of MSCs added at the dose of 10⁴. IFN- γ production was evaluated in 3 MS and 3 HD MSCs performing three conditions: 1st = MS MSCs mixed with autologous T cells (orange column). 2nd MS MSCs cultured with allogeneic T cells (yellow column). 3rd = HD MSCs cultured with allogeneic T cells (blue column). Data are expressed as mean value \pm SD. Analysis was performed by non parametric t-test indicating that

mean is statistically significant in 1st condition vs patients CTRL (* $p < 0.05$) and in 1st condition vs 3rd one (** $p < 0.05$). MSCs not inhibit IFN- γ secretion from T lymphocytes confirming functional assay data.

7.12 IP-10 production on peripheral blood monocytes

As we have shown that IP-10 production is a peculiarity of BM MSCs and BM serum of MS patients; we evaluated whether this characteristic appeared also in the periphery. We analyzed the supernatant of 6 MS and 5 HD PBMC isolated monocytes by Luminex technology on basal and two stimulated conditions respectively LPS and IFN- γ . MS monocytes showed higher IP-10 production compared with HD samples on basal and after LPS stimulation (for MS mean value of 2286 pg/ml and for HD mean value of 141 pg/ml on basal condition; for MS mean value of 1487 pg/ml and for HD of 76 pg/ml after LPS stimulation). **(Fig. 7.12 A)**. We tested IP-10 expression on the two groups of peripheral blood monocytes (MS and HD) in basal condition and in LPS or IFN- γ stimulated one. When cells were LPS stimulated MS monocytes showed an increased of IP-10 expression level compared to HD confirming Luminex data. On the other hand when cells were resting MS and HD monocytes showed similar IP-10 expression not in agreement with Luminex data maybe due to different mRNA turnover from patients compared to controls **(Fig. 7.12 B)**. Taken together our data showed that IP-10 production by MS monocytes was comparable to that from MS MSCs suggesting a strong correlation between central and peripheral compartment. MS and HD monocytes produced IP-10 at similar extent after IFN- γ stimulation (data not shown) in agreement with literature (as reviewed by Kasama T et al, 2005 and Sebastiani S et al, 2002).

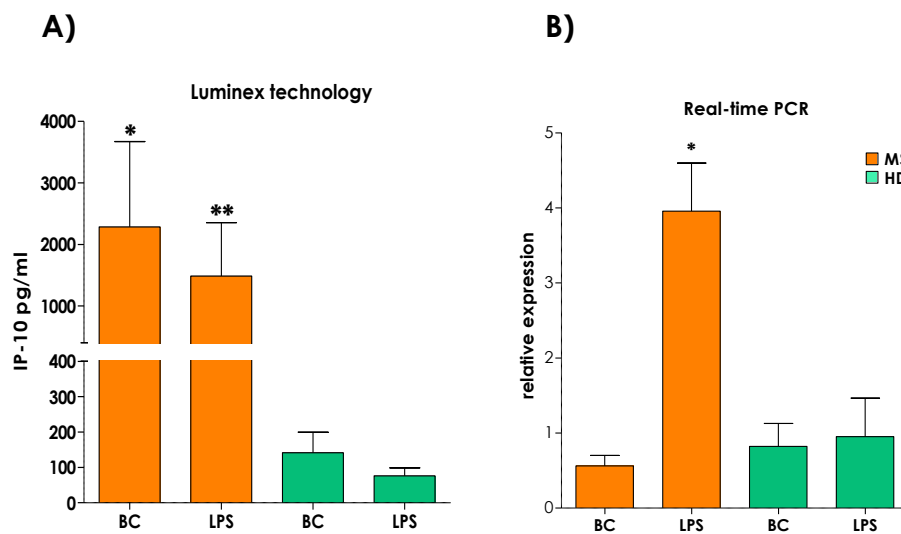

Fig. 7.12 IP-10 production on CD14+ cells supernatants. A) IP-10 production was investigated by LUMINEX technology in 6 MS (gray columns) and 5 HD (black columns) CD14+ monocytes on basal condition (BC) and upon LPS stimulation. Data are expressed as mean value \pm SD. The graph shows that IP-10 is significantly more produced by MS monocytes than controls before and after LPS stimulation. Analysis was performed by non parametric Mann Whitney test indicating that median is statistically significant in BC MS monocytes vs BC HD monocytes at $P < 0,03$ (*) and in LPS MS-monocytes vs LPS HD-monocytes at $P < 0,03$ (**). **B)** IP10 real time PCR, 4 HD and 4 MS sample analyzed before and after LPS stimulation. Data are expressed as mean value \pm SD. MS shows an increase of IP10 expression level compared to HD after LPS stimulation. Analysis was performed by non parametric t test indicating that mean is statistically significant in LPS MS monocytes vs BC MS monocytes $p < 0.0021$ (*).

7.13 Signaling proteins expression profile

As we have shown that IP-10 production is a specific characteristic of MS central and peripheral compartment we repeated signaling protein analysis involved in TLR4 pathway for monocytes. We tested the expression level of STAT-1, NF κ B and I κ B transcription factors in 4 MS and 4 HD PBMC isolated monocytes by Real-time PCR on basal and two

stimulated conditions respectively LPS and IFN- γ . Relative expression is shown as ratio to β -actin. In patients, STAT-1, NFkB and I κ B expression levels were respectively 49.3 (\pm 10.8), 174.3 (\pm 41.2) and 1283 (\pm 396.3) on basal conditions; 95.6 (\pm 30.7), 210.7 (\pm 75.2) and 2453 (\pm 769.7) after stimulation with LPS. In donors ratio were respectively 24.1 (\pm 5.06), 121.8 (\pm 27.1) and 1215 (\pm 535.7) on basal conditions; 40.4 (\pm 18.7), 172.2 (\pm 41.4) and 1412 (\pm 276.9) upon stimulation (**Fig. 7.13 A, B, C**). STAT-1, NFkB and I κ B genes were up-regulated in the patient group compared to controls after LPS stimulation indicating that these down-stream transcription factors correlate with IP-10 production. These data showed again a strong correlation between central and peripheral compartment. MS and HD monocytes showed similar STAT-1, NFkB and I κ B expression profile after IFN- γ stimulation (data not shown).

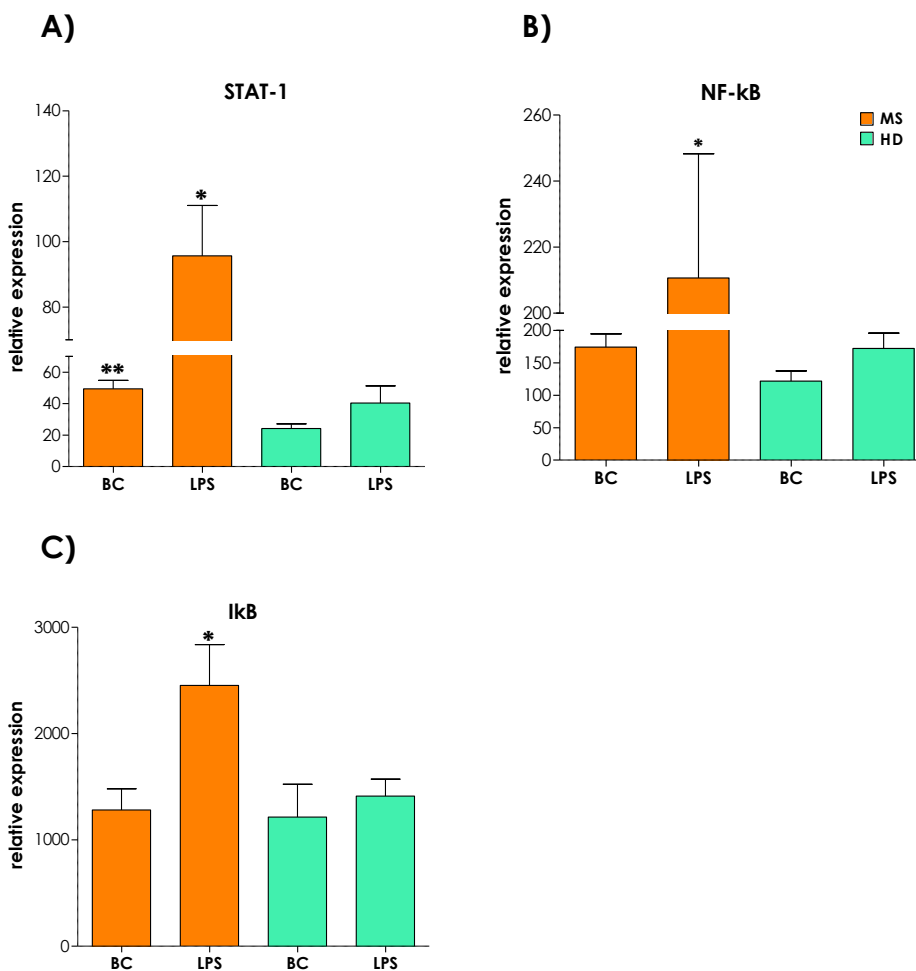

Fig. 7.13 Signaling proteins expression profile. A) STAT-1 was tested by real time PCR in monocytes of 4 patients (MS, orange columns) and 4 controls (HD, light blue ones) on basal condition (BC) and upon 4 hours LPS stimulation. Expression is reported as ratio to β -actin. Here we show that MS monocytes have higher expression level of STAT-1 than HD ones before and after LPS stimulation. Analysis was performed by unpaired t test indicating that means are statistically significant in BC MS monocytes vs BC HD monocytes (* $P < 0.01$) and in LPS MS monocytes vs LPS HD monocytes (** $P < 0.02$) **B, C)** At the same time **NFkB and I κ B** were tested. NFkB and I κ B are up-regulated in both groups, but in MS group the expression levels of NFkB1 and I κ B are significantly higher than HD ones upon stimulated condition (* $P < 0.05$).

7.14 IP-10 production on peripheral blood monocytes after AHSCT

IP-10 production was reanalyzed in peripheral blood monocytes after AHSCT. We analyzed the supernatant of 3 MS PBMC isolated monocytes by Luminex technology on basal and two stimulated conditions respectively LPS and IFN- γ . We compared IP-10 production with the same 3 MS monocytes isolated before and after transplantation. MS monocytes-pre and monocytes-post produced IP-10 at similar extent (**Fig. 7.14 A**). IP-10 production expressed by mean values \pm standard deviation (pg/ml) on basal condition is 646 (± 218) for monocytes-post and 996 (± 129) for monocytes-pre. IP-10 production under LPS stimulation is 497 (± 235) for monocytes-post and 664 (± 250) for monocytes-pre. Monocytes isolated before and after AHSCT produced IP-10 at similar extent after IFN- γ stimulation (data not shown). In our sample we may conclude that AHSCT doesn't affect monocytes IP-10 increased production. This feature was confirmed by Real Time PCR experiment (**Fig. 7.14 B**).

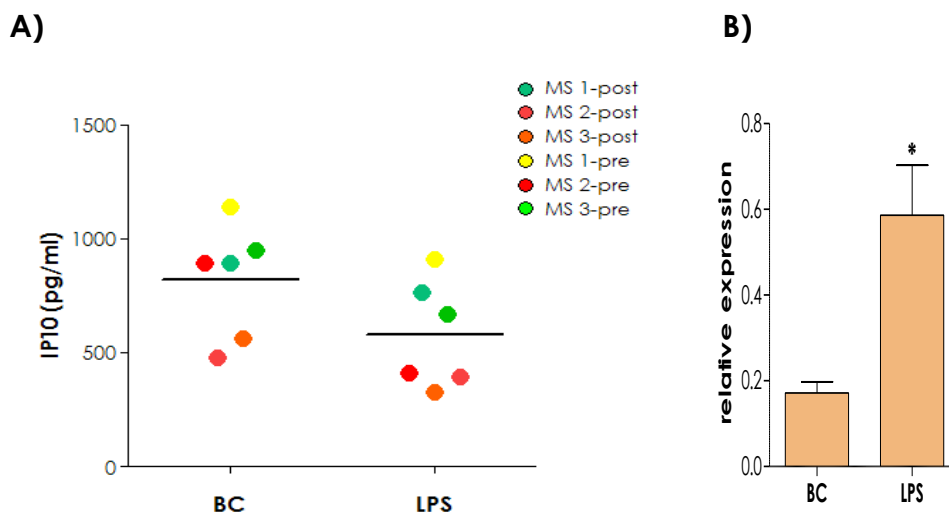

Fig. 7.14 IP-10 production on CD14+ cells supernatants after AHSCT. A) IP-10 production was tested in supernatants of resting and LPS activated cells of 3 MS peripheral blood monocytes isolated before and after AHSCT (monocytes-pre and post). The analysis was performed by Luminex technology. IP-10 production was tested in monocytes from the same 3 patients on basal condition (BC) and after stimulation (LPS) (MS 1-post or -pre, cells originated from patients 1, respectively light blue and yellow circles; MS 2-post or -pre, monocytes from patient 2 respectively pink and red circles; MS 3-post or -pre, cells from patient 3 respectively orange and green circles). Each point is a monocyte independent sample, mean value is represented with horizontal bar. Monocytes-post produced IP-10 as well as monocytes-pre. **B) IP10 real time PCR**, 3 MS sample analyzed before and after LPS stimulation. Data are expressed as mean value \pm SD. LPS stimulation increased significantly IP-10 production in monocytes isolated after transplantation. Analysis was performed by non parametric t test indicating that mean is statistically significant in LPS MS monocytes vs BC MS monocytes $p < 0.0021$ (*).

7.15 Signaling proteins expression profile

We repeated signaling protein analysis involved in TLR4 pathway for MS peripheral blood monocytes isolated after AHSCT. We tested the expression level of STAT-1, NFkB and I κ B transcription factors in 3 MS PBMC isolated monocytes by Real-time PCR on basal and two stimulated

conditions respectively LPS and IFN- γ . Relative expression is shown as ratio to β -actin. In patients, STAT-1, NF κ B and I κ B expression levels were respectively 10.6 (\pm 2.08), 59.8 (\pm 43.5) and 463.5 (\pm 263.6) on basal conditions; 28.2 (\pm 2.2), 73.0 (\pm 26.6) and 760.6 (\pm 123.2) after stimulation with LPS (**Fig. 7.15 A, B, C**). MS peripheral blood monocytes showed similar transcriptional factor expression profile independently from transplantation. Again AH SCT doesn't affect monocytes properties. Monocytes isolated before and after AH SCT showed similar STAT-1, NF κ B and I κ B expression profile after IFN- γ stimulation (data not shown).

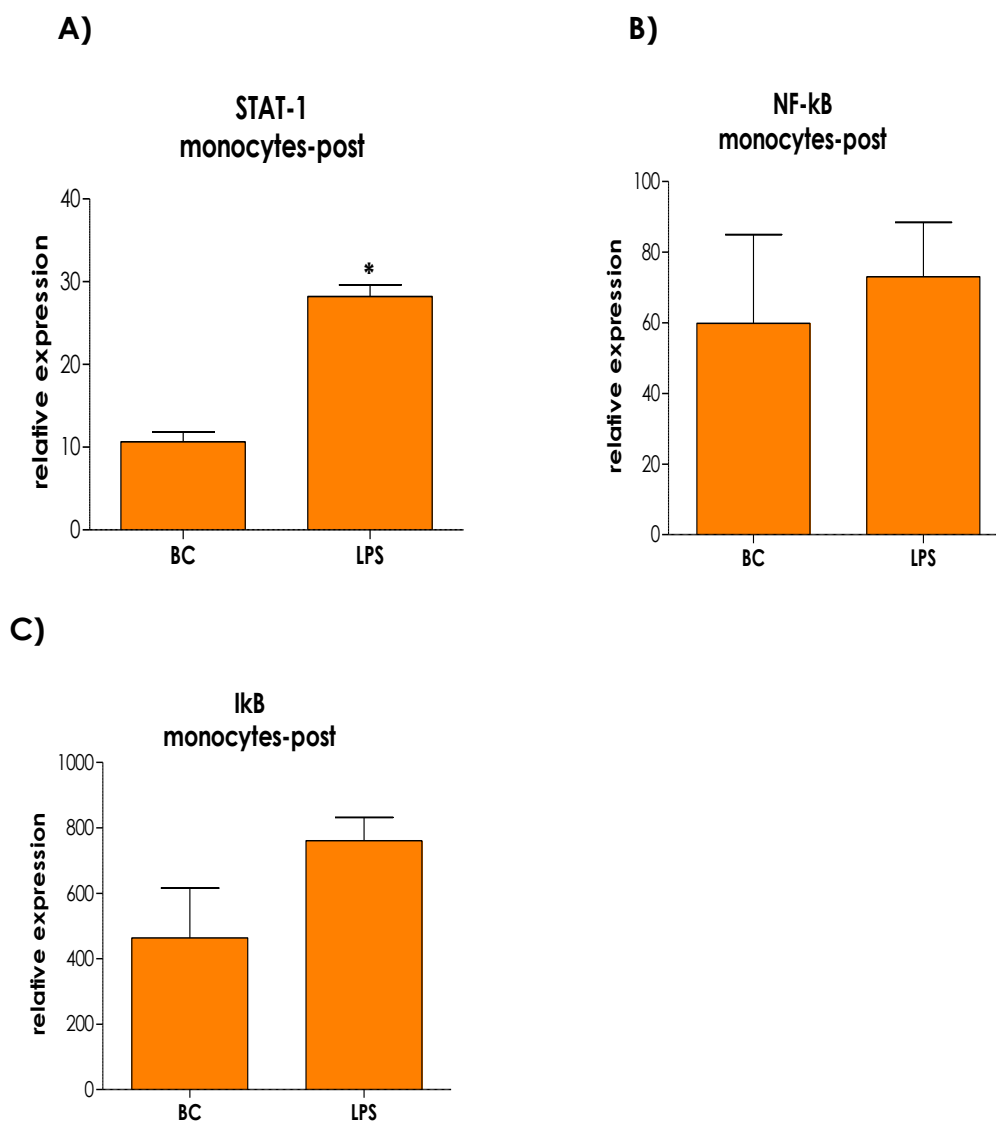

Fig. 7.15 Signaling proteins expression profile. Cells were isolated from patients after transplant execution: **A) STAT-1** was tested by real time PCR in peripheral blood

monocytes of 3 patients on basal condition (BC) and upon 4 hours LPS stimulation. Expression is reported as ratio to β -actin. Here we show that LPS stimulated monocytes have higher expression level of STAT-1 than unstimulated cells. Analysis was performed by unpaired t test indicating that means are statistically significant in LPS MS monocytes vs BC MS monocytes (* $P < 0.02$). **B, C**) At the same time **NF-kB and I κ B** were tested. NF-kB and I κ B are up-regulated after LPS stimulation.

8 DISCUSSION

Mesenchymal stem cells represent a promising and treatment-ready approach to treat neurological diseases such as multiple sclerosis (Martino G et al, 2010). Among stem cells the hematopoietic compartment is currently being evaluated for the potential therapeutic use in patients with severe autoimmune diseases and not responsive to conventional therapies. In this subgroup of patients, autologous transplantation of hematopoietic stem cells has provided encouraging results, preventing progression of disability in patients with severe forms of MS, refractory to conventional therapy (Saccardi R et al, 2012).

In this perspective, the present study elucidated functional and phenotypic characteristics of bone marrow-derived mesenchymal stem cells isolated from multiple sclerosis patients, resistant to conventional treatments and consecutively recruited for an autologous hematopoietic stem cell transplantation. This research came from findings made in our laboratory (Mazzanti et al, 2008) in which we demonstrated that MSCs isolated from 10 MS patients had similar phenotypic and functional properties but significantly greater IP-10 production after TLR4 stimulation with LPS compared to 6 healthy controls. We widened, therefore, the analysis of cytokine and chemokine produced by MSCs over a larger number of samples: 19 MS and 24 HD MSCs.

We analyzed GM-CSF, OPN, IFN- γ , MMP-9, MIG, IL-1 α , IL-1 β , IL-2, IL-6, IL-8, IL-10, IL12-p40, IL-12p70, IL-17, IL-23, and TNF- α and IP-10 production, all factors produced by MSCs (Nombela-Arrieta C et al, 2011) and relevant in the regulation of the inflammatory response and transplant engraftment (Meirelles LS et al, 2009). In our experiments we showed that IP-10, was significantly ($p < 0,05$) produced more frequently in MS LPS stimulated samples compared with HD as we reported in a previous work (Mazzanti et al, 2008). At the same time our data indicated that MSCs from patients and healthy donors produced IL-6, IL-8 and OPN at similar

extent. We noted that IL-6 production was increased after LPS stimulation, demonstrating that TLR4 is capable of impairing the immunosuppressive action of MSCs on T cells (Liotta F et al, 2007). This is quite different from data reported on MSCs suppressive activity on DCs under LPS stimulation (Aldinucci A et al. 2010). Indeed, inflammatory milieu may modulate MSCs action in two directions: immunogenic toward T cells, tolerogenic toward APCs. Production of IL-8, granulocyte-macrophage colony-stimulating factor (GM-CSF) and osteopontin (OPN) were high in MSCs exposed to LPS stimuli in agreement with the role of TLR4 in mediating the capacity of BM-MSCs to support the proliferation and differentiation of CD34(+) hematopoietic stem/progenitor cells (Wang X et al, 2012 and Nilsson SK et al, 2005). In our experimental condition no IFN- γ , MMP-9, MIG, IL-1 α , IL-1 β , IL-2, IL-10, IL12-p40, IL-12-p70, IL-17, IL-23, TNF- α production was detected, as reviewed in the work by Soleymaninejadian and colleagues(2011). We verified IP-10 production in MS and HD samples at three different culture passages. We found that IP-10 production was evident in only MS LPS stimulated samples and it was observed at each passage. Increased IP-10 production from MS MSC was confirmed by Real Time PCR analysis.

IP-10 (interferon γ -induced protein 10), or CXC motif chemokine 10 (CXCL10), is a protein of 98 amino acids encoded by the gene in humans CXCL-10, localized on chromosome 4, within a cluster of genes coding for chemokines (Luster AD, 1985). IP-10 belongs to the CXC chemokine family, small secreted proteins involved in immune and inflammatory response, with a key role in leukocytes recruitment and activation (Booth V et al, 2002). Alteration of IP-10 mRNA and protein expression has been associated with pathogenesis during various infectious diseases, chronic inflammation and autoimmune diseases such as MS (Christen U et al, 2003; Arai K et al, 2002; Charo and Ransohoff, 2006 and Rotondi et al, 2007). Increased levels of IP-10 were detected in CSF from MS patients compared to controls (Sorensen et al, 1999-13.14), and correlate with

lymphocytic pleiocytosis evaluated on CSF that was collected in course of disease attacks. IP-10 plays a significant role in the pathogenesis of allograft rejection following organ transplantation. Enhanced IP-10 production has been observed in recipients of transplants of different organs. This enhanced production likely comes from either the graft or the immune cells and is correlated with an increase in the concentration of circulating IP-10 (Romagnani P et al, 2012). Understanding the factors and mechanisms regulating IP-10 production and secretion is crucial and could allow us to use it not only as a therapeutic target but also as a biomarker to predict the severity of rejection, to monitor the inflammatory status of organ recipients and to facilitate personalized transplantation medicine.

In order to understand the mechanisms that lead to IP-10 production we investigated the role of IFN- β and IFN- γ in this context. These cytokines induced IP-10 production through TLR4 independent signaling. MSCs didn't produce neither IFN- γ nor IFN- β , how it has been shown by ELISA test. Even if MS MSCs showed an increased expression of IFN- β under LPS stimulation by real time PCR experiment, the protein expression was similar to control cells. On the basis of our experiments we showed that IP-10 production isn't induced by IFN- β signaling pathway. Together with IFN, zymosan, a yeast cell wall derivate, could be implicated in IP-10 production trough the activation of TLR2 (Kawai T et al 2011). Our data showed that TLR2 signaling pathway is not responsible of increased IP-10 production, suggesting that TLR4 under LPS stimulation plays specifically a key role in IP-10 gene expression.

Looking at TLR4 pathway, as possible responsible of the IP-10 differential production reported, we found a correlation with the expression levels of proteins directly involved into this signaling pathway.

We analyzed the main transcription factors involved in TLR4 signaling. We showed that both stimulated and un-stimulated MS MSCs expressed

higher levels of STAT-1, NF-kB and IκB compared to controls. A linear regression proved a significant ($P < 0,018$) correlation between STAT-1 gene and IP-10 production in MS MSCs demonstrating that IP-10 gene is downstream target of STAT-1 in agreement with literature (Guha M et al, 2001). Micro array experiment confirmed the higher up-regulation of STAT-1, NF-kB and IκB genes in LPS MS MSCs compared to control ones. At the same time transcriptional analysis evidenced MAPK cascade up-regulation only in stimulated MS MSCs. In particular p-38 gene, the MAPK14 (mitogen-activated protein kinase 14), was strongly up-regulated only in patient group suggesting a specific a specific role of p-38 in transcriptional factors activity in agreement with study in other cellular system (Carter et al, 1999). We demonstrated that in MS MSCs the different gene expression of MAPK and STAT-1 resulted in an altered basal activation state and an increased phosphorylation after TLR4 stimulation of factors forming signaling cascade responsible for IP-10 production and secretion. We showed that MS differ from HD MSCs in terms of phosphorylation state of the signaling protein responsible of IP-10 production. Saying briefly we showed that in MSCs of MS patients LPS activates TLR4 and induces STAT-1 or NF-kB phosphorylation dependent on MAPK ending with activation of downstream gene IP-10. Our results are in agreement with many studies sustaining the existence of a TLR4- but not TLR2-dependent STAT-1 activation and IP-10 production (Gorina et al, 2011; Tamassia et al, 2007). In the **Fig. 8.1**, taken from Gorina's work, we can observe the strong similarity between TLR4 pathway in astrocytes and in our MSCs.

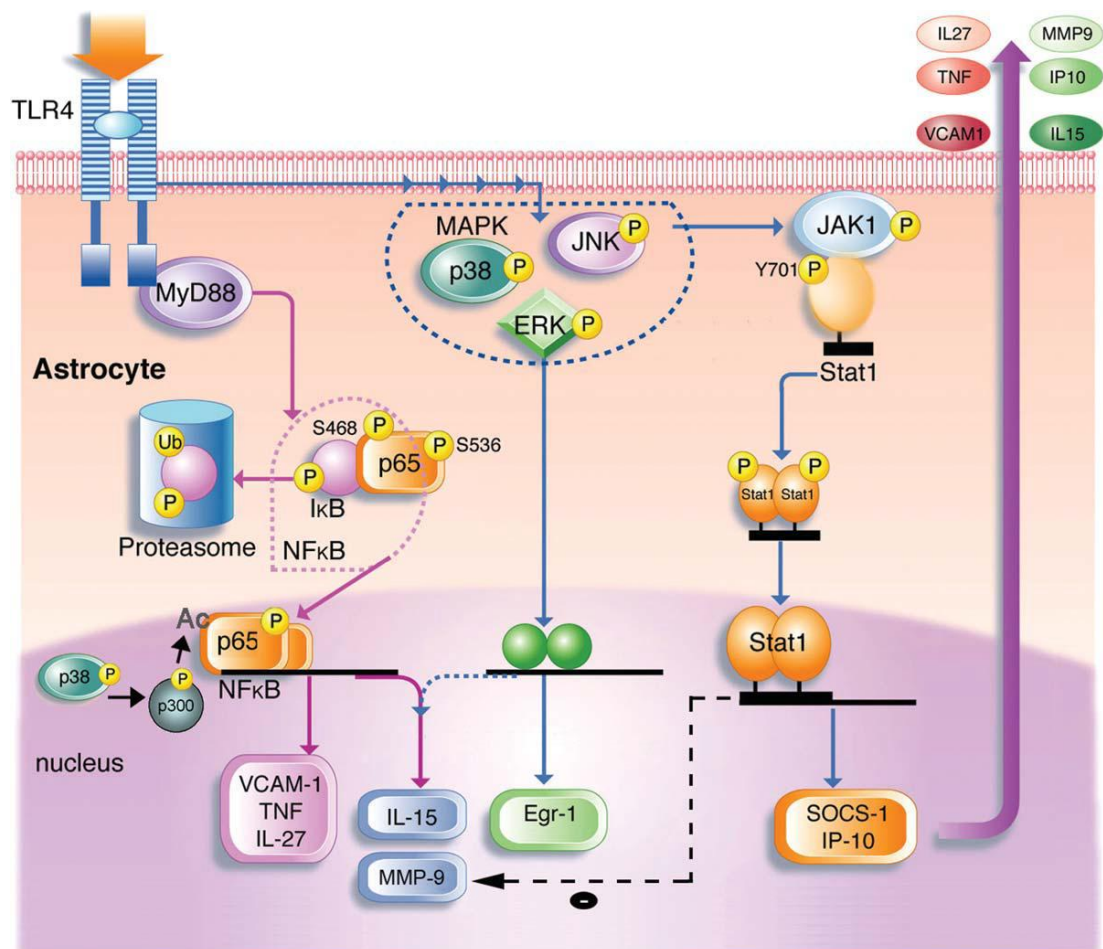

Fig. 8.1 signaling pathway under LPS stimulation in astrocytes. LPS activates TLR-4 and induces early recruitment of MyD88 and subsequent activation of MyD88-dependent pathway leading to NF- κ B activation and induction of target genes. Induction of IFN- β is not detected in astrocytes, but a MyD88-independent pathway induces, Jak1-mediated, tyrosine phosphorylation of Stat1, and activation of downstream genes such as IP-10. Tyrosine Stat1 phosphorylation is dependent on the MAPK, JNK and p38. Phosphorylation of ERK1/2 is involved in Egr-1, IL-15, and MMP-9 induction. Stat1 can exert a negative control on the expression of certain genes, such as MMP-9. MyD88-dependent paths are illustrated in purple, whereas MyD88-independent pathways (arrows) are marked in blue.

At the conditions reported in methods we investigated cytokine/chemokine production in bone marrow serum derived from 7 MS patients. We found that MMP-9, OPN and IP-10 amount were very high in BM serum as reported by other work (Dubois B et al 1999; Sodek J

et al 2000; Romagnani P et al 2012). In particular we noted that OPN and IP-10 were significantly (p -value $<0,05$) correlated with each other (Fig. 3B). On the other hand, we did not detect any IFN- γ , GM-CSF, IL-1 α , IL-1 β , IL-2, IL-6, IL-10, IL12-p40, IL-12p70, IL-17, IL-23, and TNF- α . Indeed, OPN and IP-10 play a critical role during the inflammatory response and are involved in several biological processes. It has been showed an association of OPN with autoimmune disease as multiple sclerosis (Chabas D et al, 2001; Vogt MH et al, 2003). Steinman and colleagues showed that OPN expression is excessive or dysregulated in serum of MS patient indicating a correlation to the pathogenetic mechanism. OPN signaling through integrins can modulate the phosphorylation of kinases (NIK, IKK β) involved in NF- κ B activation (Rice J et al, 2006; Scatena M et al, 1998). NF- κ B regulates expression of many inflammatory cytokines. On the basis of our data we could hypothesize that the high bone marrow concentration of OPN in MS patients modulates IP-10 production through NF- κ B activation. Further studies are warranted to define if OPN is a peculiarity of BM MS patients and to describe regulatory mechanisms involved.

Furthermore, we showed that in MSCs isolated from BM at 2 years or more from AHST, IP-10 production persist and signal transduction proteins implicated in TLR4 pathway were more activated compared to healthy donors. These data suggest that the transplant execution doesn't influence MSCs properties, and that IP-10 production is a stable characteristic of MS MSC. Of note, it is reported that 2yrs after AHST peripheral immunological function is fully recovered, and patients have stable clinical condition without disease activity on MRI (in terms of contrast-enhancing areas and/or new lesions on T2) and without therapeutic need (Saccardi et al, 2006). Together with IP-10 data, we found that MSCs isolated from MS patients after AHST were similar to

MSCs isolated before transplantation in terms of proliferation, phenotype and in vitro differentiation (data not shown). We showed that post-AHSCT MSCs maintained immunomodulatory activity during MLR inhibiting the LPS-induced activation of DCs and favoring the generation of a tolerogenic phenotype. The immunosuppressive activity observed in MSCs of patients did not differ from control ones, in agreement with other studies (Di Nicola et al, 2002; Le Blanc et al 2003). On the other hand we found that MSCs, both before and after AHSCT, did not inhibit autologous anti CD3/CD28 T cell proliferation and IFN- γ secretion. Recent evidence, has shown that in certain settings, MSC can also be immunostimulatory (Darlington PJ et al, 2010; DelaRosa O et al, 2010; Waterman RS et al, 2010). Data from the work of Zhou and colleagues (2013) reported that autologous BM MSCs suppressed mouse spleen T cells proliferation during MLR by means of inhibition of DCs maturation. Instead, MSCs were stimulatory during anti-CD3/CD28 stimulated proliferation founding a correlation between the ability to augment proliferation and CCL2 production from MSCs. Zhou hypothesized that the immunomodulatory role of MSC was determined by a balance between inhibitory and stimulatory factors. These observations underscored the importance of understanding the factors and mechanisms regulating MSCs effects on immune responses in order to manipulate them for therapeutic use.

In this study, we also provide evidence that the effects of TLR ligation on MSCs appeared in peripheral blood monocytes. In particular we observed that bone marrow and peripheral blood derived cells from MS patients showed similar higher IP-10 production compared to controls. We demonstrated that IP-10 overproduction was determined by altered signaling pathway downstream TLR4. Our results are in agreement with many studies sustaining the effect a TLR4-dependent NF-KB activation and IP-10 production (Kawai T, Akira S 2007; Nunez Miguel R et al, 2007. All the features set out above were observed in circulating monocytes

isolated after AHSCT, indicating that transplant execution did not affect such properties and its efficacy was not dependent on IP-10 altered production.

We hypothesized that IP-10 over-expression may result from an intrinsic defect (i.e. epigenetic modifications) of BM derived MSCs and peripheral blood monocytes of severe MS patients. One other explanation may be that altered IP-10 production is a consequence of SM. Data from the study of Guijarro-Muñoz and colleagues (2014) reported that the secretion of proinflammatory cytokines and chemokines such as IP-10 occurred not only after LPS treatment but also in High-mobility group box 1 protein (HMGB1)-stimulated pericytes. Many studies reported that HMGB1, a ubiquitous nuclear protein, is evident in active lesions of MS and EAE and functions as a potent proinflammatory signal through interaction with TLR4. When HMGB1 is released from necrotic cells, such as damaged oligodendrocytes in MS lesions, it drives pro-inflammatory responses (Andersson A et al, 2008; Robinson AP et al, 2013). These findings suggested the existence of a cross-talking signals generating and maintaining a characteristic proinflammatory environment that modulates immunologic response in chronic inflammatory disease as MS. Taken together our data suggested that IP-10 represent a marker of severe disease. Understanding the mechanisms regulating IP-10 production and secretion would be interesting and could allow us to manipulate it for therapeutic use.

References

- Akira S et al. 2004.** *Toll-like receptor signaling* Nat. Rev. Immunol., 4, pp. 499–511
- Akira S et al. 2006.** *Pathogen recognition and innate immunity.* Cell;124:783–801.
- Aldinucci A et al 2008** Regulation Pathway of Mesenchymal Stem Cell Immune Dendritic Cell Actin Distribution: A New Inhibition of Immune Synapse by Altered doi: 10.4049/jimmunol.
- Allers et al 2004** Dynamic of distribution of human bone marrow-derived mesenchymal stem cells after transplantation into adult unconditioned mice. Transplantation;78:503–8.
- Alonso A et al, 2008.** "Temporal trends in the incidence of multiple sclerosis: a systematic review". *Neurology* 71 (2): 129–35
- Anaya JM, 2010** The autoimmune tautology. *Arthritis Res* 12:147 Review
- Andersson A et al, 2008** Pivotal advance: HMGB1 expression in active lesions of human and experimental multiple sclerosis. *Journal of Leukocyte Biology* 84:1248–1255
- Arai K, et al. 2002.** *IP-10 and Mig facilitate accumulation of T cells in the virus-infected liver.* Cell Immunol;219:48–56.
- Ashizawa N et al, 1996.** *Osteopontin is produced by rat cardiac fibroblasts and mediates A(II)-induced DNA synthesis and collagen gel contraction* J. Clin. Invest. 98 (10): 2218–27.
- Ashkar S et al, 2000.** *Eta-1 (osteopontin): an early component of type I (cell-mediated) immunity.* Science 287: 860-4.
- Atlas of Multiple Sclerosis, 2008** World Health Organization e Multiple Sclerosis International Federation
- Bai, L. et al. (2009).** Human bone marrow-derived mesenchymal stem cell induce Th2 polarized immune response and promote endogenous repair in animal models of multiple sclerosis. *Glia*, 1192–1203
- Ballerini C et al, 2004** HLA–multiple sclerosis association in Continental Italy and correlation with disease prevalence in Europe *Journal of Neuroimmunology* 150 (2004) 178–185
- Baranzini SE et al June 2011.** "Revealing the genetic basis of multiple sclerosis: are we there yet?". *Current Opinion in Genetics & Development* 21 (3): 317–24.
- Barhum, Y. et al. (2010)** Intracerebroventricular transplantation of human mesenchymal stem cells induced to secrete neurotrophic factors attenuates clinical symptoms in a mouse model of multiple sclerosis. *J. Mol. Neurosci.* 41, 129–137
- Barten LJ et al, 2010.** New approaches in the management of multiple sclerosis. *Drug Design, Development and Therapy* , 4, 343-366.
- Bartholomew A et al 2002** Mesenchymal stem cells suppress lymphocyte proliferation in vitro and prolong skin graft survival in vivo. *Exp Hematol*, 30:42-48.
- Batten P et al 2006.** *Human mesenchymal stem cells induce T cell anergy and downregulate T cell allo-responses via the TH2 pathway: relevance to tissue engineering human heart valves.* *Tissue Eng.* , 12 (8), 2263-2273.
- Belperio JA et al. 2000.** *CXC chemokines in angiogenesis.* J LeukocBiol;68:1–8.

References

- Berkovich R et al, 2013**;Treatment of acute relapses in multiple sclerosis. *Neurotherapeutics*. 10(1):97–105.
- Bernardo, M. E. et al 2009**. Mesenchymal stroma cells: a novel treatment modality for tissue repair. *Hematopoietic stem cells VII*, 1176, 101-117.
- BeutlerB, 2004** Inferences questions and possibilities in Toll-like receptor signaling*Nature*, 430, pp. 257–263
- Bibliografia
- Bø L et al 2013** Demyelination and remyelination in multiple sclerosis. In: Duncan ID, Franklin RJM, editors. *Myelin Repair and Neuroprotection in Multiple Sclerosis*. New York: Springer; 23–45.
- Bocelli-Tyndall et al. 2007**. Bone marrow mesenchymal stromal cells (BM-MSCs) from healthy donors and auto-immune disease patients reduce the proliferation of autologous- and allogenic-stimulated lymphocytes *in vitro*. *Rheumatology* 4, 403-408.
- Bonecchi R et al. 1998**. Differential expression of chemokine receptors and chemotactic responsiveness of type 1 T helper cells (Th1s) and Th2s. *J Exp Med* 187:129–34.
- Borgogni E et al 2008** "Elocalcitol inhibits inflammatory responses in human thyroid cells and T cells," *Endocrinology*, vol. 149, no. 7, pp. 3626–3634,
- Breitbach et al 2007**. Potential risks of bone marrow cell transplantation into infarcted hearts. *Blood* 110: 1362–1369.
- Buck D et al, 2011**. Treatment of multiple sclerosis: current concepts and future perspectives. *Journal of Neurology* .
- Bustamante MF et al. 2011**. Implication of the Toll-Like Receptor 4 pathway in the response to Interferon- β in multiple sclerosis. *Ann Neurol*. 70(4):634-45.
- by inhibiting CD4 Th17 T cells in a CC chemokine ligand 2-dependent manner. *J Immunol* 2009;182:5994–6002.
- Campbell JD et al. 2004**. Allergic humans are hyporesponsive to a CXCR3-ligand-mediated Th1 immunity-promoting loop. *FASEB*;18:329–31.
- Chabas D et al, 2001**. The influence of the pro-inflammatory cytokine, osteopontin, on autoimmune demyelinating disease. *Science* 294:1731-5
- Chen-Plotkin AS et al 2007**. Encephalopathy, stroke and myocardial infarction with DMSO use in stem cell transplantation. *Neurology*;68:859–61.
- Cho HH et al. 2006**. Role of toll-like receptors on human adipose-derived stromal cells. *Stem Cells* 24, 2744–2752.
- Christen U et al. 2003**. Among CXCR3 chemokines, IFN-gamma-inducible protein 10 KDa (CXC chemokine ligand (CXCL) 10) but not monokine induced by IFN-gamma (CXCL9) imprints a pattern for the subsequent development of autoimmune disease. *J Immunol*;171:6838–45.
- Clanet M et al, 2008**. "Jean-Martin Charcot. 1825 to 1893" (PDF). *Int MS J* 15 (2): 59–61. PMID 18782501.
- Cohen A Jeffrey, 2012**. Mesenchymal stem cell transplantation in multiple sclerosis. *JNS*
- Cohen A Jeffrey, 2013**. Mesenchymal stem cell transplantation in multiple sclerosis. *JNS*

References

- Cole KE et al. 1998.** *Interferon-inducible T cell chemoattractant (I-TAC): a novel non ELR CXC chemokine with potent activity on activated T cells through selective high affinity binding to CXCR3.* *J Exp Med*;187:2009–21.
- Connick P et al. 2012.** *Autologous mesenchymal stem cells for the treatment of secondary progressive multiple sclerosis: an open-label phase 2a proof-of-concept study.* *Lancet Neurol.*11(2):150-6.
- Costantino, CM et al, 2008.** Multiple Sclerosis and Regulatory T cells. *Journal of Clinical Immunology* , 28 (6), 697-706.
- Crayton H et al 2004** A multimodal approach to managing the symptoms of multiple sclerosis. *Neurology*;63(11 Suppl 5):S12–S18.
- Crisan M et al. 2008** A perivascular origin for mesenchymal stem cells in multiple human organs. *Cell Stem Cell* 2008;3:301–313.
- Croitoru-Lamoury J et al. 2007.** *Human mesenchymal stem cells constitutively express chemokines and chemokine receptors that can be upregulated by cytokines, IFN-beta, and Copaxone.* *J Interferon Cytokine Res.*, 27 (1), 53-64.
- Darlington et al. 2010** Reciprocal Th1 and Th17 regulation by mesenchymal stem cells: implications for MS. *Ann Neurol*;68:540–5
- Dazzi F. et al. 2011.** *MSCs and autoimmune disease, Best practice and research clinical haematology* 24 49-57
- Deans, R. J. et al 2000.** *Mesenchymal stem cells: biology and potential clinical uses.* *Exp Hematol.*, 28 (8), 875-884.
- Del Papa N et al 2006.** Bone marrow endothelial progenitors are defective in systemic sclerosis. *Arthritis Rheum*;54:2605–15.
- Delarosa et al 2010** Modulation of adult mesenchymal stem cells activity by toll-like receptors: implications on therapeutic potential. *Mediators Inflamm*: 865601.
- Denhardt DT et al, 2001.** *Osteopontin as a means to cope with environmental insults: regulation of inflammation, tissue remodeling, and cell survival.* *J Clinical Invest* 107:1055-61.
- Di Nicola M et al 2002** Human bone marrow stromal cells suppress T-lymphocyte proliferation induced by cellular or nonspecific mitogenic stimuli. *Blood* 99:3838-3843.
- Disanto G et al 2012** Multiple sclerosis: risk factors and their interactions. *CNS Neurol Disord Drug Targets.* 13(5):545–555. doi: 10.2174/187152712801661266.
- Djouad, F. et al 2003.** *Immunosuppressive effect of mesenchymal stem cells favors tumor growth in allogeneic animals.* *Blood*, 102 (10), 3836-3844.
- Dominici M et al, 2006** Minimal criteria for defining multipotent mesenchymal stromal cells: the International Society for Cellular Therapy position statement. *Cytotherapy*;8:315-317.
- Dubois B et al 1999.** *Resistance of young gelatinase B-deficient mice to experimental autoimmune encephalomyelitis and necrotizing tail lesions* *J Clin Invest*, 104, pp. 1507–1515
- Duddy M et al 2007** Distinct effector of cytokine profiles of memory and naïve human B cell subsets and implication in multiple sclerosis. *J Immunol.*, 178, 6092-6099.
- Dyment DA et al 2004.** "Genetics of multiple sclerosis". *Lancet Neurol* 3 (92): 104–10

engraftment and no ectopic tissue formation. *Stem Cells* 2012;30:557–64.

Freedman et al 2010 The therapeutic potential of mesenchymal stem cell transplantation as a treatment for multiple sclerosis: consensus report of the International MSCT Study Group. *Multiple Sclerosis*, 16, 503–510.

Freedman MS et al 2013. Treatment optimization in MS: Canadian MS Working Group updated recommendations. *Can J Neurol Sci.* 2013;40(3):307–323.

Fu Y et al, 2008. New imaging techniques in the diagnosis of multiple sclerosis. *Expert opinion on medical diagnostics* , 2 (9), 1055-65.

Fujinami RS et al 2006. Molecular Mimicry, Bystander Activation, or Viral Persistence: Infections and Autoimmune Disease. *Clinical Microbiological Reviews* , 19 (1), 80-94.

Gage, F. H. et al, 2000. Mammalian neural stem cells. *Science* , 287, 1433-1438.

Gandhi R et al, 2010 Role of the innate immune system in the pathogenesis of multiple sclerosis. *J Neuroimmunol.* 221, 7-14.

Gao J et al 2001 The dynamic in vivo distribution of bone marrow-derived mesenchymal stem cells after infusion. *Cells Tissues Organs*; 169:12–20.

Gerdoni et al. 2007. *Mesenchymal stem cells effectively modulate pathogenic immune response in experimental autoimmune encephalomyelitis.* *Ann. Neurol.* 61, 219–227.

Gorina R et al 2011 Astrocyte TLR4 activation induces a proinflammatory environment through the interplay between MyD88-dependent NFκB signaling, MAPK, and Jak1/Stat1 pathways. *Glia.* ;59(2):242-55. doi: 10.1002/glia.21094.

Gronseth GS et al, 2000. "Practice parameter: the usefulness of evoked potentials in identifying clinically silent lesions in patients with suspected multiple sclerosis (an evidence-based review): Report of the Quality Standards Subcommittee of the American Academy of Neurology". *Neurology* **54** (9): 1720–5. doi:10.1212/WNL.54.9.1720. PMID 10802774.

Groom J R et al 2013 CXCR3 ligands: redundant, collaborative and antagonistic functions *Immunology and cell biology*

Guha M et al 2001. LPS induction of gene expression in human monocytes. *Cell Signal* 13:85–94.

Guijarro-Muñoz I et al, 2014 Lipopolysaccharide Activates Toll-like Receptor 4 (TLR4)-mediated NF-κB Signaling Pathway and Proinflammatory Response in Human Pericytes. *J Biol Chem.*;289(4):2457-68. doi: 10.1074/jbc.M113.521161

Hafler DA. 2004 Multiple sclerosis. *J Clin Invest.*; 113(6):788–794

Hahn JY et al 2008 Pre-treatment of mesenchymal stem cells with a combination of growth factors enhances gap junction formation, cytoprotective effect on cardiomyocytes, and therapeutic efficacy for myocardial infarction. *J Am Coll Cardiol*; 51:933–943.

Hao L et al. 2012. Mesenchymal stromal cells for cell therapy: besides supporting Hematopoiesis. *Int J Hematol (2012) 95:34–46*

References

- Hare JM et al 2009** A randomized, double-blind, placebo-controlled, dose-escalation study of intravenous adult human mesenchymal stem cells (Prohymal) after acute myocardial infarction. *J Am Coll Cardiol*;54:2277–86.
- He XX et al. 2009.** Expression of Toll-like receptors in human bone marrow mesenchymal stem cells, *Zhongguo Shi Yan Xue Ye Xue Za Zhi.*;17(3):695-9
- Honczarenko M et al. 2006.** Human bone marrow stromal cells express a distinct set of biologically functional chemokine receptors. *Stem Cells.*, 24 (4), 1030-1041.
- Hoogduijn MJ et al. 2010.** The immunomodulatory properties of mesenchymal stem cells and their use for immunotherapy. *Int Immunopharmacol.* 10(12):1496-500.
- Hoppenbrouwers JA et al, 2011.** Genetics of multiple sclerosis. *Biochimica et Biophysica Acta*, 1812, 194-201.
- Horwitz EM et al 1999,** Transplantability and therapeutic effects of bone marrow-derived mesenchymal cells in children with osteogenesis imperfecta. *Nat Med* 1999;5:309–13.
- Horwitz EM et al 2002.** Isolated allogeneic bone marrow-derived mesenchymal cells engraft and stimulate growth in children with osteogenesis imperfecta: implications for cell therapy of bone. *Proc Natl Acad Sci U S A* 2002;99:8932–7.
- Ikeda T et al, 1993.** Osteopontin mRNA is expressed by smooth muscle-derived foam cells in human atherosclerotic lesions of the aorta . *J. Clin. Invest.* 92 (6): 2814–20.
- Janatpour MJ et al. 2001.** Tumor necrosis factor-dependent segmental control of MIG expression by high endothelial venules in inflamed lymph nodes regulates monocyte recruitment. *J Exp Med* ;194:1375–84.
- Janeway Jr CA et al. 2002.** Innate immune recognition. *Annu Rev Immunol*;20:197–216.
- Jiang XX et al 2005** Human mesenchymal stem cells inhibit differentiation and function of monocyte-derived dendritic cells. *Blood* 105 (41), 20–26.
- Kassem M et al 2004** Mesenchymal stem cells: biological characteristics and potential clinical applications. 2004. *Cloning Stem Cells.* 6(4):369-74.
- Kawai T et al. 1999,** Unresponsiveness of MyD88-deficient mice to endotoxin. *Immunity*;11:115–22
- Kawai T, Akira S 2007.** Signaling to NF-kappaB by Toll-like receptors. *Trends Mol Med* 13:460–469.
- Keegan B M et al, 2002.** Multiple sclerosis. *Annual review of medicine* , 53, 285-302.
- Khan SA et al, 2002.** Soluble osteopontin inhibits apoptosis of adherent endothelial cells deprived of growth factors. *J Cell Biochem* 85: 728-36.
- Klyushnenkova et al 2005** T cell responses to allogeneic human mesenchymal stem cells: immunogenicity, tolerance, and suppression. *J Biomed Sci*;12:47–57.
- Koc ON et al 2000** Rapid hematopoietic recovery after coinfusion of autologous-blood stem cells and culture-expanded marrow mesenchymal stem cells in advanced breast cancer patients receiving high-dose chemotherapy. *J Clin Oncol.*; 18: 307–316.

References

- Koc ON et al 2000**, Bone marrow-derived mesenchymal stem cells remain host-derived despite successful hematopoietic engraftment after allogeneic transplantation in patients with lysosomal and peroxisomal storage diseases. *Exp Hematol* 1999;27:1675–81.
- Korn, T et al, 2008**. Pathophysiology of Multiple Sclerosis. *Journal of Neurology* , 255, suppl 6, 2-6.
- Kouroumalis A et al. 2005** *The chemokines CXCL9, CXCL10, and CXCL11 differentially stimulate G alpha i-independent signaling and actin responses in human intestinal myofibroblasts.* *J Immunol*;175:5403–11.
- Krampera M et al. 2003**. *Bone marrow mesenchymal stem cells inhibit the response of naive and memory antigen-specific T cells to their cognate peptide.* *Blood*, 101, 3722-3729.
- Krampera M et al. 2006**. Regenerative and immunomodulatory potential of mesenchymal stem cells. *Current Opinion in Pharmacology*, 6, 435–441.
- Lalu MM et al 2012** Safety of cell therapy with mesenchymal stromal cells (SafeCell): a systematic review and meta-analysis of clinical trials. *PLoS One*;7:e47559,
- Larghero J et al 2008**, Phenotypical and functional characteristics of in vitro expanded bone marrow mesenchymal stem cells from patients with systemic sclerosis. *Ann Rheum Dis*;67:443–9.
- Lasagni L et al. 2003** *An alternatively spliced variant of CXCR3 mediates the inhibition of endothelial cell growth induced by IP-10, Mig, and I-TAC, and acts as functional receptor for platelet factor 4.* *J Exp Med*;197:1537–49.
- Lassmann 1999**, *Mechanism of demyelination and tissue damage in multiple sclerosis,* *Acta Neurol Belg* 99 : 6-10
- Lassmann H. 2013** Pathology and disease mechanisms in different stages of multiple sclerosis. *J Neurol Sci*.
- Lazarus, H.M. et al. (2005)**. Cotransplantation of HLA-identical sibling culture-expanded mesenchymal stem cells and hematopoietic stem cells in hematologic malignancy patients. *Biol. Blood Marrow Transplant.* **11**, 389–398
- Le Blanc et al. 2008** Mesenchymal stem cells for treatment of steroid-resistant, severe, acute graft-versus-host disease: a phase II study. *Lancet* 371: 1579–1586.
- Lloyd CM et al. 2000** *CC chemokine receptor (CCR)3/eotaxin is followed by CCR4/monocyte-derived chemokine in mediating pulmonary T helper lymphocyte type 2 recruitment after serial antigen challenge in vivo.* *J Exp*;191:265–74.
- Lo BK et al. 2010** *CXCR3/ligands are significantly involved in the tumorigenesis of basal cell carcinomas.* *Am J Pathol* 176:2435–46.
- Loetscher M et al. 1998** *Lymphocyte-specific chemokine receptor CXCR3: regulation, chemokine binding and gene localization.* *Eur J Immunol* ;28:3696–705.
- Luster AD et al. 1985** *γ-Interferon transcriptionally regulates response gene containing homology to platelet proteins.* *Nature*;315: 672–6.
- Luster AD et al. 1987** *Biochemical characterization of a gamma interferon inducible cytokine (IP-10).* *J Exp Med*;166:1084–97.

References

- Mancardi, G. et al 2008.** Autologous haemopoietic stem-cell transplantation in multiple sclerosis. *Neurology The Lancet* , 7, 626-636.
- Marrie RA et al 2004.** "Environmental risk factors in multiple sclerosis aetiology". *Lancet Neurol* **3** (12): 709–18
- Martino et al 2010** Stem cell transplantation in multiple sclerosis: current status and future prospects. *Nature Reviews Neurology*, 6, 247–255.
- Mazzanti et al 2008.** *Differences in mesenchymal stem cell cytokine profiles between MS patients and healthy donors: Implication for assessment of disease activity and treatment* . *J Neuroimmunol.* 13;199(1-2):142-50.
- McMichael AJ et al 1997** Does immunosuppressive ultraviolet radiation explain the latitude gradient for multiple sclerosis? *Epidemiology* 1997;8:642-5.
- Mendez-Ferrer S et al. 2010** Mesenchymal and haematopoietic stem cells form a unique bone marrow niche. *Nature* 2010;466:829–834.
- Miller DH et al 1998,** The role of MR technique in understanding and managing MS *Brain* 121 3-24
- Minagar A 2013** Current and future therapies for multiple sclerosis. *Scientifica (Cairo)*. 249101
- Muraro, P. A. et al 2004.** Using stem cells in multiple sclerosis therapies. *Cytotherapy* , 6 (6), 615-620.
- Murray ED et al 2012,** "Depression and Psychosis in Neurological Practice". In Daroff R, Fenichel G, Jankovic J, Mazziotta J. *Bradley's neurology in clinical practice*. (6th ed. ed.). Philadelphia, PA: Elsevier/Saunders. ISBN 1-4377-0434-4.
- Murry CE et al, 1994.** *Macrophages express osteopontin during repair of myocardial necrosis* . *Am. J. Pathol.* 145 (6): 1450–62.
- Myhr KM et al, 2009** Corticosteroids in the treatment of multiple sclerosis. *Acta Neurologica Scand Suppl.*;(189):73–80.
- N_u~nez Miguel R et al, 2007.** A dimer of the Toll-like receptor 4 cytoplasmic domain provides a specific scaffold for the recruitment of signaling adaptor proteins. *PLoS One* 2:e788.
- Nauta AJ et al 2006** Donor-derived mesenchymal stem cells are immunogenic in an allogeneic host and stimulate donor graft rejection in a non-myeloablative setting. *Blood* 108: 2114–2120.
- Nauta AJ et al 2006,** Mesenchymal stem cells inhibit generation and function of both CD34+ derived and monocyte-derived dendritic cells. *J. Immunol.* 177, 2080–208
- Nilsson SK et al, 2005** *Osteopontin, as a key component of the hematopoietic stem cell niche and regulation of primitive hematopoietic progenitor cells.* *Blood* 106:1232-9.
- Parekkadan, B. 2010.** Mesenchymal Stem Cells as Therapeutics. *The Annual Review of Biomedical Engineering*, 12, 87-117.
- Pelit I et al. 2002.** G-CSF induces stem cell mobilization by decreasing bone marrow SDF-1 and up-regulating CXCR4. *Nature Immunology*, 3 (7), 687-694.

- Pevsner-Fisher et al. 2007.** *Toll-like receptors and their ligands control mesenchymal stem cell functions.* *Blood* 109, 1422-1432.
- Pierrot-Deseilligny C et al 2013** Contribution of vitamin D insufficiency to the pathogenesis of multiple sclerosis *Ther Adv Neurol Disord* (2013) 6(2) 81–116
- Pluchino, S. et al, 2003.** Injection of adult neurospheres induces recovery in a chronic model of multiple sclerosis. *Nature* , 422 (6933), 688-694.
- Polman CH et al, 2005.** Diagnostic Criteria for Multiple Sclerosis: 2005 Revisions to the "McDonald Criteria". *Annals of neurology* , 58, 840-846.
- Prince CW et al, 1987.** 1,25-Dihydroxyvitamin D3 regulates the biosynthesis of osteopontin, a bone-derived cell attachment protein, in clonal osteoblast-like osteosarcoma cells. *Coll Relat Res* 7 (1): 305–313.
- Proost P et al. 2006,** Coexpression and interaction of CXCL10 and CD26 in mesenchymal cells by synergising inflammatory cytokines: CXCL8 and CXCL10 are discriminative markers for autoimmune arthropathies, *Arthritis Res Ther*, 8, p. R107
- Qin S, et al. 1998**The chemokine receptors CXCR3 and CCR5 mark subsets of T cells associated with certain inflammatory reactions. *J Clin Invest*;101:746–54.
- Rafei M et al. 2009** Mesenchymal stromal cells ameliorate experimental autoimmune encephalomyelitis
- Raicevic G et al. 2010** Inflammation modifies the pattern and the function of Toll-like receptors expressed by human mesenchymal stromal cells, *Human Immunology* Volume 71, Issue 3, Pages 235–244
- Ramaiah SK et al, 2007.** Pathophysiological role of OPN in hepatic inflammation, toxicity and cancer. *Toxicol Sci* 103:4-13.
- Ramasamy, R. et al 2007.** Mesenchymal stem cells inhibit dendritic cell differentiation and function by preventing entry into the cell cycle. *Transplantation*, 83 (1), 71-76.
- Ramesh G et al 2013,** Cytokines and Chemokines at the Crossroads of Neuroinflammation, Neurodegeneration, and Neuropathic Pain, Hindawi Publishing Corporation *Mediators of Inflammation*, ID 480739, 20 pages <http://dx.doi.org/10.1155/2013/480739>
- Rangswami H et al, 2006.** Osteopontin: role in cell signaling and cancer progression. *Trends Cell Biol* 16: 79-87.
- Rappert A et al. 2004** CXCR3-dependent microglial recruitment is essential for dendrite loss after brain lesion. *J Neurosci*;24:8500–9.
- Rasmussen I et al 2005.** Mesenchymal stem cells inhibit lymphocyte proliferation by mitogens and alloantigens by different mechanisms. *Exp. Cell Res.*, 305, 33-41.
- References**
- Ren G et al 2012** Concise review: mesenchymal stem cells and translational medicine: emerging issues. *Stem Cells Transl Med.* 1(1):51-8. doi: 10.5966/sctm.
- Rice J et al, 2006** Courter DL, Giachelli CM, Scatena M. Molecular mediators of alphavbeta3-induced endothelial cell survival. *J Vasc Res* ;43:422–36.

References

- Robinson AP et al, 2013** High-mobility group box 1 protein (HMGB1) neutralization ameliorates experimental autoimmune encephalomyelitis. *J Autoimmun* 43:32-43. doi: 10.1016/j.jaut.2013.02.005.
- Rolls A et al. 2007** Toll-like receptors modulate adult hippocampal neurogenesis *Nat. Cell Biol.* 9 (9): 1081–8. doi:10.1038/ncb1629. PMID 17704767
- Romagnani P et al, 2012** CXCL10: a candidate biomarker in transplantation *Clin Chim Acta.*;413(17-18):1364-73. doi: 10.1016/j.cca.2012.02.009
- Romagnani P et al. 2001** Interferon-inducible protein 10, monokine induced by interferon gamma, and interferon-inducible T-cell alpha chemoattractant are produced by thymic epithelial cells and attract T-cell receptor (TCR) alphabeta+ CD8+ single-positive T cells, TCR gamma-delta+ T cells, and natural killer-type cells in human thymus. *Blood*;97:601–7.
- Romagnani P et al. 2004** CXC chemokines the regulatory link between inflammation and angiogenesis. *Trends Immunol* 25:201–9.
- Rot A et al. 2004** Chemokines in innate and adaptive host defense: basic chemokines grammar for immune cells. *Annu Rev Immunol*;22:891–928.
- Rotondi M et al 2007** Role of chemokines in endocrine autoimmune disease. *EndocrSoc*;28:492–520.
- Rubio, D. et al 2005** Spontaneous human adult stem cell transformation. *Cancer Res.* **65**, 3035–3039
- Saccardi R et al. 2006.** Autologous stem cell transplantation for progressive multiple sclerosis: update of the European Group for Blood and Marrow Transplantation autoimmune diseases working party database. *Mult. Scler.* 12, 814-23.
- Saccardi R et al. 2008.** Haematopoietic stem cell transplantation for autoimmune disorders. *Curr Opin Hematol.* 15(6):594-600.
- Saccardi R et al. 2012.** A prospective, randomized, controlled trial of autologous haematopoietic stem cell transplantation for aggressive multiple sclerosis: a position paper. *Mult. Scler. J* 18(6) 825–834.
- Sacchetti B et al. 2007** Self-renewing osteoprogenitors in bone marrow sinusoids can organize a hematopoietic microenvironment. *Cell* 2007;131:324 –336.
- Salcedo Ret al. 2000** Differential expression and responsiveness of chemokine receptors (CXCR1-3) by human microvascular endothelial cells and umbilical vein endothelial cells. *FASEB J*;14:2055–64.
- Sallusto F et al. 1999** Switch in chemokine receptor expression upon TCR stimulation reveals novel homing potential for recently activated T cells. *Eur J Immunol*;29:2037–45.
- Salmaggi A et al 2002.** Expression and modulation of IFN- γ -inducible chemokines (IP-10, Mig, and I-TAC) in human brain endothelium and astrocytes: possible relevance for the immune invasion of the central nervous system and the pathogenesis of multiple sclerosis, *Journal of Interferon and Cytokine Research*, vol. 22, no. 6, pp. 631–640
- Scatena M et al, 1998** Almeida M, Chaisson ML, Fausto N, Nicosia RF, Giachelli CM. NF-kappaB mediates alphavbeta3 integrin-induced endothelial cell survival. *J Cell Biol*;141:1083–93.

References

- Schallmoser K et al 2008** Rapid large-scale expansion of functional mesenchymal stem cells from unmanipulated bone marrow without animal serum. *Tissue Eng Part C Methods* ; 14: 185–196.
- Siatskas C et al. 2010A** *Consensus Statement Addressing Mesenchymal Stem Cell Transplantation for Multiple Sclerosis: It's Time!* *Stem Cell Rev.*6(4):500-6. **Strieter R Met al. 1995** *The role of CXC chemokines as regulators of angiogenesis.* *Shock*;4:155–60.
- Sodek J et al, 2000** *Osteopontin.* *Crit Rev Oral Biol Med* ;11:279–303.
- Soleymaninejadian E et al 2011**, Immunomodulatory properties of mesenchymal stem cells: cytokines and factors. *Immunol.; Review* 67(1):1-8. doi: 10.1111/j.1600-0897
- Sørensen TL et al 2002** Multiple sclerosis: a study of CXCL10 and CXCR3 co-localization in the inflamed central nervous system *J Neuroimmunol.*;127(1-2):59-68.
- Sospedra, M et al, 2006.** Molecular mimicry in multiple sclerosis. *Autoimmunity* , 39 (1), 3-8.
- Spaggiari, G. et al 2006.** Mesenchymal stem cell-natural killer cell interactions: evidence that activated NK cells are capable of killing MSCs, whereas MSCs can inhibit IL-2-induced NK-cell proliferation. *Blood*, 107 (4), 1484-1490.
- Spain RI et al 2009**, Recent developments in multiple sclerosis therapeutics. *BMC Med.* ;7:74.
- Spittau B et al, 2012** "IL6 protects MN9D cells and midbrain dopaminergic neurons from MPP+-induced neurodegeneration," *NeuroMolecular Medicine*, vol. 4,pp. 317–327
- Stadelmann C et al, 2011.** Multiple sclerosis as a neurodegenerative disease: pathology, mechanisms and therapeutic implications. *Current Opinio in Neurology* , 24, 224-229.
- Steinman L et al, 2001.** Multiple sclerosis: a two-stage disease. *Nature Immunology* , 2 (9), 762-64.
- Steinman L et al, 2002.** *Multiple sclerosis: deeper understanding of its pathogenesis reveals new targets for therapy.* *Ann Rev Neurolosc* 25:491-505.
- Sui Y et al 2006** CXCL10-induced cell death in neurons: role of calcium dysregulation. *Eur J Neurosci.*;23(4):957-64.
- Tabera, S. et al 2008.** The effect of mesenchymal stem cells on the viability, proliferation and differentiation of B-lymphocytes. *Haematologica*, 93 (9), 1301-1309.
- Tamassia N et al. 2007,** Molecular mechanisms underlying the synergistic induction of CXCL10 by LPS and IFN-gamma in human neutrophils. *Eur J Immunol.*;37(9):2627-34.
- Tanaka, F. et al. (2008).** Exogenous administration of mesenchymal stem cells ameliorates dextran sulfate sodium-induced colitis via anti-inflammatory action in damaged tissue in rats. *Life Sci.* **83**, 771–779
- Tolar, J et al 2006.** Sarcoma derived from cultured mesenchymal stem cells. *Stem Cells* **25**, 371–379
- Trojano M et al, 2001.** "The differential diagnosis of multiple sclerosis: classification and clinical features of relapsing and progressive neurological syndromes". *Neurol. Sci.* **22** (Suppl 2): S98–102. doi:10.1007/s100720100044. PMID 11794488.
- Tsang BK et al 2011** "Multiple sclerosis- diagnosis, management and prognosis.". *Australian family physician* **40** (12): 948–55. PMID 22146321

References

- Tyndall A et al. 2009.** Multipotent mesenchymal stromal cells for autoimmune diseases: teaching new dogs old tricks. *Bone Marrow Transplantation* , 1-8.
- Uaesoontrachoon K et al, 2008.** Osteopontin and skeletal muscle myoblasts: Association with muscle regeneration and regulation of myoblast function in vitro . *Int. J. Biochem. Cell Biol.* 40 (10): 2303–14.
- Uccelli A et al. 2008.** Mesenchymal stem cells in health and disease. *Nature Immunology*, 8, 726-736.
- Uccelli A et al. 2010.** Why should mesenchymal stem cells (MSCs) cure autoimmune diseases? *Curr Opin Immunol* 2010; **22**: 768–74.
- Vinader Vet al 2012** A beginner's guide to chemokines. *Future Med Chem.* 4(7):845-52. doi: 10.4155/fmc.12.49.
- Vogt MH et al, 2003.** Elevated osteopontin levels in active relapsing-remitting multiple sclerosis. *Ann.Neurol* 53:819-22.
- Von Bahr L et al 2012,** Analysis of tissues following mesenchymal stromal cell therapy in humans indicate limited long-term engraftment and no ectopic tissue formation. *Stem Cells*;30:557–64.
- Wai PY et al, 2004** The role of OPN in tumor metastasis. *J Surg Res* 121:228-41.
- Wan T et al, 2010.** AIP1 functions as Arf6-GAP to negatively regulate LR4 signaling. *J Biolhem.*;285(6):3750-7. doi: 10.1074/jbc.M109.069385
- Wandering KP et al 2000.** Association between clinical disease activity and Epstein-Barr virus reactivation in MS. *Neurology* , 55, 178–84.
- Wang X et al, 2012** Toll-like receptors 2 and 4 mediate the capacity of mesenchymal stromal cells to support the proliferation and differentiation of CD34⁺ cells *Exp Cell Res.* 1;318(3):196-206. doi: 10.1016/j.yexcr.
- Weber GF et al 1996** Receptor ligand interaction between CD44 and osteopontin (Eta-1). *Science* 271:509-12.
- Weber MS et al, 2011.** the role of antibodies in multiple sclerosis. *Biochimica et Biophysica Acta* , 1812, 239-245.
- Whetten-Goldstein K et al, 1998.** A comprehensive assessment of the cost of multiple sclerosis in the United States. *Mult Scler.* 1998;13(5):419–425
- Wilson A et al. 2006.** A. Bone-marrow haematopoietic-stem-cell niches. *Nature Rev. Immunol.*, 6, 93-106.
- Yokosaki Y et al, 2005.** Distinct structural requirements for binding of the integrin α v- β 6, α v- β 3, α v- β 5, α 5 β 1 and α 9- β 1 to osteopontin. *Matrix* 24: 418-27.
- Yong-Chen Lu et al.2008,** LPS/TLR4 signal trasduction pathway *Cytokine* 42 145–151.
- Yoo SW et al. (2008).** Mesenchymal stem cells promote proliferation of endogenous neural stem cells and survival of newborn cells in a rat stroke model. *Exp. Mol. Med.* **40**, 387–397
- Zappia E et al 2005** Mesenchymal stem cells ameliorate experimental autoimmune encephalomyelitis inducing T-cell anergy. *Blood* 2005;106:1755– 1761.

References

- Zhou Y et al, 2013** Mesenchymal stromal cells augment CD4+ and CD8+ T-cell proliferation through a CCL2 pathway. *Cytotherapy* (10):1195-207. doi: 10.1016/j.jcyt. Epub
- Zlotnik A et al. 2000** *Chemokines: a new classification system and their role in immunity.* *Immunity*;12:121–7.