

II-2016

**Quaderni di Linguistica
e Studi Orientali- QULSO**

Working papers in Linguistics and Oriental Studies

UNIVERSITA' DEGLI STUDI DI FIRENZE

DIPARTIMENTO DI LINGUE, LETTERATURE E STUDI INTERCULTURALI

BIBLIOTECA DI STUDI DI FILOLOGIA MODERNA: COLLANA, RIVISTE E LABORATORIO

Quaderni di
Linguistica e Studi Orientali
*Working Papers in
Linguistics and Oriental Studies*

2

Editor

M. Rita Manzini

FIRENZE UNIVERSITY PRESS

2016

Quaderni di Linguistica e Studi Orientali / Working Papers
in Linguistics and Oriental Studies -

n. 2, 2016

ISSN 2421-7220

ISBN 978-88-6655-832-3

DOI: <http://dx.doi.org/10.13128/QULSO-2421-7220-2>

Direttore Responsabile: Beatrice Töttösy

CC 2016 Firenze University Press

La rivista è pubblicata on-line ad accesso aperto al seguente
indirizzo: www.fupress.com/bsfm-qulso

The products of the Publishing Committee of Biblioteca di Studi di Filologia Moderna: Collana, Riviste e Laboratorio (<<http://www.lils.uni.it/vp-82-laboratorio-editoriale-open-access-ricerca-formazione-e-produzione.html>>) are published with financial support from the Department of Languages, Literatures and Intercultural Studies of the University of Florence, and in accordance with the agreement, dated February 10th 2009 (updated February 19th 2015), between the Department, the Open Access Publishing Workshop and Firenze University Press. The Workshop promotes the development of OA publishing and its application in teaching and career advice for undergraduates, graduates, and PhD students in the area of foreign languages and literatures, and of social studies, as well as providing training and planning services. The Workshop's publishing team are responsible for the editorial workflow of all the volumes and journals published in the Biblioteca di Studi di Filologia Moderna series. QULSO employs the double-blind peer review process. For further information please visit the journal homepage (<<http://www.fupress.com/bsfm-qulso>>).

Editing e composizione: Laboratorio editoriale Open Access (<laboa@lils.uni.it>)

Cover: Salomè H. Varje

La presente opera è rilasciata nei termini della licenza Creative Commons Attribuzione - Non commerciale - Non opere derivate 4.0 Italia, il cui testo integrale è disponibile alla pagina web: <<http://creativecommons.org/licenses/by-nc-nd/3.0/it/legalcode>>

CC 2016 Firenze University Press
Università degli Studi di Firenze
Firenze University Press
via Cittadella, 7, 50144 Firenze, Italy
www.fupress.com
Printed in Italy

Direttore scientifico / Editor

M. Rita Manzini, Università degli Studi di Firenze

Comitato scientifico / Scientific Advisory Board

Claude Audebert, Université d'Aix-Marseille
Fabrizia Baldissera, Università degli Studi di Firenze
Andrea Calabrese, University of Connecticut
Elisabetta Carpitelli, Université de Grenoble
Guglielmo Cinque, Università di Venezia Ca' Foscari
Riccardo Contini, Università L'Orientale di Napoli
Roberta D'Alessandro, Universiteit Leiden
John Denton, Università degli Studi di Firenze
Francesca Ditifecci, Università degli Studi di Firenze
Steven Fassberg, Hebrew University of Jerusalem
Marina Foschi, Università degli Studi di Pisa
Francesca Fraccaro, Università degli Studi di Firenze
Marcello Garzaniti, Università degli Studi di Firenze
Maria Teresa Guasti, Università di Milano Bicocca
Adam Ledgeway, Cambridge University
M. Rita Manzini, Università degli Studi di Firenze
Antonio Moreno-Sandoval, Universidad Autónoma de Madrid
Anna Roussou, University of Patras
Michael Ryzhik, Bar-Ilan University, Israel
Leonardo M. Savoia, Università degli Studi di Firenze
Giuseppe Scattolin, Università Gregoriana, Roma
Aldo Tollini, Università di Venezia Ca' Foscari
Beatrice Tottossy, Università degli Studi di Firenze
Sun Yixue, Tongji University, Shanghai
Ida Zatelli, Università degli Studi di Firenze

Comitato di Redazione / Editorial Board

John Denton, Università degli Studi di Firenze
Francesca Ditifecci, Università degli Studi di Firenze
Francesca Fraccaro, Università degli Studi di Firenze
Marcello Garzaniti, Università degli Studi di Firenze
Rosangela Lai, Università degli Studi di Firenze
M. Rita Manzini, Università degli Studi di Firenze
Leonardo M. Savoia, Università degli Studi di Firenze
Ida Zatelli, Università degli Studi di Firenze

Segretario di redazione / Editorial Assistant

Rosangela Lai, Università degli Studi di Firenze

Caporedattore / Managing Editor and Journal Manager

Arianna Antonielli, Università degli Studi di Firenze

Contents

<i>From the Editor</i>	9
<i>Propagation and preservation of rounded back vowels in Lucanian and Apulian varieties</i> Leonardo M. Savoia, Benedetta Baldi	11
<i>Osservazioni sulla sostanza dei primitivi nella Teoria degli Elementi e il rapporto tra fonologia e fonetica</i> Laura Bafile	59
<i>The syntax of (ditransitive) predicates of transference in Dialectal Brazilian Portuguese</i> Heloisa Maria M. Lima-Salles	79
<i>Code-switching in relative clauses: Some theoretical implications</i> Gloria Cocchi, Cristina Pierantozzi	97
<i>Agreement in Italian SLI children: a comparison between Determiner-Noun, Subject-Verb and Object-Verb agreement</i> Vincenzo Moscati, Ilenia Vottari	123
<i>Acquisition of Locative Case Markers in Finno-Ugric languages: A case study on Finnish L2</i> Giulia Bellucci, Lena Dal Pozzo	141
<i>L'occitano di Guardia Piemontese tra conservazione, innovazione e mutamento: analisi di un corpus</i> Irene Micali	175
<i>Per una descrizione linguistica dell'ucraino</i> Salvatore Del Gaudio	209
<i>Time in Ancient Hebrew Lexicon: The Case of yrḥ and ḥdš</i> Alberto Legnaioli	235

<i>Tarfiq versus Tazyīq. On a Rare Sufi Term in Ibn Baṭṭūṭā and Jewish-Muslim Interactions in Medieval Egypt</i> Giuseppe Cecere	265
<i>Terminologia e corpora a supporto della didattica della lingua cinese in ambito specialistico</i> Serena Zuccheri	291
<i>Contributors</i>	323

Propagation and preservation of rounded back vowels in Lucanian and Apulian varieties

*Leonardo M. Savoia and Benedetta Baldi**

Università degli Studi di Firenze

(<leonardomaria.savoia@unifi.it>, <benedetta.baldi@unifi.it>)

Abstract:

This article addresses the descriptive and theoretical aspects of the relation between the cavity properties of vowels and consonants. This relation is studied on the basis of some vocalic harmonizing processes depending on the adjacency between [u] and a velar (or labial) consonant in the domain of the stressed nucleus. Propagation of /u/ and preservation of /u/ in pre-tonic position in Southern Italian varieties provide the crucial testing ground for our analysis; one last process we investigate is the distribution of the metaphonic outcomes in a Salento dialect. The nature of phonological representations is the other question we are concerned with. This point has been recently explored specifically in relation to the explanatory role of the structure and its relation with the melodic content of segments. Our proposal is that the phonological structure of the string corresponds in a direct and exhaustive way to the elementary melodic properties of the segments.

Keywords: Harmonizing Processes, Phonological Theory, Vowel-Consonant Adjacency

The main issue dealt with in this article is the relation between cavity properties of vowels and consonants. This relation has different treatments in the literature, either separating consonant features from vowel features or identifying them as the same cluster of properties. Specifically, our analysis concerns two related phenomena, propagation of /u/ and preservation of /u/

* The authors elaborated the article together; however, for Italian evaluation purposes, Benedetta Baldi takes responsibility for sections 2, 3, 3.1, 4, 7. All dialectal data we discuss and analyze have been collected by means of field investigations with native informants in the period 2014-2016. As regards the examples, for the sake of simplicity we have introduced only the glosses, where f = feminine, m = masculine, pl= plural, sg = singular. The examples are transcribed in IPA.

in pre-tonic position in Southern Italian varieties. Both phenomena belong to the set of processes, documented in the literature, involving adjacency between [u] and a velar (or labial) consonant. The nature of phonological representations is the second question that interests us here. This point has been recently explored, specifically in relation to the explanatory role of structure and its relation with the melodic content of segments (Kaye 2014; Pöchtrager and Kaye 2013; Pöchtrager 2006, 2015; van Oostendorp 2013).

In what follows, the fundamental tenets of Government Phonology (GP) will be the starting point for the analysis. In this light, prosodic organization and licensing relations between positions will be analysed as a reflex of the phonological content of segments in the relevant domains. A fundamental requirement we will adopt is the one concerning the phonetic interpretability of representations, assuming the *Projection principle* and *Non-arbitrariness* of processes (Kaye 1986/87; Kaye 1990; Kaye, Lowenstamm and Vergnaud 1990). These constraints, preserved in successive versions of the theory, define phonological representations as “fully interpretable at any stage in a phonological derivation” (Pöchtrager and Kaye 2013: 52).

1. *Some theoretical and empirical questions*

Relations between segments are generally manifested by harmonizing/phonological agreement effects and by prosodic strength devices (duration, intensity, melodic height), namely prominence. These properties are traditionally interpreted in terms of what is called prosodic and syllabic structure. In classical GP framework (Kaye 1990; Charette 1991; Harris 1994; Kaye, Lowenstamm, Vergnaud 1990) the acoustic potential of a segment depends on whether it is in a licensed position or is a licenser or governor. A critical point is the relation between the phonological potential of the segments and the structural and prosodic organization, insofar as some degree of redundancy is present in the autosegmental model. With the *Non-segmentalist Hypothesis* Jensen (1994) tries to reduce these redundancies by assuming that acoustic differences of segments “are direct phonetic interpretations of particular positions within the constituent structure”. The structure is to be “understood weakly as the governing and licensing relations that obtain between points in a given domain” (Jensen 1994: 73). This type of approach has inspired the CV model proposed in Lowenstamm (1996). Recent discussion in GP argues for the idea that at least a part of the traditional melodic properties can be treated as structural properties. Pöchtrager (2006, 2010), Pöchtrager and Kaye (2013), and Kaye (2014) support a revision of GP whereby the processes concerning the melodic content of segments can be reduced to structural relations, a solution that, however, has the undesirable effect of multiplying abstract positions, namely positions lacking a surface equivalent.

For the sake of clarity, let us consider the proposal discussed in Pöchtrager (2006) and Pöchtrager and Kaye (2013), assuming that prosodic structure is

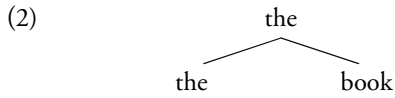

(Chomsky 1995: 246)

Let us tentatively apply this idea to the structural categories in phonology. We can assume that an operation of phonological Merge takes phonological objects (segments), x and y , and forms a new object, i.e. the set $\{x, y\}$ - a melodic domain. In this light, the structural arrangements that emerge in phonological representations, as the head-complement relations in syllable, foot, etc. can be interpreted “as reflexes of SM interface properties”, in the sense of Chomsky (2013: 39). This means that the structural representation of relations traditionally assumed as basic, such as the nuclear head-complement, $C_{\text{coda}}-C_{\text{onset}}$ and V-V relations, can be understood as derivative properties introduced in the process of SM interpretation. Hence, metrical constructs are projections from vowels or consonants which license the phonological objects which they combine with. Concretely, the phonological sequences are organized around segments endowed with resonance/intensity properties enabling them to regulate the concatenation of consonants and form a domain. In other words, the prosodic structure is a reflection of the melodic content of the segments in the string. If we are on the right track, we conclude that the surface structural arrangement is not fixed once and for all by a rigid structural model and that syllable and foot can be understood as domains of prominence/licensing.

Consider, by way of an example, rising (light) diphthongs like $[je\ w\alpha]$, vs falling (heavy) diphthongs like $[ai\ au]$. Usually the literature based on metrical models and GP assigns different structures to rising diphthongs, treated as contour segments or syllabic sequences, compared to falling diphthongs, considered true complex nuclei. So, the head role is assigned to the first position inside the nucleus. This excludes the possibility of interpreting rising diphthongs as a realization of a binary nucleus. Along these lines, Booij (1989), resuming a proposal of Anderson (1974), analyses the rising sequences of Frisian, as $[fwot\text{ə}n]$ *fuotten* ‘feet’, as combinations where the first part is associated with the syllabic onset. According to Booij (1989: 326) the process of breaking removes the first part of the diphthongized mid vowels from the nucleus, associating it to the onset on the basis of the universal principle optimizing CV structure, as in (3).

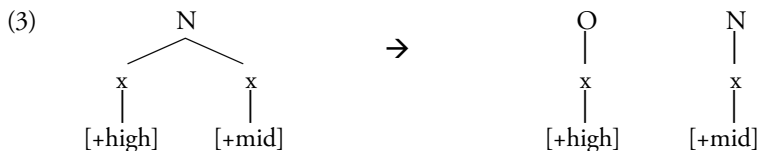

In GP this asymmetry is expressed in terms of a universal constraint requiring left-right governing inside the constituents (Kaye 1986/1987, Kaye, Lowenstamm and Vergnaud 1990); this solution is substantiated in Harris (1990) on the basis of the requirement whereby the head cannot be less complex than the governed position (Complexity Condition), whereby “in branching nuclei the governee can only ever be simplex”, as in (4) (Harris 1990: 276).



The fallacies in this characterization of diphthongs are highlighted in Pöchtrager (2015); in particular, he points out that the Complexity Condition does not exclude diphthongs such as *ia*, i.e. typical light diphthongs. Nevertheless, in other approaches, complex nuclei including onglide sequences are admitted on the basis of general considerations concerning sonority prominence. For example, Harris (1985) analyses Spanish rising diphthongs, occurring both in open and closed syllables, cf. [ˈhjerro] *hierro* “iron”, [ˈpwerta] *puerta* “door”, assuming that the full vowel has the role of head by virtue of its sonority degree independently of the reciprocal order between full vowel and glide. Moreover, in many languages the distribution of rising diphthongs is sensitive to the syllabic structure, connecting them to the open syllables exactly like falling diphthongs in other languages. This distribution characterizes standard Italian (Marotta 1988), as in (5):

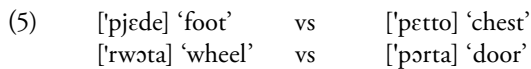

A natural conclusion is that a clear-cut distinction between rising and falling diphthongs on the basis of their relation with syllabic contexts is not proved by the data. Pöchtrager (2015) and Kaye (2014) submit a treatment that gets over the impasse in the traditional analysis of diphthongs, by assuming a structure reproducing the traditional X-bar organization of syntactic phrases. So, the difference between light and heavy diphthongs is accounted for by the different points of insertion of the onglide, in a Specifier position (further removed from the head), and the offglide (closer to the head), in an adjunct to the head position, as in (6).

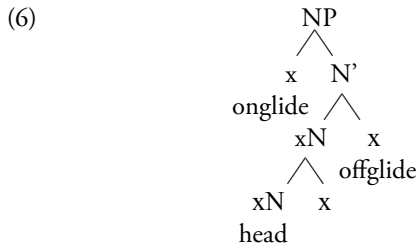

These structural solutions recall the cartographic treatment of syntax, in the sense that the sequencing of elements gives rise to rigid universal templates, with a large recourse to the abstract/latent positions. Anyway, important insights are implied in the proposals of Pöchtrager and Kaye: specifically, the idea that some sort of embedding characterizes the phonological structures/categories, as shown in (1) and (6), and that the coda consonant is simply the consonant licensed by the nucleus, as in (1a).

A reduced notion of structure in phonological representations can be pursued, in which relational properties project from the qualitative properties (types of assimilation and harmonization, strength prominence) of the segments. So, for instance, diphthongs can be represented as a set including two slots hosting cavity properties sufficient to license the stress domain. In the spirit of a minimalist approach, structural relations can be reduced to the licensing of the melodic content in the domains that compose the sequence. We go a step further and assume that licensing/legitimization is nothing but the phonetic interpretation of the string organization, specifically the (partial) melodic assimilation between the prominent phonological content (head) and the other segments in its domain. Generally, structural relations are manifested by the assimilation in melodic properties or the asymmetry between a strong position (licenser) and a weak position. The partial melodic depletion of weak positions can be thought of as a form of phonological assimilation or agreement, in the sense that the head subsumes part of the resonance properties of the string.

If we apply the rationale of the Chomskyan proposal in (2) to the phonological organization of the strings, an elementary representation that registers domains and licensing is obtained. The ability of a nucleus (or possibly a consonant) to license a phonological string, i.e. its domain,¹ is implemented by the sharing of properties (harmony, propagation, assimilation) or simply by phonological fullness/prosodic strength. The prosodic strength refers to

¹ The idea that the rhyme is, essentially, the projection of the nucleus belongs to the conceptual background of GP (Kaye, Lowenstamm and Vergnaud 1985, 1990).

the nature of the melodic content associated to a position; this means that it will be the nuclei that generally define domains, as suggested in (7). We will say that only consonant and vowel slots exist and that they realize the order established by licensing. In (7a) the prominent part of the nucleus takes the weak part of diphthong - its complement - in its domain giving rise to the right-left order. A left-right diphthong, as in the English word [faɪnd], has the reverse distribution, as in (7b).

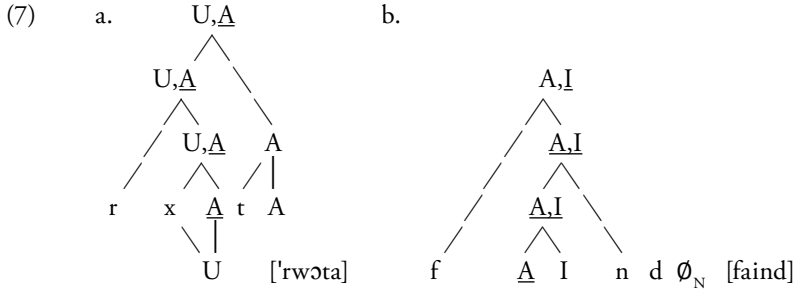

In the representations in (7), the vocalic heads introduce the domains that organize the sequence. Thus, in (7a,b) the projection reflects the vocalic domains, possibly also of the unrealized nuclei, as in (7b), configuring the prosodic domain of the stressed nucleus. It is of note that in the following sections we will use lightly simplified representations.

(7) suggests that consonants depend on the licensing capacity of the vowels; however, nothing in (7) prevents consonants from contributing to legitimizing the sequence. Returning to [bit] vs. [bid] in (1), we can assign them the two representations in (8); contrary to [t] in (8a), [d] in (8b) shares with the second part of the nucleus the low-frequency component L (slack vocal cords), contributing to licensing the vocalic space in the sequence. It can be interesting to consider how the four-way distinction *bid-bit-bead-beat* characterizing consonant sonority in languages such as English can be captured. In the light of the preceding discussion, the nuclear domain can include melodic material associated to the consonant regardless of the duration of the vowel. Thus, in the long nucleus in [bi:d] *bead* t sonority is licensed by a low-frequency component L shared by the vowel and consonant, in (8c). In [bi:t] *beat*, in (8d) the nucleus combines with a unvoiced obstruent.



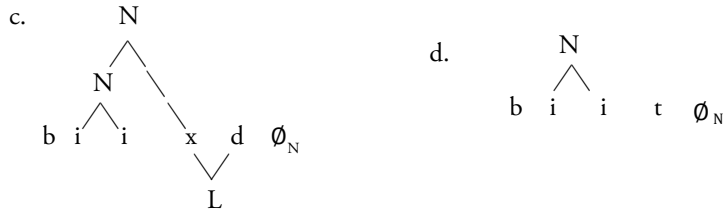

The gist of this proposal is that there is no longer a need for a head to be fixed by virtue of a pre-defined structural arrangement. All that is necessary is a sequence where a perceptually prominent melodic content interprets or affects the melodic properties in the other slots in its domain. (1) and (7) suggest that, contrary to the traditional contrast whereby the recursion would characterize only syntax, phonology can include some type of recursion on condition that a different categorization of the phonological objects is available. In other words classical syllabic structure probably fails in identifying the proper categories.

Naturally, we would underline that our approach aspires to some predictivity, in the sense of constraining the possible representations. The idea we pursue in this work is that prosodic structure of the string is nothing but the distribution of the melodic asymmetries of the segments. As a consequence the possible arrangements do not vary in an arbitrary way but will be determined by the properties of the vowels and consonants. Specifically, nuclei derive their role from their acoustic fullness, involving intensity and duration associated to the stress; similarly, the cavity properties of consonants will contribute to modulating the prosodic configuration of the string. The relation between the segments inside a domain can be interpreted by assimilatory/harmonizing processes such as those here investigated.

In what follows we will apply the interpretive potential of the reduced notion of structure introduced in (7), to the analysis of some harmonizing processes. In Section 2, a sketch of metaphony, and syllabic differentiation is presented in the terms of the approach here proposed. In Section 3, [u] propagation sensitive to the nature of the adjacent consonant is discussed by comparing a canonical GP treatment with as treatment based on the model in (7). Section 4 is devoted to a dissimilative phenomenon which seems to confirm the sharing of [U] by velars and labials. In Sections 5, 6 and 7, this model provides the theoretical and conceptual foundations for interpreting some processes depending on the relation between vowels and adjacent consonants. In all cases, the simple adjacency seems to be involved. So, we can wonder why not to have recourse to this notion rather than assume a poorer, minimalist, notion of structural representation.

The reverse question seems in turn to be not less correct, namely why a rigidly predictive structure would be necessary, as in GP and other metrical

theories,² if adjacency is in many cases sufficient. If in treating adjacency we need not use structural notions, what is the use of the structure if there are elementary processes that escape it? Normally, prosodic models are understood as formal devices translating phonetic properties of the strings of segments into metric-syllabic categories. However, adjacency and in general the linear order of segments is not interpretable by means of structural formalisms, unless complex structural constraints are deployed. In this sense, adjacency seems to remain a sort of pre-theoretical notion, concerning sensorimotor procedures. Our proposal attempts to formulate a model in which adjacency and linear order are not a different level of representation but are incorporated as a property of the prosodic organization of the string. Achieving this aim requires a reduced notion of structure, in which the segments in the string are organized on the basis of their melodic/phonological content properties.

2. Preliminary remarks on metaphony, syllabic differentiation and propagation in Southern Italian varieties

Metaphony is an assimilatory process largely attested in Italo-Romance varieties, including Sardinian varieties, whereby the stressed nucleus partially or completely agrees in the degree of aperture with the following (original/underlying) high vowel, [i u], inside the word (cf. Rohlfs 1966 [1949]). A type of variation emerges that concerns the status of the post-tonic non-final vowel in the proparoxytones, because only in Southern Italian and Sardinian varieties this vowel is active and triggers metaphony. Two fundamental types of Italo-Romance metaphony are recognized: high-mid vowels [e o] [-high] rise to [i u] [+high], whereas metaphony of low-mid vowels [ɛɔ] [-ATR] brings about different results including a [+ATR] segment, namely [e o], diphthongs [iə uə], [i u], according to different varieties (Maiden 1985, 1987; Savoia and Maiden 1997). An alternation pattern generally emerges, that can be exemplified by the data in (9a) concerning the North-Calabrian dialect of *Morano*, where the low-mid stressed vowels metaphonize to high-mid corresponding outcomes.³

² Not all metrical approaches to the syllable are equally restrictive as GP. Specifically, the notion of rhyme in some models assigns the second position indifferently either to a consonant or to a vocalic element (Goldsmith 1990). Moraic models, in turn, assign two moras to a two-slots rhyme regardless of the nature of the second position. In these frameworks the weight of the syllable does not distinguish between a vocalic or a consonantal segment in the second position. However, syllabic approaches share the idea that the prominent position inside the rhyme is on the left, i.e. the first vocalic element, as seen in the discussion concerning Booij (1989) in (3). In this sense, the model here proposed differentiates from both the traditional metrical approaches and the moraic ones insofar as it excludes a pre-defined structural asymmetry inside the prosodic domains.

³ In *Morano* dialect metaphony is partially morphologized given that the original 3rd class inflection *-e* has been replaced by 2nd class ending *-u*. In these contexts metaphony does

In the phonological literature, metaphony has different treatments. Calabrese (1998) connects metaphony to spreading of [+high] from the final vowel. Walker (2005), Savoia (2015, in press a), explain metaphony as the result of licensing of aperture properties by the stressed nucleus. The constraints in (9b,c) formulate this requirement for raising and ATR metaphony.

- (9) a. [ˈvecca] ‘old.sg.f’ vs [ˈveccu] ‘open.sg.m’
 [ˈpɾevətə] ‘priest’ vs [ˈpɾevətə] ‘piests’
 [ˈnɔva]/[ˈnɔvə] ‘new.sg./pl.f’ vs [ˈnovu]/[ˈnovi] ‘new.sg./pl.m’
 [ˈɔvə] ‘eggs’ vs [ˈovu] ‘egg’
 [ˈɔrtərə] ‘garden.pl’ vs [ˈortu] ‘garden.sg’
 [ˈgrɔssa] ‘big.fsg’ vs [ˈgrossu] ‘big.msg’

Morano

b. *Raising metaphony (of high-mid vowels)*

Contrastive [+high] ([i u] vs. [e o]) in the stressed nucleus licenses [+high] in the following vowel

c. *ATR metaphony of low-mid vowels*

Contrastive [+ATR] ([e o] vs. [ɛ ɔ]) in the stressed nucleus licenses [+ATR] in the following vowel

Independently of the specific solution, what we see is that metaphony corresponds to a harmonic domain in which the stressed nucleus shares with the following nucleus a subset of properties. Essentially, the occurrence of [i u] in final (or post-tonic) position requires the headed resonance element [I]/[U] in the stressed nucleus, thus arriving at the alignment on the aperture degree.

Metaphony is not interested with preserving a particular place configuration, but it retains and strengthens, by extending it along the string, the acoustic polarization introduced by high vowels. More precisely, high vowels have a low-frequency F1 that separates them from the mid and low vowels. It is this property that is duplicated by metaphony on the lexical/underlying mid stressed nucleus. In this sense, for metaphony to apply it is indifferent if [I] or [U] are involved in the head or in the trigger. We can tentatively assume that a specialized element [F1], characterizing the low frequency configuration of the fundamental vowels [i u], is involved in metaphony. The harmonizing process implements licensing of the formantic composition of the vowels, as in (10a). Its spreading, or rather its sharing, determines a vowel interpretable as high or as a [+ATR]. So, in combination with headed elements [I]/[U] in high-mid vowels [e o], [F1] further enhances low frequency of F1 giving

not apply, as in the case of [ˈrɛntu] ‘tooth’, where the stressed low-mid vowel is preserved in spite of the following high vowel.

rise to [i u], [F1, I/U]. In combination with non-headed [I]/[U] in low-mid vowels [ɛ ə], enhancing is realized as a change to a headed content [F1, I/U, A], namely a mid [+ATR] vowel [e o],⁴ as in (10b). In any case, [F1] has the role of the prominent element in the melodic content of the vowel.

- (10) a. The head vowel licenses [F1] in final/post-tonic position in the prosodic (foot) domain

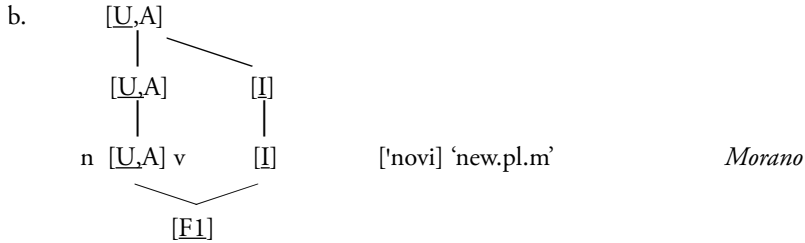

Naturally, we keep assigning the front/back vowels their own place element [I]/[U]. All need assume is that [F1] introduces a contrastive basic acoustic information.

In many dialects metaphony is morphologized consequently to weakening to [ə] of the post-tonic vowels, as, for example, in Lucanian, Calabrian and Apulian dialects we will consider in the following sections. As a consequence, alternations such as those in (11) for *Cerchiara* (Calabria), *Cirigliano* and *Stigliano* (Lucania) varieties reflect no longer a surface perceivable phonetic mechanism but allow for the underlying information connected with the distinctions masculine vs feminine and singular vs plural. Following Calabrese (1998), we can assume that the relevant height property is associated to the inflectional morphemes, so triggering metaphony. We notice that the alternation patterns can intertwine with other phonological processes; in the case of *Stigliano* we notice that metaphony of the original high-mid vowels has two different results, [i u] or, in open syllables inside nouns, the diphthongs [ei eu].

- (11) *Metaphony of low-mid vowels*
- | | | | |
|-------------------------|----|-------------------------|------------------|
| ['pɛ:ðə] 'foot' | vs | ['pi:ðə] 'feet' | |
| ['mɛ:sə] 'month' | vs | ['mi:sə] 'months' | |
| ['grɔssə] 'big.f.sg/pl' | vs | ['grussə] 'big.m.sg/pl' | <i>Cerchiara</i> |

⁴ An anonymous reviewer asks why low F1 is not captured as an element, although it is the property that metaphony manipulates. It is unclear to us if s/he is suggesting a solution or simply posing a problem. In this sense, naturally, the solution adopted in (10) is on our own responsibility.

Metaphony of high-mid vowels

['ve:rə] 'he.sees'	vs	['vi:rə] 'you.see'
['no:tʃə] 'walnut'	vs.	['nɔʊtʃə] 'walnuts'

Metaphony of low-mid vowels

['rɔssə] 'big.f'	vs	['russə] 'big.m'	
['peirə] 'foot'	vs	['pi:rə] 'feet'	<i>Cirigliano</i>

Metaphony of high-mid vowels

['kre:də] 'I.believe'	vs	['kri:də] 'you.believe'
['meisə] 'months'	vs	['me:sə] 'month'
['no:tʃə] 'walnut'	vs.	['neutʃə] 'walnuts'
['rɔmbə] 'I.break'	vs.	['rumbə] 'you.break'

Metaphony of low-mid vowels

['dɔrmə] 'I.sleep'	vs	['durmə] 'you.,sleep'	
['me:tə] 'I.reap'	vs	['mi:tə] 'you.reap'	<i>Stigliano</i>

In Lucanian, Apulian and North-Calabrian varieties the stressed nuclei present different outcomes according to the metrico-syllabic environment. This distribution is well known in the literature (cf. Rohlfs 1966 [1949]; Stehl 1980, 1988; Savoia 1987, 1990; Trumper 1987; Carosella 2005); recently, Savoia and Carpitelli (2008) and Savoia (2015) provide GP treatments. We can distinguish the outcomes occurring in what is conventionally named closed position, from those which occur in the so-called open position. Traditionally, this distinction is based on the difference between closed and open syllables that is between a rhyme including a consonant in coda and a rhyme devoid of coda. Moreover, in these varieties the antepenultimate stressed position of proparoxytones behaves as a closed context (Bafle 1996, 1999; Carosella 1998/99, 2005; Savoia and Carpitelli 2008; Savoia 2015). In other words, in these dialects, what we descriptively call 'closed contexts' include both the canonical contexts $_CC$ and the antepenultimate position in proparoxytones; the open contexts coincide with the traditional open syllable/rhyme environment $_CV\#$. The differentiation can involve both the duration and the quality of the stressed nuclei. Hence, in open contexts long vowels or diphthongs appear; on the contrary, in closed contexts shorter outcomes occur, namely [-ATR] in the case of high/mid vowels. For instance, in *Cirigliano*, *Stigliano* and *Accettura* varieties, the stressed [-ATR] outcomes, [a], [ɔ], [ɪ], occur in $_CC$ contexts and in the antepenultimate position of proparoxytones, as in (12b). In open contexts the alternant [ə:] is realized, as in (12a). In short, the [-ATR] mid vowels occur in closed contexts while in open contexts the corresponding [+ATR] long nuclei or diphthongs appear.

In *Cirigliano* variety, in stressed position [a] emerges in closed contexts, in the antepenultimate position included, as ['lattə] 'milk', ['lavənə] 'they wash',

while in __CV# contexts [ə:] occurs, as in [ˈsə:lə] ‘salt’. Similarly, low-mid outcomes occur only in __CC contexts and in the antepenultimate position. In open contexts we have diphthongs or closed vowels, as in (12a); in closed contexts the [-ATR] outcomes occur, as in (12b) where outcomes in proproxytones and in closed rhymes are compared. In *Accettura* (Lucania), we find a similar distribution. [a], [ɔ], [ɪ] occur only in __CC contexts and in the antepenultimate position, in (12a), while in open contexts the alternant [ə] is realized, in (12b). Analogously, the [-ATR] outcomes of mid vowels occur in closed contexts, in (12a) and the corresponding [+ATR] appear in the open contexts, in (12b). In *Stiglianese*, [a] is retained in all contexts; in open syllables the long high-mid vowels alternate with diphthongs, whereas in closed contexts the [-ATR] outcomes occur. It is of note that [i u] deriving from metaphony of low-mid original nuclei do not undergo this distribution. We find high [+ATR] outcomes regardless of the different contexts, although, as shown in (12c),⁵ in open position a long realization occurs.

(12)	a.	<i>open context/syllable</i>	b.	<i>closed context</i>	
		[ˈlə:və] ‘I.wash’		[ˈlavənə] ‘they.wash’	
		[ˈreirə] ‘I.laugh’		[ˈlattə] ‘milk’	
		[ˈve:rə] ‘he.sees’		[ˈrɪrənə] ‘they.laugh’	
		[ˈmo:və] ‘I.move’		[ˈpɪLLə] ‘I.take’	
		[ˈstoutə] ‘I.put out’		[ˈvɛrənə] ‘they.see’	
				[ʃʃellə] ‘wing/s’	
				[ˈmɔvənə] ‘they.move’	
				[ˈvɔkkə] ‘mouth’	
				[ˈstɔtənə] ‘they.put out’	
				[ˈkɔrtə] ‘short.m’	
	c.	[ˈpi:rə] ‘feet’		[ˈpɪrdə] ‘you.lose’	
		[ˈfu:kə] ‘fire’		[ˈuccə] ‘eye’	<i>Cirigliano</i>
	a.	<i>open context/syllable</i>	b.	<i>closed context</i>	
		[ˈlə:və] ‘I.wash’		[ˈlavənə] ‘they.wash’	
		[ˈve:də] ‘he.sees’		[ˈvrattə] ‘arm’	
		[ˈmo:rə] ‘he.dies’		[ˈvedənə] ‘they.see’	
		[ˈfrə:ʃə] ‘I.fry’		[ˈpɛʃʃə] ‘fish’	
				[ˈmɔrənə] ‘they.die’	
				[ˈdɔrmə] ‘I.sleep’	
				[ˈfrɪʃənə] ‘they.fry’	
				[ˈfɪʃjə] ‘son’	

⁵ The fact that metaphonic [i u] are not sensitive to the syllabic contexts recalls the blocking effect on the propagation triggered by metaphony (cf. Section 3). In both cases, the metaphonic outcomes do not interact with processes which could modify their internal melodic content, that corresponds, as we saw, to a specialized type of licensing inside the word.

The difference between the stressed vowel outcomes in the different metrical environment – open vs closed syllables – is well known in the literature. Open syllables tend to favour long [+ATR]/tense nuclei while closed syllables tend to favour lax short outcomes (Kaye, Lowenstamm and Vergnaud 1985, 1990; Féry 2001). According to Kaye, Lowenstamm and Vergnaud (1985, 1990) the vowel that governs a recessive position inside the nucleus (open syllable), basically has an unmarked vocalic content, excluding the [-ATR] outcomes [ɪ ɛ ʊ ə]. As for closed syllables, Kaye, Lowenstamm and Vergnaud (1990) conclude that ‘tense/lax alternation following rhyme structure is not a case of closed syllables laxing but merely the absence of tensing (i.e. no association of the ATR element)’. In other words, we can expect that in closed syllables the [-ATR] outcomes occur, while in open syllables the vowels of the fundamental triangle [i a u] (Jakobson 1968) are the preferred or tendential targets.

In the light of the preceding considerations, stressed [ə:], as the realization of original *a, i, u*, in open syllables, in (12), is unexpected. Indeed, if [ə] is conceived as an intrinsically lax segment, we meet with a generalized lax outcome in a position generally devoted to [+ATR] segments. If we assume that the property characterizing [ə] is [F1], its occurrence is no longer problematic. In fact, the element [F1] is a good candidate for the characterization of the melodic content of [ə] (cf. discussion around (39)). As a consequence, insofar as [F1] is interpreted as the aperture degree (low-frequency F1) associated to the [i u] members of the fundamental triangle, [ə] can be thought as a possible open rhyme realization. More precisely, we conclude that the open rhymes select specialized resonance configurations that optimize the fundamental vocalic properties, so including [F1].

Finally consider propagation.⁶ The traditional term ‘propagation’ refers to the assimilation process (descriptively, left-to-right) in which a stressed unrounded vowel hosts a rounded back vocalic element [u]/[w] occurring in the pre-tonic context. In other words, the cavity properties of a pre-tonic vowel are doubled within the immediate domain of the stressed nucleus or, in some grammars, also of the pre-tonic [a]. Propagation is operating in many Italo-Southern varieties, specifically in Abruzzese, Lucanian, North-Calabrian and Sicilian varieties. It has been documented and described in Lombardo (1901), Rohlfs (1966 [1949]), Piccillo (1971), Tuttle (1985), Mocciaro (1978), Savoia (1987, 2015), Schirru (2008, 2013, 2014).

The pattern of propagation can be summarized as follows:

⁶ We use the term ‘propagation’/‘spreading’ in a descriptive sense. We analyse propagation as a process in which the stressed nucleus (or another possible host) realizes some properties of a preceding vowel in its prosodic domain.

(14)

- i. Propagation of [u] from a pre-tonic position affects the immediately following stressed vowel, except the back rounded vowels.
- ii. In some dialects, a complex nucleus or a vocalic sequence is formed independently of the structure of the syllable, in others a back rounded vowel is realized.
- iii. In some dialects intermediate [ə]s are transparent, so allowing propagation to skip them and to reach the stressed nucleus (cf. the data of *Stigliano* in (17)).
- iv. In a subset of dialects it applies only on a stressed [a], excluding front vowels.
- v. In some dialects, also a following unstressed [a] can be targeted by propagation.
- vi. Propagation generally does not apply on front vowels resulting from metaphony; however, there are systems that do not obey this restriction, for instance the Lucanian variety of *Stigliano* in (17).
- vii. In a subset of varieties, propagation is sensitive to the place of articulation of the intervening consonant, as in the systems we analyse in this article.
- viii. The process applies both inside the word domain and in phonosyntactic context.
- ix. Inside the word the process is triggered by a pre-tonic vowel in the lexical base that affects an adjacent stressed nucleus or [a].
- x. In phonosyntactic contexts, alternants emerge that involve the phonological realization of a word in different contexts.
- xi. In phonosyntactic contexts, the process is governed by the syntactic relation between target and trigger of propagation. The micro-variation that emerges is analysed in Rizzi and Savoia (1993) and Manzini and Savoia (2016).

A good example of generalized application of propagation is provided by the Calabrian variety of *Cerchiara* in (15), where the spreading of [u] creates sequences such as [uæ], and takes place both in open and in closed syllables, regardless of the nature of the intermediate consonant. Word-internal contexts are illustrated in (15a), phonosyntactic contexts D-N in (15b) and phonosyntactic contexts Cl-V in (15c). Stressed nuclei different from [æ] may also be involved, cf. [uɛ] in (15b) or [ui] in (15c). The harmonic spreading does not take place on unstressed nuclei, cf. (15d). The outcome of metaphony does not undergo propagation, as in (15e). In (16) the spectrograms of the pair [u 'nuæ:sə] 'the nose' vs [næ:sə] 'nose' provide a visible analysis of the occurrence of [u] in the propagation context.

- | | | | | | |
|------|----|---------------|----------------|----|----------------|
| (15) | a. | [fuku'ɣuæ:rə] | 'hearth' | | |
| | | [pur'tuæ:βə]/ | '(I) brought/' | | |
| | | [pur'tuæ:mmə] | (we) brought' | | |
| | b. | [u 'nuæ:sə] | 'the nose' | b' | [næ:sə] 'nose' |
| | | [u 'puɛ:ðə] | 'the foot' | | |

- | | | | | | |
|----|------------------|----------------------|-----|----------------|-------------------------|
| c. | [m u 'ðuæjə] | ‘(you) me it give’ | c’. | [kə mə 'ðæɹjə] | ‘what (you) me give?’ |
| | [u 'fuættəsə] | ‘(I) it do’ | | [a 'fættəsə] | ‘(I) it(f) do’ |
| | [t u 'ðuitʃənə] | ‘(they) you it tell’ | | [t a 'ðitʃənə] | ‘(they) you it(f) tell’ |
| d. | [u kat'tʃæɪsəsə] | ‘(you) it chased’ | | | |
| e. | [ku'tʃi:mə] | ‘(we) cook’ | | | |
| | [u 'pittənə] | ‘the comb’ | | | |

Cerchiara

(16)

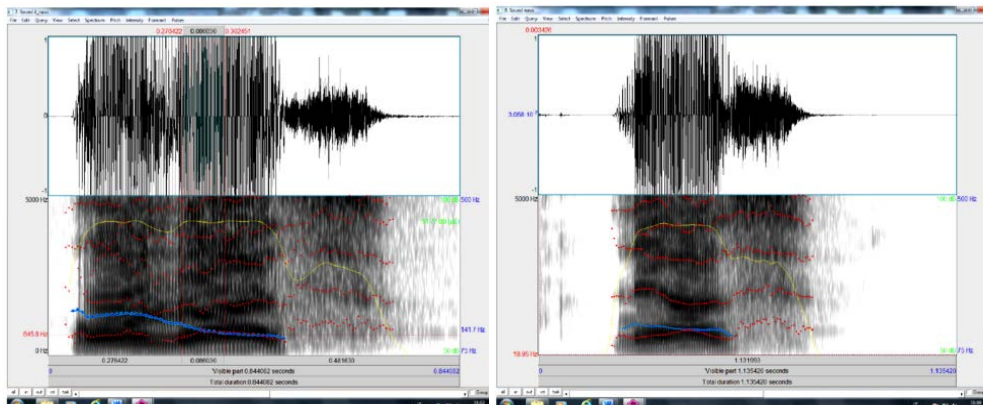

[u n u æ s ə]

[n æ: s ə]

Cerchiara

In some varieties, propagation applies also on a pre-tonic [a] and on the outcomes of metaphony, as in *Stigliano* variety (Lucania) (see Section 3). (17a) illustrates propagation on pre-tonic [a] and (17b) propagation on the outcome [i] from metaphony of low-mid underlying vowels. Comparative data in the right column show the non-propagated forms.

- | | | | | | | |
|------|----|----------------|----------------------|----|---------------|----------------------|
| (17) | a. | [lə trɔ'pɛ:ðə] | ‘the tripod’ | vs | [tra'pɛ:ðə] | ‘tripod’ |
| | | [lə fɔr're:jə] | ‘it.m I.would do’ | vs | [far're:jə] | ‘I.would do’ |
| | b. | [lə 'lui:və] | ‘it.m you.take away’ | vs | [la 'li:və] | ‘it.f you.take away’ |
| | | [lə kwɔ'nɔskə] | ‘him I.know’ | vs | [la ka'nɔskə] | ‘her I.knowz’ |

Stigliano

The fact that the pre-tonic nuclei can admit propagation poses an interesting question. In other words, propagation gets together stressed nuclei and unstressed pre-tonic [a] suggesting a subtler interpretation of the properties necessary for

licensing. We must think that [a] shares a cluster of basic properties with a stressed vowel, specifically a well-defined and stable resonance configuration endowed with a high degree of perceptibility, similar to the properties that characterize the stressed nuclei. In other words, the status of the prosodic head (stressed nucleus) is only a product of the phonetic properties of duration, sonority/aperture and perceptibility. These properties are present in [a] enough to characterize it as a licensing nucleus.

The restriction whereby the process does not apply in correspondence of the metaphonic outcomes [i(:)]/[iə] generally holds in propagation, although it is not obligatory, as the data of *Stigliano* variety in (17) (Savoia 1987) attest. This incompatibility could be connected with the competition between metaphony and propagation in order to generate the optimal output,⁷ and recalls the Strict Cycle Condition discussed in Kiparsky (1985). This condition forbids a rule which is applicable in a cycle to apply in the next cycle. In this perspective, metaphony can be seen as a word internal process that precedes/is ordered before propagation, although, however, propagation can apply inside the word as well. Moreover, there are dialects altogether similar to the ones here examined, in which propagation influences also the metaphonic outcomes. In other words, dialects with equal properties vary in presenting different solutions: propagation can or cannot apply to the metaphony outcomes. This suggests that a more substantial factor is operating, concerning the fact that, at least in the majority of systems, metaphony entirely subsumes/externalizes licensing properties of the stressed nucleus. So it excludes the externalization of the licensing triggered by propagation.

3. Propagation in some Lucanian varieties. The data and a first GP analysis

In what follows we will concentrate on propagation in the Central Lucanian varieties spoken in *Gorgoglione* and *Cirigliano*, where spreading of [u] is admitted only if the intermediate consonant, i.e. the consonant separating the two involved nuclei, is labial or velar, as already highlighted in Savoia (1987)⁸. The (phonological content of) pre-tonic [u] occurring in internal position of word or in the final position of clitics and determiners is copied on the first full (phonetically unreduced) unrounded vowel, i.e., a stressed front vowel or a stressed/pre-tonic [a]. More precisely, the result of propaga-

⁷ Rule interaction is a classical issue in phonological theory since its first formulations. In general, the application of a rule can feed or bleed another rule (Kenstowicz and Kisseberth 1979; Kiparsky 1982). The point under discussion is that while creating a context available to propagation itself metaphony can bleed propagation.

⁸ A similar distribution of propagation is documented also in other varieties; for example, it characterizes the Central Italian dialect of Terelle (Valle di Comino) examined in Schirru (2013).

tion is the occurrence of [w]/[u] in pre-vocalic position, indifferently in closed position and in open syllable.

Consider first the data of *Cirigliano* in (18). (18a,a',a'') illustrate the contexts where an intermediate velar or labial allows propagation to apply. An intermediate coronal or palatal/palato-alveolar consonant blocks propagation, as in (18b,b'). It is of note that in these varieties in the unstressed positions the vowels convert to [ə] while the rounded vowels convert to [u], as in the alternations in (18a''); [a] is preserved in pre-tonic position, while in post-tonic position it converts to [ə] as well. As we have seen in (12) the aperture degree of the stressed mid vowels depends on the metrical structure, whereby outcomes [+ATR] or diphthongs occur in open contexts, while [-ATR] outcomes occur in closed contexts. In the dialect of *Cirigliano* stressed [ə] corresponds to the realization of /a/ in open contexts, in (18b,b',b''); in the contexts triggering assimilation the realization [o] occurs, as in [fu'kwo:mə] 'we play', as in (18a').

(18)	a.	[u 'pweirə]	'the foot'	b.	[u 'rɪftə]	'the finger'
		[u 'fwɛrmə]	'him I.stop'		[fu'ʃeimə]	'we.escape'
		[s u 'mwandʒənə]	'themselves they.eat'		[nu'tʃɛllə]	'hazelnut'
					[u 'lattə]	'the milk'
					[u 'sə:lə]	'the salt'
					[u 'nə:sə]	'the nose'
					[u 'lɛ:və]	'it I.wash'
	a'.	[u s'kwo:rə]	'he.combs his hair'	b'.	[sə s'kə:rə]	'he.combs his own hair'
		[u 'fwo:jə]	'it you.make'		[a 'fə:jə]	'her you.make'
		[u 'kwo:sə]	'the cheese'		['kə:sə]	'cheese'
	a''.	['rɛmə]/[ru'r'mwɛmmə]	'I.sleep/we.slept'	b''.	[pur'tə:mə]	'we.bring'
		['rɛmbə]/[rum'bweimə]	'I.break/we.break'		[stu'tə:mə]	'we.put out'
		['foumə]/[fu'mwo:mə]	'I.smoke/we.smoke'			
		['fu:kə]/[fukwa'rillə]	'fire/small fire'			
		['fo:kə]/[fu'kwo:mə]	'I.play/we.play'			
		[mə 'kɔlkə]/[nə kul'kwomə]	'I.lie down/we.lie down'			
		[u mwar'tillə]	'the hammer'			

Cirigliano

In *Gorgoglione*, we find a similar distribution. (19a) illustrates propagation in some phonosyntactic contexts; (19a') exemplifies word internal propagation. (19b) shows the contexts in which an intermediate coronal or palatal obstruent disallows

propagation, both in phonosyntactic and word internal contexts. Finally (19c) exemplifies propagation on a pre-tonic [a]. In the examples, the diphthong [ɛ] is the outcome from an underlying /a/ in open contexts, as in (19b, b',b").

- | | | | | |
|------|-----|--|----|---|
| (19) | a. | [u 'mwɛttə] 'it I.put'
[u 'pwe:ðə] 'the foot'
[u 'fwɛrmə] 'it I.stop'
[nu 'fwɪλλə] 'a son'
[u 'kwɛʋsə] 'the cheese'
[u 'mwannə] 'it he.sends' | b. | [u 'dɪftə] 'the finger'
[u 'nɛʋsə] 'the nose'
[u lattə] 'the milk'
[u 'sɛʋlə] 'the salt'
[pu'r'tɛʋmə] 'we.bring'
[stu'tɛʋmə] 'we.put out'
[ku'tʃɪ:mə] 'we.cook' |
| | a'. | [fɪ:mə]/[fɪ'mwɛʋmə] 'I.smoke/we.smoke'
[rɔmbə]/[rum'bwi:jə] 'I break/I.broke'
[ʃo:kə]/[fɪ'kwammə] 'I.play/we.played' | | |
| | c. | [u kwa'nɔskə] 'it I.know'
[u mwar'tiəllə] 'the hammer' | | <i>Gorgoglione</i> |

A necessary requirement for the process to apply is that the consonant and the vowel hosting [w] must be adjacent. [r] in a second position of onset, interpolating between the labial/dorso-velar consonant and the vowel, generally blocks propagation, even if not obligatorily, as in (20b). On the contrary, a coda in the preceding syllable has no effect on the process, as in (20a). Finally, propagation does not apply to the metaphonic outcomes [i] (< *iə) in *Cirigliano* and [iə] in *Gorgoglione*, as in (20c).

- | | | | | |
|------|----|--|--|--------------------|
| (20) | a. | ['rɔrmə]/[rur'mwejə]
[mə 'kɔlkə]/[nə kul'kwomə] | 'I.sleep/I.slept'
'I.liedown/we.lie down' | |
| | b. | [u 'frə:tə]
[u 'pɹɛutə]
[u 'frɛi:fə]/[u 'frweifə] | 'the brother'
'the priest'
'it I.fry' | |
| | c. | [u 'fɪrrə]
[u 'pirdə] | 'the iron'
'it you.lose' | <i>Cirigliano</i> |
| | a. | ['dɔrmə]/[dur'mwi:mə] | 'I.sleep/we.sleep' | |
| | b. | [u 'frɛʋtə]
[u 'pri:mə]
[u 'fri:fə]
[u kra'pɛttə] | 'the brother'
'it we.open'
'it I.fry'
'the kid' | |
| | c. | [u 'fɪərrə]
[u 'fɪələ]
[u 'miəttə] | 'the iron'
'the thread'
'it you.put' | <i>Gorgoglione</i> |

If the intermediate consonant is a labial or velar approximant [v ɣ], the result is the glide [w] realized in onset, as in (21).

- (21) a. [u 'we:ʃə] 'him I.see' b. [a 've:ʃə] 'her I.see'
 [u 'waccə] 'him I.find' [a 'ɣaccə] 'her I.find' *Cirigliano*
- a. [u 'weddə] 'him I.saw' b. [a 'veddə] 'her I.saw'
 [u 'wattə] 'the cat' [ɔ 'ɣattə] 'the cats' *Gorgoglione*

The sensitivity to [u] is shared by labials [p b f v] and velars [k g ɣ]. In classical hierarchical models (Clements 1993; Clements and Hume 1995), labials and velars belong to different natural classes; labials are specified by the feature [labial], while velars by the feature [back/dorsal]. Coronals block the harmonizing process, in spite of being traditionally dealt with as consonants transparent to the vocalic harmonies. In the literature, proposals have been discussed that capture the relation between velars and labials, independently attested by a number of phenomena. Specifically, in the Jakobsonian model (Jakobson, Fant and Halle 1952; Jakobson 1971) the contrast grave/acute differentiates the segments characterized by a predominating lower side of the spectrum (grave) from those with a predominating upper side (acute). The grave segments are peripheral (velars, labials) with a larger and less comparted mouth cavity than that of the palatal and coronal segments (acute). Hence, [+grave] puts together labials and velars as sharing a low frequency configuration. The recourse to the feature [+grave] has been proposed to account for propagation phenomena like those we consider here, sensitive to the articulation place of the intermediate consonant (Savoia 1987; Loporcaro 2001; Schirru 2013).⁹

Suppose that the process can be understood as a V-C phenomenon whereby the vowel properties [labial, dorsal] take into account the place properties of the following consonant. Nevertheless, we cannot exclude a role for the following vowel that is affected by the propagation, as in the case of the [o] realization in *Cirigliano* in (18). Indeed, the properties of the following vowel control spreading of [u], which applies if this vowel is a stressed unrounded vowel or the low vowel [a]. Moreover, a metaphonic outcome can exclude propagation. Although we assign to the consonant a crucial role in the propagation, it is evident that it is [u] which contains the two relevant properties [round] and [back] able to select the consonantal context. What we want to say is that the spreading of [u] is driven by its cavity properties that search possible hosts where they can be licensed also by virtue of a corresponding property in the intermediate consonant.

In terms of the standard GP model, the tendential exclusion of the process if the intermediate onset is branching, i.e. including a velar or labial obstru-

⁹ The feature [+/-grave] is adopted by Schirru (2013) for capturing the contrast between the velar and labial consonants, admitting propagation of *u*, as in [λə kwənə] 'the dog'/[nə fwattə] 'a fact', and the coronal consonants, that exclude propagation, as in [λə sjakkə] 'the sack', in the dialect of Terelle, in Comino Valley.

ent followed by [r], as in (20b), could confirm the idea that [w] is inserted in the second slot of the onset. This solution would seem to be confirmed by the fact that the insertion of [w] takes place also when the nuclei or the rhymes are branching (Savoia 2015). In these contexts GP would exclude extra material inside the rhyme. Consider now the intermediate consonants. In the Element Theory framework, Harris and Lindsey (1995, 2000) and Harris (1994) assign the [U] component to labials and the resonance element [ə] to velars. Coronals are characterized by a specialized resonance property excluding a complex content. By virtue of this analysis, only labials would share the element [U] with the propagating vowel. Backley (2011), taking into account the processes that deal with velars and labials in a uniform way, assigns both consonantal classes the element [U], corresponding to an acoustic structure with a dominant low side of the spectrum. Differently from velars, in labials, [U] has the role of head in the melodic expression. If we take it that [U] characterizes both velars and labials, propagation can be accounted for in a natural way. Indeed, the relation between velars and labials is no longer a consequence of different properties of [u] but corresponds to the real sharing of the resonance properties codified by the element [U] in consonants.

Following the GP framework, [U] spreading can be depicted as in (23a,b) where the domain of the stressed nucleus shares the melodic content with the pre-tonic vowel. Spreading is the result of the constraint in (22), requiring that [u] in a pre-tonic position is admitted if [U] is realized in the domain of the stressed nucleus (Savoia in press a). [U] associates to the second position of the onset in (23a). In the case of the assimilation of [ə] to [o] in (23b) the element [U] is shared with the stressed vowel. If we interpret [ə] as a non-headed configuration including the element [A], assimilation can be treated as the result of propagation of [U], whereby the stressed nucleus subsumes this specification.

- (22) [U] in the pre-tonic nucleus is licensed by [U] associated to the onset consonant in the immediate domain of the stressed nucleus or a pre-tonic [A].

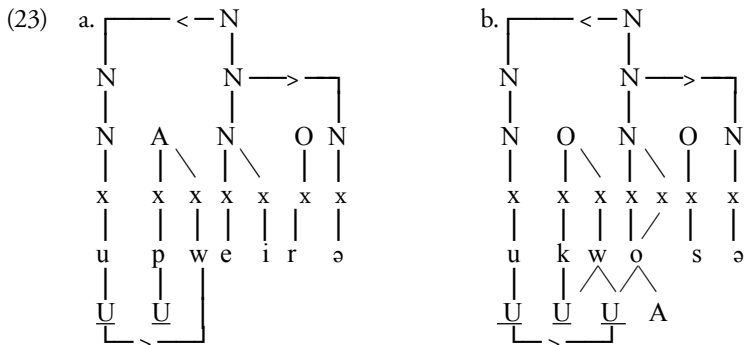

Cirigliano

In these varieties, intervocalic [v y] are realized as approximants coinciding with the only resonance property [U], as in (21a). According to Kaye, Lowenstamm and Vergnaud (1985, 1990), these segments lack the consonantal properties necessary to license a complex onset. This fits in with the fact that they do not subsume a second element. In the presence of initial [y] or [w] all it is necessary for satisfying the assimilatory process, is that [U] is shared by pre-tonic vowel and initial approximant. In both cases, the element [U] is legitimized in the domain of the stressed nucleus.

3.1 *A minimalist analysis of propagation*

We can restate the analysis in (23) in the terms of the approach proposed in Section 1. If we consider generalized propagation in *Cerchiana* in (15), the representation in (24) is adequate, in which a rising diphthong is formed through inserting [u] in the nuclear space of the stressed vowel. The harmonizing effect ratifies licensing in its domain. The consonant content is transparent to harmony, which only requires that [u] in pre-tonic position be licensed by [u] in stressed position.

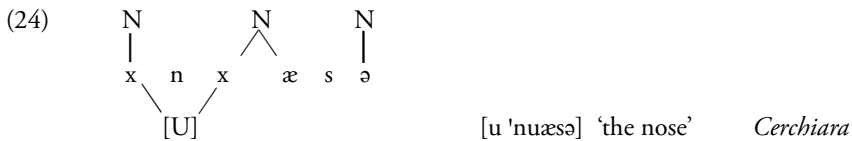

Pass now to the Lucanian varieties where the intermediate consonant contributes to licensing of [u]. The reduced notion of structure we adopt allows us to treat this mechanism in a simple and natural way, unlike models providing rich and rigid structural representations. Specifically, no clear formal way for capturing the relation between the onset, the trigger of propagation and the stressed nucleus is provided by GP. In fact, the onset has no direct licensing relation with a pre-tonic nucleus, considering that in GP the onsets are not in the immediate domain of the nucleus and that nuclei form a special tier regulating harmonizing/propagation. In short, it is not evident by virtue of what structural principle the velar/labial onset interacts with the [U] propagation from the pre-tonic vowel.

In (25b), [u]/[w] inside the domain of the stressed nucleus satisfy the requirement whereby the occurrence of [U] in the preceding vowel must be licensed, according to (22) now reformulated into (25a). In these dialects the stressed nucleus legitimizes [u] by virtue of the agreement with [U] in the intermediate velar or labial consonant. More precisely, licensing exploits [U] in the adjacent consonant; hence, velars and labials contribute to interpreting [U] in the domain of the stressed nucleus. A simpler type of assimilation is instantiated by the contexts in (21), where an intermediate velar or labial

approximant changes to [w]. In (25c) this type of assimilation is analysed, where licensing is implemented by [U] associated to the intermediate position. We can connect the shift to a glide reading of the intermediate [U] with the fact that the [U] element is interpreted entirely inside the nuclear domain, where it is treated as the onglide of a sequence *onglide-long vowel*. This realization satisfies licensing in that it interprets [U] in the domain of the stressed nucleus, as in (25b), and at once it preserves/manifests the [U] content of the intermediate element.

- (25) a. [U] in the pre-tonic nucleus is licensed by [U] present in the domain of the stressed nucleus and in the intermediate consonant (essentially, in all segments of the relevant domain)

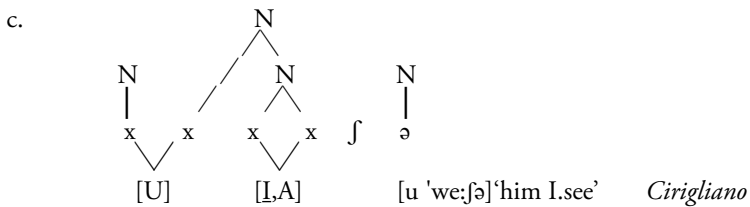
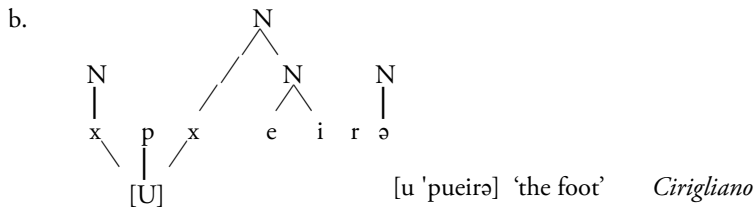

In the processes where [u]/[w] are propagated or preserved (cf. Section 5) by virtue of an adjacent velar (or labial), [u]/[w] manifest the licensing relation.¹⁰ The stressed or full nucleus takes in this domain the cavity content of the pre-tonic vowel exploiting the corresponding cavity property of the adjacent consonant. Licensing can be understood as nothing but the assimilatory mechanism.

Propagation in the *Stigliano* dialect introduces interesting clues as regards the relation between the propagating element [U], the adjacent consonant and the target nucleus. In this variety, the harmonic spreading affects all stressed vowels and also pre-tonic [a]. It is of note that in the *Stigliano* variety the original /u/ in pre-tonic position is generally realized as [ə] (cf. the discussion in section 6). However, this neutralization is variably realized, in the sense

¹⁰ It is of note that in (25b,c) an onglide-head-offglide sequence is created, similar to the ones discussed in Pöchtrager (2015) for Chinese. Our treatment can be compared with the solution of Pöchtrager, insofar as it assumes a projection comprising one head preceded and followed by a licensed position.

that in pre-tonic contexts of propagation the short lax [ʊ] can be heard. In the large transcription in (26) we have left out this indication.

The data in (26), display word-internal contexts and phonosyntactic contexts D-N and Cl-V respectively. The presence of [ə] between the trigger of the harmony and the stressed nucleus does not block spreading, as in (26h). The outcomes of the harmony for stressed /a/ are [ɔ:], in (26a), [wɔ:] following a velar consonant in open syllables, in (26b), and [wa] in closed syllables, in (26c). For pre-tonic [a] we find the same outcomes, i.e. [wɔ] after a velar consonant in open syllables, in (26d), [wa] in closed syllables, in (26e), and [ɔ] in the other contexts, in (26f). For the other stressed vowels, we find the simple insertion of a [w]/[u] segment, in (26g); the outcomes of metaphony may also be affected (cf. (17b)). We note that in this variety pre-tonic /u/, final positions of clitics and articles included, neutralizes to [ə]. We assume that in underlying representations the specification [U], associated to the masculine singular D and the masculine singular accusative Cl, triggers the process. Finally (26i) illustrates the alternations affecting the initial approximants [v ʏ] that in propagation contexts are replaced by [w], as in (21). In the column on the right, the alternants with the lexical vowel are provided.

(26)	a.	[kən'dɔ:və] 'I.sang' [lə 'nɔ:sə] 'the nose' [lə 'fɔ:jə] 'it.m you.do'	a'.	['kɔndə] 'I.sing' ['na:sə] 'nose' [la 'fa:jə] 'it.f you.do'
	b.	[nə kəl'kwɔmə] 'we.lie down' [lə 'kwɔnə] 'the dog' [lə 'skwɔrə] 'it.m I.comb'	b'.	[mə 'kɔlkə] 'I.lie down' ['ka:nə] 'dog' ['ska:rə] 'I.comb'
	c.	[addəm'mwənnə] 'I.ask' [lə 'lwəskwə] 'him I.leave'	c'.	[lə 'kwəmbə] 'the field' [la 'ləskwə] 'her I.leave'
	d.	[fukwɔ'riddə] 'little fire' [lə kwɔ'nɔskə] 'him I.know'	d'.	['fu:kə] 'fire' [la ka'nɔskə] 'her I.know'
	e.	[lə kwat'tʃa:mə] 'it we.take out'	e'.	[kat'tʃa:mə] 'we.take out'
	f.	[lə mɔr'tiddə] 'the hammer' [lə sɔl'va:mə] 'him we.save' [lə sɔ'peimə] 'it.m we.know'		[mar'tiddə] 'hammer' [la sal'va:mə] 'her we.save' [sa'peimə] 'we.know'
	g.	[nə'tʃwɛddə] 'nut-dimin' [lə 'dwiʃtə] 'the finger'	g'.	['neutʃə] 'nut' ['dʃtə] 'finger'
	h.	[lə də'vɔ:kə] 'it.m I.empty'	h'.	[la də'va:kə] 'it.f I.empty'
	i.	[lə 'weivə] 'it I.drink'	i'.	[la 'veivə] 'it.f.drink' <i>Stigliano</i>

The data in (26) show that also in *Stigliano*, propagation is sensitive to the velar articulation of the intermediate consonant. A velar obstruent between [U] and [a] induces a double realization of [U], which occurs as [w] after the consonant and as the vocalic velarized outcome [ɔ]. The data of *Stigliano* witness also the possibility that licensing can be entirely subsumed by the nucleus. Indeed, the [ɔ] outcome can legitimize [U] in the preceding vocalic

slot without that [w] is independently required, as in (27a). In the contexts *kaCV...* we find two copies of [U], one on the vowel, that converts to [ɔ], and the other one as [w] between *k* and *ɔ*, as in (27b).

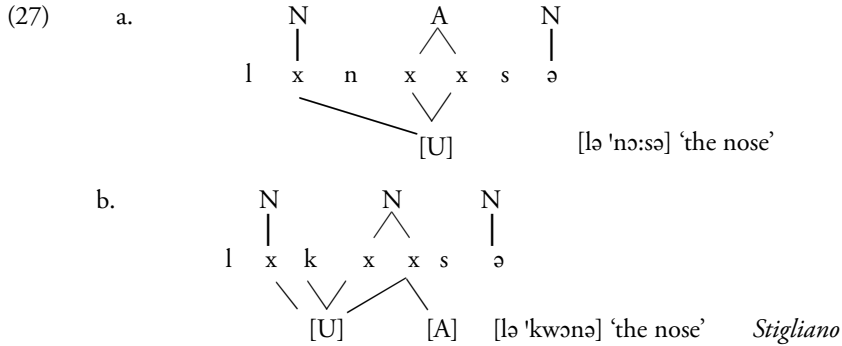

The arrangement in (27b) confirms the idea that the nucleus is independently active in legitimizing [U]. In fact, also in the contexts with a velar obstruent that in turn attracts [w], [a] can implement licensing by realizing the harmonic result [ɔ]. As in the case of *Cirigliano* in (25b) the [w] glide legitimized by the velar obstruent expresses the relation between the (stressed/[a]) nucleus and the consonant in its domain. Specifically, in *Stiglianese* the intermediate velar manifests the assimilation with pre-tonic vowel only if the nucleus interprets [U] in its turn by means of the velarized realization [ɔ].

In *Stigliano* dialect propagation applies even if between the harmonizing trigger and the stressed nucleus one or more [ə]s occur, as in (26h). This possibility implies a further parameter, connecting propagation to classical harmonies (Demirdache 1988). In this dialect, the application does not require adjacency between the triggering nucleus and the hosting nucleus. Moreover, relaxing adjacency is constrained by the melodic content of intervening vowels that need be devoid of any place specification. In other words, we can assign to the central vowel [ə] the simple content coinciding with the formantic element [F1] adopted in (10) (see discussion in section 6.1). The requirement whereby it is the stressed nucleus or pre-tonic [a] that attract [U], is valid; however, intervening [ə]s are not interpreted by propagation, that takes into account only nuclei introducing a specific cavity configuration [U], [I], [A]. As suggested in (28), [F1] is out of the scope of propagation that instead is hosted within the long stressed nucleus.

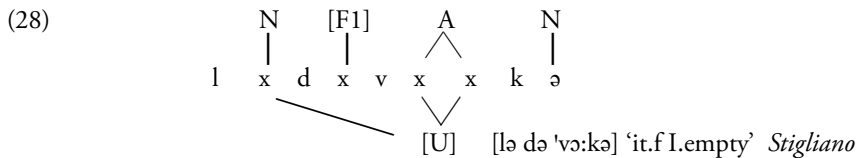

Before concluding the analysis of propagation it is interesting to note that propagation systematically applies in derivational contexts and in enclitic imperative contexts. The examples of diminutive form are repeated in (29). Naturally, given the word internal nature of diminutive morphology (or other derivational morphemes), the process applies exactly as in the other word internal domains.

- | | | | | | |
|------|----|--|----|--|-------------------|
| (29) | a. | [fɔkwə'riddə] 'little fire'
[nə'tʃwɛddə] 'nut-dimin.'
[ɔrtə'tʃwiddə] 'little garden' | b. | ['fu:kə] 'fire'
['neutʃə] 'nut'
['urtə] 'garden' | <i>Stigliano</i> |
| | | [fukwə'rillə] 'little fire'
[vukkwa'rɛllə] 'small mouth'
[ɣul'pwaccə] 'little fox' | | ['fu:kə] 'fire'
['vɔkkə] 'mouth'
['ɣɔlpə] 'fox' | <i>Cirigliano</i> |

A different morphosyntactic status characterizes the enlarged domains where the enclitics adjoin to the verbal base, as in imperatives. Also in these contexts, propagation is triggered, as in (30b). In these dialects, enclisis to the imperative determines the stress shift to the final vowel of the verb. It is of note that in the examples in (30b) the stressed vowel preceding the enclitic is not a part of the clitic but coincides with the thematic vowel of the verbal lexical entry. This segmentation is confirmed by the fact that the quality of the vowel varies according to the verbal class, i.e. /-a-/ (realized as [ɔ] in *Stigliano* and [o] in *Cirigliano*) in the first conjugation and *-ei-* in the second/third conjugation.

- | | | | | | |
|------|----|---|----|---|-------------------|
| (30) | a. | ['tukkə 'kɔstə] 'touch this!'
['kundə 'kɔstə] 'count this!'
['rumbə 'kɔstə] 'break this!'
['keutʃə 'kɔstə] 'cook this' | b. | [tɔk'kwɔ-lə] 'touch it!'
[kɔn'dwɔ-lə] 'count it!'
[rɔm'bwei-lə] 'break it!'
[kɔ'tʃwei-lə] 'cook it!' | <i>Stigliano</i> |
| | | ['tukkə 'kɔllə] 'touch that!'
['kundə 'tɔttə 'kɔ:sə] 'count all things!'
['ruppə] 'break!' | | [tɔk'kwo-lə] 'touch it!'
[kɔn'dwo-lə] 'count it!'
[rup'pwei-lə] 'break it!' | <i>Cirigliano</i> |

We follow the proposal in Manzini and Savoia (submitted) whereby the stress reassignment is due to specialized phonological/metrical properties that lexicalize the interpretive properties of enclitics. More precisely, a 'prosodic feature [FOOT]' associated to the lexical entry of the clitic fixes stress assignment, as in (31a). The enclitics trigger a domain in which the stressed nucleus licenses a weak nucleus on its right, giving rise to the sequence in (31b).

- (31) a. [FOOT]: Construct a binary left-headed domain that includes the last vowel of the postlexical string. (from Manzini and Savoia, submitted)

velar. In the first case **l* changed to a velar outcome of the type of [u], while in the other context the lateral is preserved or, in many dialects, for instance *Senise*, has changed to [r].

(32) i.	<i>*l-coronal/palato-alveolar</i> [aut]/['auta] 'high.m/f' [ku'tɛl] 'knife' [kaut]/['kauda] 'hot.m/f' [kau'dɛra] 'boiler' [i 'ausu] 'I.lift' [kaus] 'kick'	ii.	<i>*l-labial/velar</i> [vu:lɔ] 'fox' [ku:lɔ] 'blow' [bal'kuŋ] 'balcony' [su:lɔ] 'furrow'	<i>Lèssolo</i>
	['kaβəðə] 'hot.m' ['ɣaβətə] 'high.m' [mə 'ɣaβətsə] 'I.stand.up'		['vurpə] 'fox' [tə 'kurkə] 'you.lie down'	<i>Cassano</i>
	['ɣautə] 'high.m' ['kaurə] 'hot.m' ['kautʃə] 'kick' ['fautʃə] 'scythe'		['ɣɔlpə] 'fox' ['palmə] 'palm' [mə 'kɔlkə] 'I.lie down' ['sɔlkə] 'furrow'	<i>Cirigliano</i>
	['ɣautə] 'high.m' ['kaurə] 'hot.m' ['kautsə] 'pants' ['fautʃə] 'scythe'		['ɣurpə] 'fox' ['surkə] 'furrow' [bar'kɔ:nə] 'balcony'	<i>Senise</i>

A reasonable conjecture is that the original **l* first changed to a velarized lateral [ɮ] before coronals and palato-alveolars and then to a vocalic element [u]. Hence, labials and velars share a property that blocks velarization and vocalization. A possible line of explanation is that velarization before velar and labial obstruent is prevented by virtue of OCP (Obligatory Contour Principle; Leben 1973, 1978; Goldsmith 1990), whereby two adjacent identical elements (in this case [U]) on the same tier are forbidden, as suggested in (33). This should drive the lateral in coda to be retained in these contexts, and possibly to change to [r], as in *Senise* in (32). Anyway, we are induced to conclude that velars and labials actually have a common property that prevents the velarized liquid from changing to a vowel before these obstruents.¹¹

¹¹ An anonymous reviewer suggests that “an equally plausible scenario is where coronals promote vocalisation and labials and dorsals are simply the residue”. This solution would imply a different mechanism, based on dissimilation or strengthening of perceptual contrast between two adjacent positions.

ciating it to an adjacent velar onset, where the component [w] is anchored to the consonant. (35a)-(36a) illustrate the contexts where [w] propagates from the preceding unstressed vowel to the following stressed domain including a stressed nucleus deriving from *a. (35b)-(36b) show contexts where an unstressed /o u/ following a velar onset decomposes into the sequence [wə]. The same holds for post-tonic contexts in (35c)-(36c). It is of note that cases such as [ˈkɔlkə]/[kwəlˈkwə:mə] ‘I.lie down/we.lie down’ show a double realization of [w], corresponding to the two possible contexts triggering the realization of [w] on an adjacent [k] in pre-tonic contexts and in the stressed contexts.

In the system of *Accettura* the lexical level vowels /i a u/ in open syllable realize as [ə], cf. (36d.ii). The pair [ˈkwə:sə]/[ˈkʊsənə] ‘I.sew/they.sew’ in (36b) exemplifies the alternation between different realizations of the stressed underlying/lexical level /u/. As shown in Section 2, [ʊ] occurs in __CC and antepenultimate contexts, while [ə:] occurs in open contexts. This variety preserves the underlying specification [U] in the context of a velar onset by anchoring [w] on the velar onset as in (35a,b,c). In any case, we find a sequence [wə] that combines [U] with the realization [ə]. This sequence can arise from a lexical pre-tonic [u] preceded by [k], as in (36b), and in post-tonic position as in (36c). The second alternants in (36a) and (36b) such as [ʃəˈkwəmə] ‘we.play’ show the realizations [wə] created by propagation of pre-tonic lexical /u/ to the following stressed nucleus [ə] by anchoring to the intermediate velar. In other words, the [U] component of an /u/ adjacent to a velar onset realizes as [w] on the velar consonant, independently of whether it is in a stressed or unstressed domain, as in [ˈkwə:sə]/[ˈkwə:sə:mə] ‘I sew/we sew’. Hence, the system of *Accettura* is different from the one of *Ruvo* where the back vowel is preserved in stressed position, as in [ˈkɔ:ʃə]/[ˈkwəˈʃeimə] ‘I sew/we sew’ in (35b). The data in (35d)-(36d) exemplify the realizations of /a/ in the two varieties; so [a] occurs in open position, while, in closed position we find [ɔ:] in *Ruvo* and [ə:] in *Accettura*. (35d.ii)-(36d.ii) show that propagation is excluded in phono-syntactic contexts. (35d.iii)-(36d.iii) shows that a labial is unable to attract or preserve the element [U] of an adjacent [u]. Finally (36d.iv) shows that the occurrence of [k] is admitted independently of the presence of [w].

- (35) a. [ˈʃɔ:kə]/[ʃəˈkwəmə] ‘I.play/we.play’
 [ˈtʊɛkkənə]/[təkˈkwəmə] ‘I.touch/we.touch’
 b. [ˈkɔlkə]/[kwəlˈkwəmə] ‘I.lie down/we.lie down’
 [ˈkɔ:ʃə]/[kwəˈʃeimə] ‘I.sew/we.sew’
 [kwərˈtiddə]/[kwərˈtieddərə] ‘knife/knives’
 c. [ˈpikwərə] ‘sheep’, [ˈmueskwə] ‘fly/flys’
 d. i. [ˈnɔ:sə] ‘nose’ vs. [vrattəsə] ‘arm’
 ii. [ˈkɔ:nə]/[uˈkɔ:nə] ‘dog/the dog’
 iii. [ˈfeumə]/[fəˈmɔ:mə] ‘I.smoke/we.smoke’
 [ˈduɛrmə]/[drəmˈmeimə] ‘I.sleep/we.sleep’ *Ruvo*

- (36) a. ['ʃo:kə]/[ʃə'kwə:mə] 'I.play/we.play'
 ['təkəkə]/[tək'kwə:mə] 'I.touch/we.touch'
 b. ['kələkə]/[kwəl'kwə:mə] 'I.lie down/we.lie down'
 ['ko:tʃə]/[kwə'tʃə:mə] 'I.cook/we.cook'
 ['kwə:sə]/[kwə'sə:mə]/['kʊsənə] 'I.sew/we.sew/they.sew'
 ['kɔntə]/[kwən'də:mə] 'I.sing/we.sing'
 [fukwə'lə:rə] 'hearth', [kwər'tiddə] 'knife'
 c. ['ə:kwə] 'needle', [vɛ'kwə] 'I.see', ['dəkʷə] 'I.say'
 ['pikwərə] 'sheep', [fər'mekwələ] 'ant'
 d. i. ['nə:sə] 'nose' vs. ['yaddə] 'cock'
 ii. ['kə:nə]/[u'kə:nə] 'dog/the dog'
 iii. ['fə:mə]/[fə'mə:mə] 'I.smoke/we.smoke'
 iv. ['sɛkkə]/[sək'kə:mə] 'I.dry/we.dry' *Accettura*

In the varieties spoken in *Ruvo* and *Accettura*, also (underlying) back vowels realize as [ə] in unstressed position. A velar consonant in the onset, specifically [k], saves [U]. In *Accettura* dialect, this mechanism concerns also the stressed [ə:] deriving from an original *u* in open syllable. [U] propagates to the following syllable if the onset is [k] and the nucleus is a schwa, in *Accettura*, or 1st plural person *-ə-* in *Ruvo*. In the form [kwəl'kwəmə] 'we.lie down' of *Ruvo* in (37), both processes apply, namely propagation of [U] from pre-tonic slot and decomposition of /u/ to [wə] in the context *k__*. In (37) the sharing of the melodic content realizes the licensing process implemented in these sequences.

- (37)
- | | | | | | |
|-----|-----|---|-----|--------------|---------------|
| | N | | N | | N |
| | / \ | | / \ | | |
| k | x | ə | l | k | x |
| | / \ | | | / \ | |
| [U] | | | | [U] | |
| | | | | [kwəl'kwəmə] | 'we.lie down' |
- Ruvo*

In pre-tonic contexts, the nucleus [U] of the lexical base is retained in a weak position inside the metrical domain of the stressed nucleus, where its legitimization is favoured by sharing [U] with [k]. Given that the velar is involved in licensing only in the domain of [u] (see (36d.iv)), we must conclude that the agreement on [U] between the vowel and the consonant is able to implement licensing. In (37) [U] in pre-tonic position is interpreted in the domain of the stressed nucleus in contexts where [U] is anchored also on the adjacent consonant. This means that in a sequence such as the one in (37), two copies of [U] are realized, both saved by the adjacent velar. To sum up, the occurrence of [U] in pre-tonic and in stressed nucleus manifests the prosodic relation between segments in terms of phonetic agreement on some resonance property. The preservation allows [u] and [k] to have a more perceptually adequate output. This requirement is satisfied in all contexts where it is possible, i.e. when a velar is adjacent to [u] (Kaun 1995; Walker 2005; see discussion in 5).

A labial consonant is not involved, differently from what we have seen in the case of propagation discussed in Section 3. We can express this restriction by assuming that the element [U] involved is not the head, as suggested in the characterization of labials and velars presented in Section 3 (Backley 2011). We can think that the headedness is nothing but a contrastive property; in the case of labials and velars, [U] contrasts labials, where it is the place, with velars, where it specifies a resonance property not dependent on a labial place. Hence, varieties such as those of *Ruvo* and *Accettura* take into account only [U] as a resonance property affecting the spectral structure of the adjacent vowel. This excludes the place interpretation of [U].

Turn now to the contexts of *Accettura* in (36b) that show licensing independently of propagation. As noted, in the stressed contexts the sequence [wə] corresponds to an underlying /u/ in open position. The nucleus [ə] realizes the only element [A]. So, we must admit that the cavity element [A] is able by itself to introduce the stress properties (duration and intensity). The element [U], encoded in the lexical base, is interpreted as an autonomous segment inside the domain of the nucleus. The preceding [k], in turn legitimized by the stressed nucleus, contributes to interpreting [U] by sharing it, as in (38).

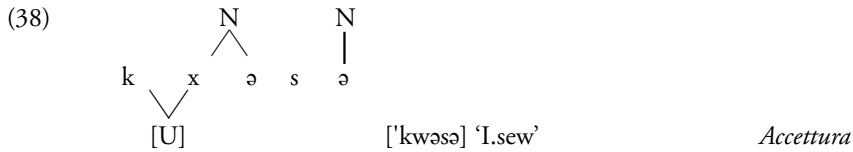

As mentioned in 2, some authors (cf. Clements and Hume 1995) proposed separating on different tiers consonantal and vowel place properties. Actually, phenomena of the type we have examined allow to conclude that this distinction is inadequate at least since it is unable to capture the interaction between consonants and vowels largely testified by harmonizing processes.

6. Preservation of pre-tonic [u] in the Apulian dialect of Corato

In many Southern Italian varieties, unstressed vowels are subject to a neutralization process that converts them to schwa except [a] which is preserved. Nevertheless, many dialects retain some of the properties of an original rounded back vowel, as we have seen for *Ruvo* and *Accettura*. In the Apulian variety of *Corato*, pre-tonic [u] adjacent to a velar consonant is systematically retained, as discussed in D'Introno and Weston (1997, 2002) and Bucci (2013).

The phonological system of *Corato*, just like the other Central Apulian and Lucanian varieties, is characterized by the contrast in duration and quality of stressed vowels according to whether they occur in open syllable or in

closed syllable/position (see Section 2). We remember that the open position is the context where the nucleus is followed by a simple consonant in turn preceding a nucleus; the closed position corresponds to the contexts where the nucleus is followed by a sequence of two consonantal slots or, in these dialects, it is in antepenultimate position. In open position, stressed vowel is branching, realizing as a long vowel or a falling diphthong. In closed position, stressed vowels are short and present specialized realizations. So, this contrast generally implies specialized cavity/aperture degree properties, as noted in D’Introno and Weston (1997, 2002). In *Corato* variety, the length contrast between stressed vowels in open and in closed contexts is signalled by means of duration, aperture degree and diphthongization. As for mid vowels, in open contexts we find high-mid outcomes (39a) or the falling diphthongs [ai au] (39b), while in closed contexts low-mid outcomes occur, as in (39c). High vowels are preserved in open contexts, as in (39e), while in closed contexts high-mid/high [-ATR] outcomes arise (39f). Analogously to the other dialects of its area, *Corato* dialect presents metaphony operating both on high mid and low mid vowels. In the first case, we find high outcomes (39g), in the second case the diphthongs [ie uo] occur (39h).

(39)	a.	[ˈpe:də] ‘foot’	[ˈno:və] ‘new.f.sg/pl’
	b.	[ˈmaisə] ‘month’	[ˈsaulə] ‘sun’
	c.	[ˈdɛʃʃətə] ‘fingers’	[ˈvɔkkə] ‘mouth’
	d.	[aˈtʃɛddərə] ‘birds’	[ˈɔccərə] ‘eyes’
	e.	[fərˈmi:kə] ‘ant’	[ˈku:sə] ‘I.sew’
	f.	[ˈfijjə] ‘son’	[ˈkɔsənə] ‘they.sew’
	g.	[ˈmi:sə] ‘months’	[ˈkɔrtə] ‘short.m.sg/pl’
	h.	[ˈpiedə] ‘feet’	[ˈnuovə] ‘new.m.sg/pl’

Corato

As a first step, in (40) we present the data illustrating the treatment of the pre-tonic vowels, that we gathered during a recent (2016) field investigation. Although these data essentially correspond to those of D’Introno and Weston, they add some interesting refinements. The examples in (40) concern bases with a rounded back vowel alternating between stressed and pre-tonic position where neutralization to [ə] could be expected, as in (40e). The data are subdivided according to the nature of the preceding or following consonant adjacent to lexical [ɔ o u]. So (40a) illustrates the alternation in the context where a velar onset precedes the rounded back vowel, which is retained and realized as [u]. (40b) illustrates the contexts where a velar onset follows the lexical rounded back vowel and propagation of [u] emerges on the following velar in similar terms to the ones observed for the *Ruvo* and *Accettura* dialects in (35a,b) and (36a,b). If the immediately preceding consonant is not velar, [ə] occurs, as in (40b’); preservation of [u] is not excluded, at least in the presence of a labial onset, like in (40b’). The presence of a labial preceding or

following the rounded back vowel does not induce retaining [u], as shown by the examples in (40c). The data in (40d) illustrate the fact that in the strings with an initial trochee the preservation of the rounded back vowel associated to the secondary word stress is favoured. In these contexts, preservation seems to be independent of the quality of the adjacent consonant, even though not obligatory as indicated by the cases in (40d'). In the case of bases with a front vowel preceding the main-stressed nucleus, [ə] is systematically found independently of the nature of the adjacent consonants, as in (40e').

- (40) a. ['ku:sə]/[ku'si:mə] 'I.sew/we.sew'
 ['kəndzə]/[kun'dza:mə] 'I.season/we.season'
 [s avvrə'gəŋŋə]/[n avvrəgəŋ'ja:mə] 'he.is ashamed/we.are ashamed'
 [arrə'kərdə]/[arrəkur'da:mə] 'I.remember/we.remember'
 ['kurtə]/[kurta'rieddə] 'short/a few short'
 ['skaupə]/[sku'pɛttə] 'broom/small broom'
- b. [mə 'kəkəkə]/[nə kuk'kwamə] 'I.lie down/we.lie down'
- b'. ['fo:kə]/[fə'kwamə] 'I.play/we.play'
 ['tsaukə]/[tsə'kwiddə] 'rope/small rope'
 ['məskwə]/[məs'kwiddə] 'fly/midge'
 [mbə'kwa] 'to hear'
- b''. ['vəkəkə]/[vuk'kɛddə] 'mouth/little mouth'
- c. ['pərtə]/[pər'ta:mə] 'I.bring/we.bring'
 [arrə'vəʃʃə]/[arrəvəʃ'ja:mə] 'I.cover/we.cover'
 ['fu:ʃə]/[fə'ʃi:mə] 'I.scape/we.scape'
 ['pu:tə]/[pə'ta:mə] 'I.prune/we.prune'
 ['mɔ:və]/[mə'vi:mə] 'I.move/we.move'
- d. ['kɔ:rə]/[kɔrə'tʃieddə] 'heart/small heart'
 ['vɔttə]/[vɔttə'tʃieddə] 'barrel/small barrel'
 ['uossə]/[əssə'tʃieddə] 'bone/small bone'
 ['əmənə]/[əmə'nieddə] 'man/little man'
 ['mənəkə]/[mə'nəkɛddə] 'nun/little nun'
- d'. ['juommərə]/[jəmə'rieddə] 'ball/small ball'
 [tʃə'pɔddə]/[tʃəpɔd'dɔttsə] 'onion/small onion'
- e. ['dɔrmə]/[dər'mi:mə] 'I.sleep/we.sleep'
 ['ro:tə]/[rə'tɛddə] 'while/small while'
 [rən'dzo:lə]/[rəndzə'lieddə] 'sheet/small sheet'
- e'. ['fɪʃʃə]/[fəʃʃa'rieddə] 'son/little son'
 [fər'mi:kə]/[fərmə'kɔddə] 'ant/little ant'
 ['prɛvətə]/[prəvə'ticcə] 'priest/little priest'
 ['pɛrdə]/[pər'di:mə] 'I.lose/we.lose'
- Corato*

The alternations in (40) show that [u] preservation in this variety is not substantially different from what we saw for the dialects of *Ruvo* and *Accettura* in (35)-(36). Again, an intermediate velar allows the rounded back

element [U] from the preceding /u/ to realize as [w], as in (40b'); this is the same process that applies in (35a) and (36a). Analogously, the preservation of pre-tonic [u] seems to be nothing but a variant of the phenomenon seen in (35b) and (36b), where however the content of [u] is decomposed in [w] and [ə].

D'Introno and Weston (1997, 2002) document [u] preservation also in labial contexts. In our data, this possibility emerges only in a residual and strongly variable modality (some degree of uncertainty is noted also by D'Introno and Weston 2002: fn. 2). We take it that [U] content of labials could be potentially able to determine the same alternations we saw for velars. In discussing the data of *Ruvo* and *Accettura* we have already noted that the element [U] that is involved in these licensing processes is not the head. The headed [U] seems to introduce a contrastive resonance specification in labials, where it is the place definitory property, in comparison with velars, where it specifies an acoustic property emerging from the configurational properties of the sound. The variation whereby only in a subset of varieties labials affect the distribution of [U], can be connected with the status of [U] in the spectral structure of the adjacent vowel, favouring the exclusion of the consonantal place interpretation of [U]. In other words, it is not the place to be involved but only the grave resonance properties.

The generalized weakening to [ə] of the unstressed vowels can be dealt with as the result of delinking; more precisely, in the approach of D'Introno and Weston (2002), delinking generates a featureless vowel, namely the totally underspecified vowel [ə], as in (41a). The blocking of the weakening of [u] in contexts of labial and velar consonants is accounted for by D'Introno and Weston (1997, 2002) as an effect of OCP.¹² The idea is that OCP requires harmonization by means of a repair strategy consisting of 'linking the two segments', in (41b). As a consequence delinking is prevented from applying in virtue of the Inalterability Convention on the linked structures (Hayes 1986). D'Introno and Weston (2002) note that the sequences where [u] is preserved could represent an OCP violation given that [labial] in labial contexts and [dorsal] in velar contexts would be shared by the vowel and the adjacent consonant. [u] is retained because of a linking process which operates as a repair strategy conflating the two identical adjacent features on an only tier, as in (41), where D = Dorsal and H = high.

¹² The recourse to OCP for dealing with harmonizing processes in C-V sequences is proposed in Mester (1988).

- (41) a.
$$\begin{array}{c} [u] \\ | \\ [D] \\ | \\ [Lab] \\ | \\ [H] \end{array} \rightarrow \begin{array}{c} [\text{ə}] \\ | \\ \emptyset \end{array} \quad \textit{delinking}$$
- b.
$$\begin{array}{ccc} k & u & k \quad u \\ | & | & \diagdown \quad / \\ [D] & [D] & [D] \\ | & | & | \\ [] & [Lab] & [Lab] \\ | & | & | \\ [H] & [H] & [H] \end{array} \rightarrow \begin{array}{c} [D] \\ | \\ [Lab] \\ | \\ [H] \end{array} \quad \textit{OCP repair strategy}$$
- (D’Introno and Weston 2002: 98)

D’Introno and Weston (2002: 99) note that this solution could explain why front vowels do not are preserved, given that they “do not share any feature with consonants”. Actually, this conclusion is not generally true, because front vowels share [+high] with palatals and velars, as noted also by D’Introno and Weston. Other questions arise. First, OCP does not apply in contexts including a stressed nucleus; this casts doubts on the effectiveness and adequacy of a principle apparently so restrictive. Moreover, the recourse to OCP does not seem fully necessary, insofar as delinking in weak position could mend the alleged incompatibility between a rounded back vowel and an adjacent velar/labial consonant, by reducing the vowel to [ə] without invoking OCP. We should expect that in a variety in which pre-tonic or stressed underlying /u/ realize as [ə] independently of the nature of the adjacent consonant, simply [ə] occurs in all contexts. In this sense, nothing would contradict OCP. On the contrary, [k] contexts retain [w], thus disputing the role of OCP. More in general, the recourse to OCP is questionable insofar as it adds no element useful for explaining the assimilation processes that seem more naturally and convincingly treated as types of phonological agreement in licensing domains.

As we saw, [u] preservation in Corato is not an isolated process. Rather, it can be connected with a more comprehensive class of phenomena, i.e. propagation discussed in Section 3 and preservation of [U] in Section 5. These phenomena retain/save or increase [u] realization in contexts of velar and possibly labial consonants. In other words, the occurrence of [u]/[w] is more naturally and adequately explained in terms of licensing mechanisms, i.e. assimilation/prominence. In all cases, the adjacency of a consonant including resonance properties compatible with [u] preserves or enhances the occurrence of [u], or, more precisely its melodic content [U]. The realization of [u]/[w] takes place despite the fact that a reduction process of unstressed

vowels is otherwise operating. The processes involving [u] preservation/propagation can be assigned the status of other harmony processes, whereby a property perceptually vulnerable, typically [round, back], and relevant for the purposes of recognizability gets extended, and consequently amplified, over a phonological domain (Kaun 1995, 2004; Walker 2005; Nevins 2010; Savoia 2015, 2016a; Manzini and Savoia 2016). In other words, harmonies increase the exposition of the hearer to morpho-phonological elements by preserving and enhancing its perceptibility (Kaun 1995; Walker 2005).

6.1 *A proposal*

The distribution in (40a,b) highlights the fact that licensing of [u]/[w] is interpreted by a preceding velar, so that in the sequence ...*u k*... [u] is saved only if it associates to the following [k], as in (40b''). In the case of (40b), where [u] is also preceded by [k], a double occurrence is triggered. In any case, it is the domain of the prominent nucleus that is involved and authorizes the realization of [u]/[w]. The relation between distribution of intensity in the string and reduction of pre-tonic vowels is confirmed by the data in (40d). Here, trochaic sequences preceding the main-stressed nucleus are able to retain the lexical vocalic content, at least in the case of rounded back vowels. Actually, preservation in these contexts is not obligatory, as indicated by the outcomes in (40d') and by the fact that front vowels however undergo reduction to [ə], as in (40e').

Coming now to the distribution of the vocalic outcomes in the strings, we note that all Southern Italian dialects we consider in this article, including varieties in (9), (15), (17), (18)-(19) and (35)-(36), are characterized by a prosodic organization whereby in unstressed position only simplex vowels are admitted, i.e. vowels including one element, as in (42):

- (42) In a non-prominent position only simplex (tendentially, non-headed) vowels are admitted

This requirement explains why in weak position only [a ə u] occur. For the sake of descriptive completeness, remember that, for example, in the dialects in (18) and (19) this same pattern of unstressed vowels emerges. An important difference concerns the distribution of the unstressed vowels, because in those dialects rounded back vowels are preserved as [u] independently of the adjacent consonant. So, we find realizations as, for example, [stu'tə:mə] 'we put out' for *Cirigliano*, where [u] occurs in a coronal context, differently from *Corato*, where [u] is limited to velar contexts. [a] escapes the weakening, keeping its content in unstressed contexts as well. This suggests that the headed [A] in pre-tonic position contributes to the prosodic organization of the sequence, excluding a real weakening.

If we consider the alternations of *Corato* dialect in the bases including a high rounded back vowel, like ['fujə] 'I.escape', in (40c), what we see is that pre-tonic weakening requires a non-headed element, as established in (42). In the case of [U] or [I] this content is generally interpreted as [ə] at sensorimotor interface, as in (43).

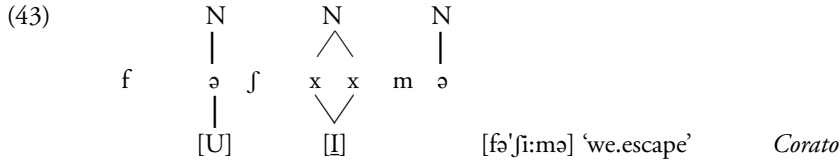

This analysis can explain why some phonetic traces of the lexical phonological distinctions can be perceived in unstressed outcomes. It is no accident that some uncertainty in detecting the weak pre-tonic realizations is well documented in the field researches, and it is noted by D'Introno and Weston (2002) as well. This solution agrees with the assumption that phonological content is interpretable at all levels and that substitution and addition of melodic content are forbidden. Besides, the underspecification approach adopted in D'Introno and Weston (1997, 2002) is excluded.

An interesting point is how this representation is distinct from one where [U] is consistently expressed. We note that the phonetic implementation of the elements can depend on both their phonological status (headed vs non-headed) and the context. In these varieties, losing the headed status in a weak/unstressed position is interpreted as a [ə]-like phonetic realization. In this sense, [ə] is nothing but a not completed or well-defined implementation of certain vowel inputs. This could impel us to extend the formantic element [F1] adopted in (10) to processes in which a vowel loses or reduces its place property, as suggested in (44). In other words, we could assign the acoustic configuration [F1] to the neuter vowel.

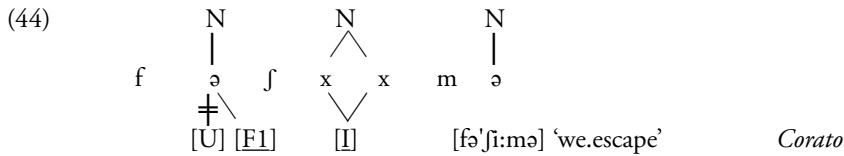

In [u] preserving contexts in (40), we will apply a treatment similar to that we have proposed for the process attested in *Ruvo* and *Accettura* dialects, in (35)-(36). In the pre-tonic contexts, the vowel [u] of the lexical base is retained where the sharing of [U] with [k] contributes to interpreting the content of the vowel in the domain of the stressed nucleus. Given that only velars in the domain of [u] (i.e. its onset) are involved in licensing, we must

conclude that the initial velar is necessary for interpreting [U], as indicated in (45a). As we underlined, the preservation allows [u] to have a longer temporal extension which enhances perceptual properties of [U]. This requirement is satisfied in all contexts where this is possible, i.e. when a velar is adjacent to [u]. If [k] follows the rounded back vocalic segment, [U] is realized as [w] in the following vocalic domain, i.e. inside the immediate domain of the stressed nucleus, as in (45b).

- (45) a.
- | | | | | |
|---|-----|-----|-----|------------------------------------|
| N | | N | | N |
| | | / \ | | |
| k | u | s | x | x |
| | / \ | | / \ | m |
| | [U] | | [U] | ə |
| | | | | [ku'si: mə] 'we.sew' <i>Corato</i> |
- b.
- | | | | | |
|---|---------|-----|-----|------------------------------------|
| N | | N | | N |
| | | / \ | | |
| ʃ | ə | k | x | a |
| | / \ | | / \ | m |
| | [F1][U] | | [A] | ə |
| | | | | [ʃə'kwamə] 'we.play' <i>Corato</i> |

(45b) illustrates the reduction of the pre-tonic vowel to [ə]. In the case of underlying mid vowels like [o o], the association of [U] to the stressed nucleus leaves the element [F1], phonetically [ə], as in (44).

Pre-tonic alternant [u] corresponding to stressed [o o], as in ['kəndzə]/[kun'dza:mə] 'I.season/we.season' in (40a), presents a partial reduction in the content of the vowel, as suggested in (42), where [u] is derived by delinking of [A]. The complete range of vowel properties is admitted only in the prominent vowel of the prosodic domain. (45) and (46) exemplify the contexts in which the [U] element is saved. In (45b) [U] is trapped in the following domain and only [A] is associated to the pre-tonic vowel, thus satisfying the requirement in (42). In (46) [U] is saved by being shared with initial [k]; (42) is satisfied by delinking of [A].

- (46)
- | | | | | |
|---|---------|-----|-----|--|
| N | | N | | N |
| | | / \ | | |
| k | x | n | dz | m |
| | / \ | | / \ | ə |
| | [U] [A] | | [A] | [kun'dza:mə] 'we.season' <i>Corato</i> |

Summarizing, pre-tonic [u] in the domain of the stressed nucleus is interpreted if it shares the resonance properties with an adjacent velar, so introducing a sufficient degree of perceptual strength. This mechanism is operating both in (45a)/(46) and (45b). The fact that in (45b) [U] is interpreted by means of the following consonant accounts for the reason why the preceding nucleus however realizes as [ə]; indeed [U] can be supported by a

preceding or following velar, and only in the first case it realizes the nucleus. In the second context, [U] occupies a slot internal to a different domain and the preceding nucleus undergoes the normal reduction process to [ə]. Only the particular context in (40b) in which [u] is both preceded and followed by a velar, makes a double licensing of [U] possible.

7. *Metaphony in Carmiano (Salento) and some conclusions*

In the Salento variety of *Carmiano* the occurrence of [w] in metaphonic diphthongs is limited to the contexts where it is preceded by a velar or a labial consonant.¹³ Vowel system of *Carmiano* includes three height degrees, high [i u], low-mid [ɛ ə], and low [a], vowels. Metaphony affects low-mid stressed vowels that in the presence of a high final vowel convert to a rising diphthong [jɛ wɛ], where the onglide retains the place property of the underlying/lexical low-mid vowel. The point is that the diphthong [wɛ] occurs only in contexts where it is preceded by a velar or a labial, as in (47a). In the other consonantal contexts, the reduced outcome [ɛ] appears, as in (47b); finally, [jɛ] remains unaltered in any context, as in (47c). Finally, in the word initial position some uncertainty emerges between [ɛ] and [wɛ] as in (47d,d'); [wɛ] is generally favoured if it is preceded by a vowel, for example the final [u] of the singular masculine object clitic or that of the singular masculine article. In unstressed pre-tonic position only high vowels, cf. (47e), or [a] occur, as stated in (42). We note that the data in (47) show that metaphony is partially morphologized since there is a subset of high vowels that do not trigger it, for instance the 1st sg *-u* in the present, as in [ˈfɔku] 'I.play'.

- (47) a. [ˈmɔu]/[ˈmwei]/[ˈmɔɛ] 'I.move/you.move/he.moves'
 [ˈpɔwɛku]/[ˈpɔwɛrtʃi] 'pig/pigs'
 [ˈkɔjju]/[ˈkɔwejji]/[ˈkɔjje] 'I.pick/you.pick/he.picks'
 [riˈkɔrdɔ]/[riˈkwɛrdi] 'I.remember/you.remember'
- b. [ˈtɔrmu]/[ˈtɛrmi]/[ˈtɔrmɛ] 'I.sleep/you.sleep/he.sleeps'
 [ˈfɔku]/[ˈfɛki]/[ˈfɔka] 'I.play/you.play/he.plays'
 [ˈsɔkra]/[ˈsɛkru] 'mother-in-law/father-in-law'
 [ˈnɔa]/[ˈneu] 'new.f/neu.m'
- c. [ˈpɛtɛ]/[ˈpjɛti] 'foot/feet'
 [pɛrdɔ]/[pjɛrdi] 'I.lose/you.lose'
 [kurˈtjɛdɔ]/[kurˈtjɛdɔ] 'knife/knives'
 [ˈsɛntu]/[ˈsjɛnti] 'I.feel/you.feel'
 [ˈljɛttu] 'bed'

¹³ A similar distribution of the metaphonic diphthong is described for Altamura in Loporcario (2001). According to this author, the deletion of *w* in initial position confirm the hypothesis that [w] is preserved by virtue of the labial or velar articulation place of the preceding consonant.

- d. [(l)'essu]/[lu 'wessu] 'the bone/the bone'
 ['eccu]/['eccu] 'eye/eyes'
 [(l)'eu] 'the eg'
- d'. [lu 'wei]/[tʃɛ b'bwɛi?] 'it you.want/what you.want?'
- e. ['pjɛrɔdi]/['pɛrɔɛ]/[pɪr'dimu] 'you.lose/he.loses/we.lose'
 [mɔɛ]/[mu'imu] 'he.moves/we.move'

As we have seen in Section 2, metaphony can be accounted for by assuming the licensing restriction in (10a) (here repeated in (48)), whereby aperture properties of the post-tonic vowel are realized on the stressed nucleus in order to be legitimized (Walker 2005; Savoia 2016a). Essentially, the occurrence of [i u] in final position (or post-tonic position, according to the dialect) requires the resonance element [I]/[U] in the stressed nucleus, in other words the alignment on the aperture degree. In Section 2, we have concluded that it is the low-frequency F1 that is duplicated on a lexical/underlying mid stressed nucleus.

- (48) The head vowel licenses [F1] in final/post-tonic position in the prosodic (foot) domain.

In *Carmiano*, the outcomes of metaphony are [jɛ] from [ɛ] and [wɛ] from [ɔ]; [I]/[U] elements are reproduced on the prominent nucleus of the domain. As regards [wɛ], it is maintained only if it is preceded both by a velar and a labial, hence as in the case of [u] propagation examined in Section 3. We can assume that [w], precisely [U], is licensed in the head only if the preceding adjacent labial or velar contributes to legitimizing it by sharing [U], as in (49). In other words, [w] manifests the metaphonic licensing but it is also involved in the licensing of the preceding consonant. The realization of [w] as a part of the stressed nucleus expresses the assimilatory process that is the core of licensing.

- (49)
- | | | |
|----------|-----|--|
| N | N | |
| / \ | | |
| m w ε | i | |
| / \ | / \ | |
| [U] [F1] | [I] | |
- [mwei] 'you.move' *Carmiano*

[U] does not occur in the contexts where it is not involved in licensing of the preceding consonant. In initial position of word [w] can be saved by a preceding [u], as in [lu 'wessu] 'the bone', in (43d). In these cases the preceding back vowel is able to anchor [U] of the following diphthong. Nevertheless, our data document a clear variability and uncertainty in the realizations preserving the initial [w] after a final -u, and show that the preferred realization excludes [w] in initial position. We could conclude that the forms without initial [w] are the basic representations.

As the phenomenon of *Carmiano* confirms, the interaction between back rounded vowels and velars and labials shows a significant micro-variation that makes slightly different restrictions to surface. Specifically, preservation of [w]/[u], i.e. the resonance property we characterize as [U], brings to light the harmonizing effect that underlies the relation between the head vowel of the domain and the consonant in its domain. The variation depends on factors such as the labial/velar difference, the position of the consonant in the string, the status of [a] in comparison with a stressed nucleus (in propagation), the possible interaction of more processes (propagation, preservation, metaphony). In all cases harmonizing effects extend the presence of [u]/[U] in the string enhancing its perceptibility (Kaun 1995; Walker 2005).

7.1 *Concluding remarks*

The minimalist approach in phonology we have adopted is inspired by the idea that phonology and morphology are processes that make lexical and syntactic objects accessible to the sensorimotor system, in the sense of Berwick and Chomsky (2011: 27):

Language is therefore based on a recursive generative procedure that takes elementary word-like elements from some store, call it the lexicon, and applies repeatedly to yield structured expressions, without bound. Externalization is not a simple task [...] We would expect, then, that morphology and phonology - the linguistic processes that convert internal syntactic objects to the entities accessible to the sensorimotor system - might turn out to be quite intricate, varied, and subject to accidental historical events.

An adequate theory must be able to express variation, normally observable in languages, including the varieties we have analysed here. According to perspective proposed by Berwick and Chomsky (2011), linguistic variation and differentiation can be understood as a by-product of the externalization process. More precisely, it is a result of the fact that morpho-phonological processes come into contact with sensorimotor and conceptual-intentional systems that can influence and modify the phonetic and semantic properties of lexical elements (Savoia and Baldi 2009; Manzini and Savoia 2011).

The main issue we have addressed in this article is the way of representing the relations between segments in the string. In the GP framework (Kaye 1990; Charette 1991; Harris 1994; Kaye, Lowenstamm, Vergnaud 1990) the acoustic potential of a segment depends on the structural relations between autosegmental slots in the structure. A recent revision proposed in this model aims to translate (a part of) melodic properties into structural properties, so reducing the redundancies observed between the structural organization and the segmental content (Pöchtrager 2006, 2010; Pöchtrager and Kaye 2013; Kaye 2014). Moreover, this revision reduces the prosodic categories to onsets (con-

sonants) and nuclei (vowels), abandoning the traditional asymmetry between onset and coda inside the syllable.

We have tried to assign to the acoustic potential of a segment a basic role in establishing the structural organization of the string. We aim to overcome the interpretive difficulties deriving from a rigid structural categorization introduced in GP and more in general in metrical approaches. In this perspective, the organization of the string is implemented in terms of assimilation processes and prosodic strength asymmetries (duration, intensity, melodic height). Licensing is translated into its primitive components, i.e. assimilation in melodic properties or partial melodic depletion/attraction of the weak position by the strong position. We discuss these points in relation to some assimilatory processes in which vowels and consonants affect one another independently of the canonical governing relation assumed in GP and in general in the syllabic theories. Specifically, in the propagation processes we investigate in the article, the relation between [u] and velar (and labial) consonants is determined by their adjacency, left-to-right and right-to-left. An interesting micro-variation emerges involving a set of elementary properties, such as the different role of [U] in velar and labial consonants, the prosodic organization of the relevant domains, the quality and status of the vowels hosting propagation, the interaction with metaphony.

References

- Anderson, Stephen R. 1974. *The Organization of Phonology*. New York: Academic Press.
- Backley, Phillip. 2011. *An Introduction to Element Theory*, Edinburgh: Edinburgh UP.
- Bafile, Laura. 1994. "La riassegnazione postlessicale dell'accento nel napoletano." *Quaderni del Dipartimento di Linguistica dell'Università di Firenze* 5, 1-23.
- Bafile, Laura. 1996. "Sulla rappresentazione delle strutture metriche ternarie." *Quaderni del Dipartimento di Linguistica dell'Università di Firenze* 7: 45-67.
- Bafile, Laura. 1999. "Antepenultimate stress in Italian and some related dialects: metrical and prosodic aspects." *Rivista di linguistica* 11 (2): 201-229.
- Berwick, Robert, and Noam Chomsky. 2011. "The Biolinguistic Program: The Current State of its Evolution and Development." In *The Biolinguistic Enterprise*, ed. by Anna Maria Di Sciullo and Cedric Boeckx, 19-41. Oxford: Oxford UP.
- Booij, Geert. 1989. "On the Representation of Diphthongs in Frisian." *Journal of Linguistics* 25 (1): 319-332.
- Bucci, Jonathan. 2013. *Raddoppiamento Fonosintattico indotto per l'accento et réduction vocalique en Italie: perspectives phonologique et dialectologique*. PhD Dissertation, Université Nice Sophia Antipolis.
- Calabrese, Andrea. 1998. "Metaphony revisited." *Rivista di linguistica* 10: 7-68.
- Carosella, Maria. 1998/1999. "La metaforesi nei dialetti garganici nord-occidentali." *Quaderni del Dipartimento di Linguistica dell'Università di Firenze* 9: 97-138.
- Carosella, Maria. 2005. *Sistemi vocalici tonici nell'area garganica settentrionale fra tensioni diatopiche e dinamiche variazionali*. Roma: Edizioni Nuova Cultura.
- Charette, Monik. 1991. *Conditions on Phonological Government*. Cambridge: Cambridge UP.

- Chomsky, Noam. 1995. *The Minimalist Program*. Cambridge: The MIT Press.
- Chomsky, Noam. 2005. "Three Factors in Language Design." *Linguistic Inquiry* 36 (1): 1-22.
- Chomsky, Noam. 2013. "Problems of Projection." *Lingua* 130: 33-49.
- Clements, George N. 1993. "Lieu d'articulation des consonnes et des voyelles: une théorie unifiée." In *Architecture des représentations Phonologiques*, ed. by Bernard Laks and Annie Rialland, 101-145. Paris: CNRS Éditions.
- Clements, George N., and Elizabeth Hume. 1995. "The Internal Organization of Speech Sounds." In *The Handbook of Phonological Theory*, ed. by John A. Goldsmith, 245-306. Oxford: Blackwell.
- Demirdache, Hamida. 1988. "Transparent Vowels." In *Features, Segmental Structure and Harmony Processes (Part II)*, ed. by Harry van der Hulst and Norval Smith, 39-76. Dordrecht: Foris.
- D'Introno, Francesco, and Rosemary Weston. 1997. "Preservazione, cambio e riduzione vocalica in Coratino: effetti e strategie dell'OCP." In *Atti del Terzo Convegno della Società Internazionale di Linguistica e Filologia Italiana*, a cura di Luciano Agostiniani et al., 287-302. Napoli: Edizioni Scientifiche Italiane.
- D'Introno, Francesco, and Rosemary Weston. 2002. "Vowel Alternation, Vowel/Consonant Assimilation and OCP Effects in a Barese Dialect." In *Phonological Theory and the Dialects of Italy*, ed. by Lori Repetti, 89-110. Amsterdam: Benjamins.
- Féry, Caroline. 2001. "Markedness, Faithfulness, Vowel Quality and Syllable in French." *LiP 16 Phonology in Potsdam*: 1-31.
- Goldsmith, John A. 1990. *Autosegmental and Metrical Phonology*. Oxford: Blackwell.
- Harris, James W. 1985. "Spanish Diphthongisation and Stress: A Paradox Resolved." *Phonology Yearbook* 2: 31-45.
- Harris, John. 1990. "Segmental Complexity and Phonological Government." *Phonology* 7: 255-300.
- Harris, John. 1994. *English Sound Structure*. Oxford: Blackwell.
- Harris, John, and Geoff Lindsey. 1990. "Phonetic Interpretation in Generative Grammar." *UCL Working Papers in Linguistics* 2: 355-369.
- Harris, John, and Geoff Lindsey. 1995. "The Elements of Phonological Representation." In *Frontiers of Phonology*, ed. by Jacques Durand and Francis Katamba, 34-79. London: Longman.
- Hayes, Bruce. 1986. "Inalterability in CV Phonology." *Language* 62: 321-351.
- Jakobson, Roman. 1968. *Child Language, Aphasia and Phonological Universals*. The Hague: Mouton.
- Jakobson, Roman. 1971. *Phonological Studies*. Paris, The Hague: Mouton.
- Jakobson, Roman, Gunnar M. Fant, and Morris Halle. 1952. *Preliminaries to Speech Analysis*. Cambridge: The MIT Press.
- Jensen, Sean. 1994. "Is P an Element? Towards a Non-segmental Phonology." *SOAS Working Papers in Linguistics & Phonetics* 4: 71-78.
- Kaun, Abigail. 1995. *The Typology of Rounding Harmony. An Optimality Theoretic Approach*. PhD Dissertation, UCLA.
- Kaun, Abigail. 2004. "The Typology of Rounding Harmony." In *Phonetically Based Phonology*, ed. by Bruce Hayes, Robert Kirchner and Donca Steriade, 87-116. Cambridge: Cambridge UP.

- Kaye, Jonathan. 1986/1987. "Government in Phonology. The Case of Moroccan Arabic." *The Linguistic Review* 6: 131-159.
- Kaye, Jonathan. 1990. "Coda licensing." *Phonology* 7: 301-330.
- Kaye, Jonathan. 2014. "The Ins and Outs of phonology." In *The Form of Structure, the Structure of Form*, ed. by Sabrina Benjaballah, Noam Faust, Mohamed Lahrouchi and Nicola Lampitelli, 255-269. Amsterdam-Philadelphia: John Benjamins.
- Kaye, Jonathan, Jean Lowenstamm, and Jean-Roger Vergnaud. 1985. "The Internal Structure of Phonological Elements: A Theory of Charm and Government." *Phonology Yearbook* 2: 305-328.
- Kaye, Jonathan, Jean Lowenstamm, and Jean-Roger Vergnaud. 1990. "Constituent structure and government in phonology." *Phonology* 7: 293-231.
- Kenstowicz, Michael, and Charles Kisseberth. 1979. *Generative Phonology*. New York: Academic Press.
- Kiparsky, Paul. 1985. "Some Consequences of Lexical Phonology." *Phonology Yearbook* 2: 85-138.
- Leben, William. 1973. *Suprasegmental Phonology*, PhD Dissertation, MIT.
- Leben, William. 1978. "The Representation of Tone." In *Tone: A Linguistic Survey*, ed. by Victoria Fromkin, 177-219. New York: Academic Press.
- Lombardo, Giuseppe. 1901. *Saggi sul dialetto nisseno*. Caltanissetta.
- Loporcaro, Michele. 2001. "Distinctive Features and Phonological Change: Vowel Fronting and Gravity Interactions in Altamurano." *Rivista di Linguistica/Italian Journal of Linguistics* 13: 255-308.
- Lowenstamm, Jean. 1996. "CV as the Only Syllable Type." In *Current Trends in Phonology Models and Methods*, ed. by Jacques Durand, 419-442. European Studies Research Institute, University of Salford.
- Maiden, Martin. 1985. "'Displaced' metaphony and the morphologisation of metaphony." *Romance Philology* XXXIX (1): 22-34.
- Maiden, Martin. 1987. "New Perspectives on the Genesis of Italian Metaphony." *Transactions of Philological Society* 85 (1): 38-73.
- Manzini, M. Rita, and Leonardo M. Savoia. 2011. "(Bio)linguistic Variation: have/be Alternations in the Present Perfect." In *The Bilingualistic Enterprise*, ed. by Anna Maria Di Sciullo and Cedric Boeckx, 222-265. Oxford: Oxford UP.
- Manzini, M. Rita, and Leonardo M. Savoia. 2016. "Which Syntactic Information gets Interpreted by Phonosyntactic Processes? Evidence from /u/ propagation in Southern Italian Dialects". In *Approaches to Metaphony in the Languages of Italy*, ed. by Francesc Torres-Tamarit, Kathrin Linke and Marc van Oostendorp, 221-258. Berlin: De Gruyter.
- Manzini, M. Rita, and Leonardo M. Savoia. Submitted. "Enclisis/Proclisis Alternations in Romance: allomorphies and (re)ordering."
- Marotta, Giovanna. 1988. "The Italian Diphthongs and the Autosegmental Framework." In *Certamen phonologicum, Papers from the 1987 Cortona Phonology Meeting*, ed. by Pier Marco Bertinetto and Michele Loporcaro, 389-420. Torino: Rosenberg & Sellier.
- Mester, Armin. 1988. "Dependent tier ordering and the OCP." In *Features, Segmental Structure and Harmony Processes (Part II)*, ed. by Harry van der Hulst and Norval Smith, 127-144. Dordrecht: Foris Publications.

- Mocciaro, A. Giuseppina. 1978. "Postille siciliane alla Grammatica storica della lingua italiana e dei suoi dialetti di G. Rohlfs." *Quaderni di filologia e letteratura siciliana* 5: 89-113.
- Odden, David. 1986. "On the Role of the Obligatory Contour Principle in Phonological Theory." *Language* 62 (2): 353-383.
- Odden, David. 1995. "Tone: African Languages." In *The Handbook of Phonological Theory*, ed. by John A. Goldsmith, 444-475. Oxford: Blackwell.
- van Oostendorp, Marc. 2013. "σ strikes back: A defense of headedness and constituency in phonology." *The Linguistic Review* 30 (2): 347- 371.
- Ordóñez, Francisco, and Lori Repetti. 2005. "Stressed Enclitics." In *New Perspectives on Romance Linguistics*, ed. by Jean-Pierre Montreuil, 167-183. Amsterdam-Philadelphia: John Benjamins.
- Peperkamp, Sharon. 1996. "On the Prosodic Representation of Clitics." In *Interfaces in phonology*, *Studia grammatica* 41, ed. by Ursula Kleinhenz, 102-127. Berlin: Akademie Verlag.
- Piccillo, Giuseppe. 1971. "La 'propagginazione' dans les dialectes siciliens." *Revue roumaine de linguistique* 16 (2): 135-143.
- Pöchtrager, Markus. 2006. *The Structure of Length*, Ph.D. Dissertation, University of Vienna.
- Pöchtrager, Markus. 2015. "Binding in Phonology." In *Representing Structure in Phonology and Syntax*, ed. by Marc van Oostendorp and Henk van Riemsdijk, 255-275. Amsterdam-Philadelphia: John Benjamins.
- Pöchtrager, Markus, and Jonathan Kaye. 2013. "GP2.0." *SOAS Working Papers in Linguistics* 16: 51-64.
- Rizzi, Luigi, and Leonardo M. Savoia. 1993. "Conditions on /u/ Propagation in Southern Italian Dialects: a Locality Parameter for Phonosyntactic Processes." In *Syntactic Theory and the Dialects of Italy*, ed. by Adriana Belletti, 252-318. Torino: Rosenberg & Sellier.
- Rohlfs, Gerhard. 1966 [1949]. *Grammatica storica della lingua italiana e dei suoi dialetti. Fonetica [Historische Grammatik der Italienischen Sprache und ihrer Mundarten. I - Lautlehre]*. Torino: Einaudi.
- Savoia, Leonardo M. 1987. "Teoria generativa, modelli fonologici e dialettologia. La propagazione di u in una varietà lucana." *Rivista Italiana di Dialettologia* XI: 185-263.
- Savoia, Leonardo M. 1990. "Proprietà vocaliche e struttura metrico-sillabica in alcune varietà abruzzesi." In *Studi in memoria di Ernesto Giammarco*, 331-380. Pisa: Giardini.
- Savoia, Leonardo M. 2015. *I dialetti italiani. Sistemi e processi fonologici nelle varietà di area italiana e romancia*. Pisa: Pacini.
- Savoia, Leonardo M. 2016a. "Harmonic processes and metaphony in some Italian varieties." In *Approaches to Metaphony in the Languages of Italy*, ed. by Francesc Torres-Tamarit, Kathrin Linke and Marc van Oostendorp, 9-53. Berlin & Boston: De Gruyter.
- Savoia, Leonardo M. in press b. "Enhancing Stressed /a/ Low Frequency Components in the Context of Sonorants. Some Proposals on the Phonological Representations." *Linguistics Beyond and Within* 2.

- Savoia, Leonardo M., and Benedetta Baldi. 2009. *Lingua e società. La lingua e i parlanti*. Pisa: Pacini.
- Savoia, Leonardo M., and Elisabetta Carpitelli. 2008. "Problèmes de micro-variation phonologique dans les domaines dialectaux de l'Italie septentrionale." *Revue française de linguistique appliquée* 13 (2): 103-119.
- Savoia, Leonardo M., and Martin Maiden. 1997. "Metaphony." In *The Dialects of Italy*, ed. by Martin Maiden and Mair Parry, 15-25. London: Routledge.
- Schirru, Giancarlo. 2008. "Propagginazione e categorie nominali in un dialetto del Molise." In *I dialetti meridionali tra arcaismo e interferenza, Atti del Convegno Internazionale di Dialettologia (Messina, 4-6 giugno 2008)*, ed. by Alessandro De Angelis, 291-309. Palermo: Centro di Studi Filologici e Linguistici Siciliani.
- Schirru, Giancarlo. 2013. "La propagginazione in un dialetto della Valle di Comino." In *Lingua e dialetto tra l'Italia centrale e l'Italia meridionale. I dialetti della Media Valle del Liri e delle zone limitrofe*, a cura di Francesco Avolio, 78-91. Roccasecca: Arte Stampa Editore.
- Schirru, Giancarlo. 2014. *Propagginazione e morfologia nominale in alcuni dialetti centro-meridionali*, paper presented at *Cambridge Italian Dialect Syntax-Morphology Meeting* (CIDSMS 8), Padova-Venezia, June 20-22.
- Stehl, Thomas. 1980. *Die Mundarten Apuliens historische und strukturelle Beiträge*. Münster: Aschendorf.
- Stehl, Tomas. 1988. "Puglia e Salento." In *Lexikon der Romanistischen Linguistik, IV*, ed. by Günter Holtus, Michael Metzeltin and Christian Schmitt, 695-716. Tübingen: Niemeyer.
- Trumper, John. 1987. "Il vocalismo del dialetto di Matera: primi risultati." *Quaderni del Dipartimento di Linguistica, Serie Linguistica* 2: 37-60. Università della Calabria.
- Tuttle, Edward F. 1985. "Assimilazione 'permansiva' negli esiti centro-meridionali di A tonica." *L'Italia Dialettale* 48: 1-34.
- Walker, Rachel. 2005. "Weak triggers in vowel harmony." *Natural language and linguistic theory* 23: 917-989.