

LM IB pottery

relative chronology and
regional differences

Acts of a workshop held
at the Danish Institute at
Athens in collaboration
with the INSTAP
Study Center
for East Crete,
27-29 June 2007

Edited by
Thomas M. Brogan
& *Erik Hallager*



Monographs of the Danish Institute at Athens, Volume 11, 2

LM IB pottery

relative chronology and regional differences

Acts of a workshop held at the Danish Institute at Athens in
collaboration with the INSTAP Study Center for East Crete,
27–29 June 2007

Edited by

Thomas M. Brogan & Erik Hallager



Monographs of the Danish Institute at Athens
Volume 11, 1

© Copyright The Danish Institute at Athens, Athens 2011

LM IB pottery – relative chronology and regional differences

Monographs of the Danish Institute at Athens

Volume 11, 1

General Editor: Rune Fredriksen and Erik Hallager

Graphic design: Erik Hallager

Printed at Narayana Press

Printed in Denmark on permanent paper
conforming to ANSI Z 39.48–1992

The publication was sponsored by:

The Carlsberg Foundation

The Institute for Aegean Prehistory

ISBN: 978 87 7934 573 7

Distributed by:

AARHUS UNIVERSITY PRESS

Langelandsgade 177

DK–8200 Århus N

www.unipress.dk

Gazelle Book Services Ltd.

White Cross Mills, Hightown

Lancaster LA1 4XS, England

www.gazellebooks.com

The David Brown Book Company (DBBC)

P.O. Box 511

Oakville, CT. 06779, USA

www.davidbrownbookco.uk

Cover illustration:

Double vase from the Royal Road: North at Knossos

Contents

Volume 1

- 8 List of contributors
- 11 Preface
Erik Hallager & Thomas M. Brogan
- 13 Bibliography
- 39 Introduction
Thomas M. Brogan
- 55 LM IB pottery in Khania
Maria Andreadaki-Vlazaki
- 75 From LM IB Marine Style to LM II marine motifs. Stratigraphy, chronology and the social context of a ceramic transformation: a response to Maria Andreadaki-Vlazaki
Eleni Hatzaki
- 93 The LM I pottery from the ceramic workshop at Zominthos
Sebastian Traunmueller
- 109 Response to Sebastian Traunmueller
Nicola Cucuzza
- 117 LM IB pottery from the colonies. Hagios Georgios sto Vouno, Kythera
Iphigenia Tournavitou
- 141 Kythera, the Levant, Myrtos-Pyrgos and Knossos: a response to Iphigenia Tournavitou
Gerald Cadogan
- 153 Knossos Royal Road: North, LM IB deposits
Sinclair Hood
- 175 Response to Sinclair Hood
Birgitta P. Hallager
- 183 Late Minoan IB pottery from Knossos: Stratigraphical Museum Excavations, the North Building
Peter M. Warren
- 197 The final LM IB destructions at Knossos and at Phaistos: a response to Peter Warren
Orazio Palio
- 205 LM I pottery groups from the Palace and the town of Galatas, Pediada
Giorgos Rethemiotakis & Kostis S. Christakis

- 229 Response to Giorgos Rethemiotakis & Kostis Christakis
Tim Cunningham
- 241 Pithoi and economy in LM IB state societies
Kostis S. Christakis
- 255 Remarks on storage and chronology in Late Cycladic I Akrotiri, Thera: a response to Kostis Christakis
Irene Nikolakopoulou
- 267 From the end of LM IA to the end of LM IB: the pottery evidence from Hagia Triada
Dario Puglisi
- 291 Makrygialos reloaded: the LM IB pottery: a response to Dario Puglisi
Eleni Mantzourani
- 307 Late Minoan IB at Kommos: a sequence of at least three distinct stages
Jeremy B. Rutter

Volume 2

- 345 LM IB pottery from the rural Villa of Pitsidia: a response to Jeremy Rutter
Despina Chatzi-Vallianou
- 379 Pottery from the LM IB building at Skinias
Stella Mandalaki
- 393 Time, place and practice in the East Mesara: the case of Skinias. A response to Stella Mandalaki
Carl Knappett
- 401 Pottery at Pseira in LM IB
Philip P. Betancourt
- 413 Response to Philip P. Betancourt
Penelope Mountjoy
- 427 Pottery of the late Neopalatial periods at Mochlos
Kellee A. Barnard & Thomas M. Brogan
- 451 LM IB phases at Mochlos and the single phase of LM IB at Knossos: a response to Kellee Barnard & Thomas Brogan
Colin F. Macdonald
- 463 LM IB Petras: the pottery from Room E in House II.1
Metaxia Tsipopoulou & Maria Emanuela Alberti
- 499 An introduction to the LM IB pottery from Poros: a response to Metaxia Tsipopoulou and Emanuela Alberti
Eleni S. Banou

- 513 The LM IB Renaissance at postdiluvian Pre-Mycenaean Palaikastro
Seán Hemingway, J. Alexander MacGillivray & L. Hugh Sackett
- 531 LM IB ceramic phases at Palaikastro and Malia: a response to Seán Hemingway, J. Alexander MacGillivray & L. Hugh Sackett
Aleydis Van de Moortel
- 553 Between Palaikastro and Zakros: the pottery from the final Neopalatial horizon of the Sea Guard-House, Karoumes
Leonidas Vokotopoulos
- 573 The LM IB pottery from Papadiokampos: a response to Leonidas Vokotopoulos
Thomas M. Brogan, Chrysa Sofianou & Jerolyn E. Morrison
- 595 Zakros: one or two destructions around the end of the LM IB period
Lefteris Platon
- 613 A West Cretan response (Nerokourou) to Lefteris Platon and the LM IB pottery from Zakros
Athanasia Kanta
- 627 Closing comments
Wolf-Dietrich Niemeier
- 629 General Discussion
- 647 Shape illustration index
Thomas M. Brogan
- 650 Index

List of contributors

Maria Emanuela Alberti
University of Udine, Italy
correspondence to:
Via Anapo 29
I-00199 Roma
Italy
memalberti@gmail.com

Maria Andreadaki-Vlazaki
General Director of Antiquities
Hellenic Ministry of Culture and
Tourism
Bouboulinas 20–22
GR-106 82 Athens
Greece
mvlazaki@otenet.gr

Eleni Banou
Director of the Department of
Sites at the
Second Ephorate of Prehistoric
and Classical Antiquities
Sygrou Ave. 98–100
GR-11741 Athens
Greece
ebanou@freemail.gr

Kellee A. Barnard
Classics Department
McCormack 4/649
University of Massachusetts
Boston, MA 02125
USA
kelleebarnard@yahoo.com

Philip P. Betancourt
Department of Art History
Tyler School of Art Building
Temple University
Philadelphia, PA 19122
USA
ppbcourt1@aol.com

Thomas M. Brogan
INSTAP Study Center for East
Crete
Pacheia Ammos
GR-72200 Ierapetra
Greece
instapec@otenet.gr

Gerald Cadogan
The Old Rectory
Culworth
Banbury OX17 2AT
England
geraldcadogan@onetel.com

Despina Chatzi-Vallianou
Museum of Cretan Ethnology
Researche Centre – Vori –
GR-70200 Tympaki, Crete
Greece
info@cretanethnologymuseum.gr

Kostis S. Christakis
University of Crete
Department of Education
Rethimnon, Crete
Greece
christakis@her.forthnet.gr

Nicola Cucuzza
Università di Genova
Dipartimento di Archeologia e
Filologia Classica
via Balbi, 4
I-16126 Genova
Italy
nicola.cucuzza@lettere.unige.it

Tim Cunningham
Département d'Archéologie
Université Catholique de Louvain
Place B. Pascal 1
B-1348 Louvain-la-Neuve
Belgium
Tifocu@aol.com

Birgitta P. Hallager
Greek-Swedish Excavations
c/o Danish Institute at Athens
Herefondos 14
GR-10558 Athens
Greece
klabph@hum.au.dk

Erik Hallager
Danish Institute at Athens
Herefondos 14
GR-10558 Athens
Greece
klaeh@hum.au.dk

Eleni Hatzaki
Asst. Professor of Mediterranean
Archaeology
Department of Classics
University of Cincinnati
P.O. Box 210226
Cincinnati OH 45221–0226
USA
eleni.hatzaki@uc.edu

Seán Hemingway
Associate Curator
Department of Greek and Roman
Art
The Metropolitan Museum of Art
1000 Fifth Avenue
New York, New York 10028–0198
USA
Sean.Hemingway@metmuseum.org

Sinclair Hood
The Old Vicarage,
Great Milton, Oxford,
OX44 7PB,
U.K.

Athanasia Kanta
23rd Ephorate of Prehistoric and
Classical Antiquities
Xanthoudidou & Hadjidaki 1
GR-712 02 Heraklion
Greece
athanasiaka@gmail.com

Carl Knappett
Walter Graham/Homer Thompson
Chair in Aegean Prehistory,
Department of Art,
University of Toronto,
Canada
carl.knappett@utoronto.ca

Colin Macdonald
British School at Athens
Souidias 52
GR-10676 Athens
Greece
cfmgr@her.forthnet.gr

J. Alexander MacGillivray
Co-director Palaikastro Excavations
of the British School at Athens
Ampelonon 50
GR-19002 Paiania
Greece
macgillivrayalexander@yahoo.com

Stella Mandalaki
23rd Ephorate of Prehistoric and
Classical Antiquities
Xanthoudidou & Hadjidaki 1
GR-712 02 Heraklion
Greece
stmandalaki@gmail.com

Eleni Mantzourani
Professor of Prehistoric
Archaeology
Dept. of History and Archaeology
School of Philosophy
University of Athens
University Campus, Zographou
GR-15784 Athens
Greece
emantzou@arch.uoa.gr

Penelope Mountjoy
British School at Athens
Souidias 52
GR-10676 Athens
Greece

Irene Nikolakopoulou
Archaeological Institute of Aegean
Studies
Plateia Megalou Alexandrou
GR-85100 Rhodes
Greece
irene_nikolak@hotmail.com

Wolf-Dietrich Niemeier
Deutsches Archäologisches Institut
Athen
Fidiou 1
GR-10678 Athens
Greece
niemeier@athen.dainst.org

Orazio Palio
Dipartimento Processi Formativi
Università di Catania
Via Biblioteca 4
I-95124 Catania
Italy
horpa@tiscali.it

Lefteris Platon
Department of History and
Archaeology
University of Athens
School of Philosophy
University Campus, Zographou
GR-15784 Athens
Greece
eplaton@arch.uoa.gr

Dario Puglisi
Università di Catania
Dipartimento SAFIST
via Biblioteca 4 (Palazzo Ingrassia)
I-95124, Catania
Italy
dariopuglisi@yahoo.it

Giorgos Rethemiotakis
Director
The Archaeological Museum
Xanthoudidou 1
GR-712 02 Heraklion
Greece
amh@culture.gr

Jeremy B. Rutter
Department of Classics
Dartmouth College
Hanover, New Hampshire 03755-
3506
U.S.A.
Jeremy.B.Rutter@Dartmouth.EDU

L. Hugh Sackett
Co-director Palaikastro Excavations
British School at Athens,
52 Souidias
GR-106 76 Athens
Greece
hsackett@groton.org

Iphigenia Tournavitou
Associate Professor
Department of History,
Archaeology and Social
Anthropology
University of Thessaly
Argonafton & Filellinon St.
GR-382 21 Volos
Greece
tournavou@ath.forthnet.gr
iftourna@uth.gr

Sebastian Traunmueller
Institut für Klassische Archäologie
Ruprecht-Karls-Universität
Heidelberg
Marstallhof 4
DE-69117 Heidelberg
Germany
sebastian.traunmueller@
googlemail.com

Metaxia Tsipopoulou
Hellenic Ministry of Culture and
Tourism
Director
Directorate of the National
Archive of Monuments
11, Agion Asomaton Street
GR-105 53 Athens
Greece
mtsipopoulou@culture.gr

Aleydis Van de Moortel
Department of Classics
University of Tennessee
Knoxville, TN 37996
U.S.A.
avdm@utk.edu

Leonidas Vokotopoulos
Aghias Varvaras 32
GR-152 31 Chalandri, Athens
Greece
leonvok@gmail.com

Peter M. Warren
Professor Emeritus
Dept of Archaeology and
Anthropology,
University of Bristol,
43 Woodland Road,
BRISTOL BS8 1UU
UK
p.m.warren@bristol.ac.uk



The participants of the workshop gathered in the Hagia Aikaterini Square outside the Danish Institute.

Preface

Once upon a time – in early 2005 – when the Minoan Seminar was still under the auspices of the Danish Institute at Athens, Tom Brogan mentioned that it might be a good idea to have a workshop on LM IB pottery focusing on the disagreement and unsolved problems connected with recent excavations in East Crete. We talked about it a couple of times without doing much, but then during the summer of 2006 we started to ask around and found that the time was ripe for such a workshop. We were particularly fortunate because the timing of the 10th Cretological Congress in Khania allowed us to discuss the matter with our colleagues who were not resident in Greece. After many positive reactions we started to plan. Because it had to be a low-budget workshop, we chose late June 2007 when most excavators with knowledge of LM IB pottery would be in Greece and accommodations in Athens would not be so difficult to arrange.

With the experience from the LM III pottery workshop held at the Danish Institute in 1994, we decided to invite excavators with unpublished, stratified LM IB deposits as speakers. Each speaker would also have a respondent who was an excavator with unpublished LM IB material so that they could use the experience and knowledge from their own excavations in preparing their responses. In the few cases where we could not find excavators with LM IB material as respondents, we invited scholars who were experienced in the topic. As with the LM III pottery workshop, there were no strict time limits for any of the presentations. Not everyone was able to attend the workshop, and we are grateful that Leonidas Vokotopoulos offered his paper on Karoumes for the publication and that T.M. Brogan, Ch. Sofianou, and J.E. Morrison could provide a response to his paper. We also thank Eleni

Banou for her reply to the Petras paper, which was read at the workshop in her absence.

For three days, from the 27th to the 29th of June 2007, 30 scholars presented their material and responded to questions from a wider audience in an informal and relaxed atmosphere, and there was plenty of discussion after each of the presentations. We want to thank the staff of the Danish Institute, who kindly facilitated our workshop during a very warm spell in Athens, and Yuki Furuya, who helped manage logistical problems and recorded the discussions. We also owe a warm round of thanks to Alexander MacGillivray for transcribing the discussions.

Concerning the publication of the workshop, the editing of the figures and illustrations was left to Erik Hallager, while Tom Brogan undertook the review and editing of the contributions – except his own. In this technical editorial work, he was greatly assisted by Dr. Melissa Eaby whose skill and competence in copy editing has greatly improved the outcome of the publication. We also want to thank Birgitta Hallager for assisting in the editorial work. Because the text editor of the book is American we have, perhaps to the distress of some British authors (and the general editor of the series of the Danish Institute), used American English for the book.

Throughout the book all drawings of pottery are – unless otherwise stated – given at a scale of 1:3. Greek place names are with very few exceptions spelled according to the suggestions given by the INSTAP Academic Press. All measurements are given as provided by the authors, while a few abbreviations have been standardized throughout the book:

d. for diameter; h. for height; th. for thickness; pres. for preserved; and dep. for deposit.

One issue that the workshop did not try to address was terminology. In Denmark there is a proverb “a beloved child has many names” and during the workshop we realized that LM IB pottery labels are like beloved children to the participants. To remedy any confusion this may cause, we have created a shape index, and in the ordinary index given page references in italics when a shape is illustrated.

Both Tom and Erik want to thank all the contributors for their excellent collaboration in all matters and for their patience with our requests concerning both texts and illustrations. In addition, Birgitta and Erik Hallager want to thank Rachel and Sinclair Hood for their warm hospitality at Great Milton, while assisting Sinclair Hood with

the selection and scanning of images for his Royal Road paper.

We want to thank all who contributed financially to the workshop and the publication, particularly our institutions, the Danish Institute at Athens and the INSTAP Study Center for East Crete. As always we want to acknowledge our gratitude to the Institute for Aegean Prehistory for their constant support. Last but not least, our sincere thanks are also due to the Carlsberg Foundation and the Institute for Aegean Prehistory for covering the costs of the publication.

Crete, May 2011
Erik Hallager & Thomas M. Brogan

LM IB Petras: the pottery from Room E in House II.1*

Metaxia Tsipopoulou & Maria Emanuela Alberti

I. Introduction (M. Tsipopoulou)

For the past 23 years, archaeological investigations at Petras (Fig. 1) have shown that the primary phase of occupation was the Protopalatial period, and not the Neopalatial phase as the excavator originally believed.¹ The earliest occupation in the area dates to the Final Neolithic and Early Minoan I and is located on Kephala Hill. Finds were initially discovered on this hill during an intensive surface survey in 1986² and more recently, during rescue excavations on the hilltop.³ From Early Minoan II onwards, the settlement at Petras witnessed a sig-

nificant change. The inhabitants moved the settlement to the neighboring rise, Hill I, which we call Petras proper, and established a cemetery of house tombs and rock shelters on Kephala Hill near the earlier settlement.

This new occupation on Hill I continued uninterrupted until the end of the LM IB period. In MM IIA a Palace was constructed on Hill I, and it was destroyed in MM IIB. The Palace was likely repaired immediately, though excavation failed to produce stratified, early Neopalatial deposits. The building was again destroyed in LM IA, and following major changes to the plan, reoccupied at a reduced scale in LM IB.

The most important LM IB changes involved the transformation of the Central Court, the abandonment of the monumental staircase, and other general modifications to circulation patterns.⁴ It appears that the final Neopalatial phase at Petras was a period of stress and uncertainty, as suggested by the increase in storage space. Some areas of the Palace, originally equipped with flagstone floors, were now refashioned with floors of beaten earth and used for storing pithoi (and their contents). At the time of the LM IB destruction, three pithoi were being

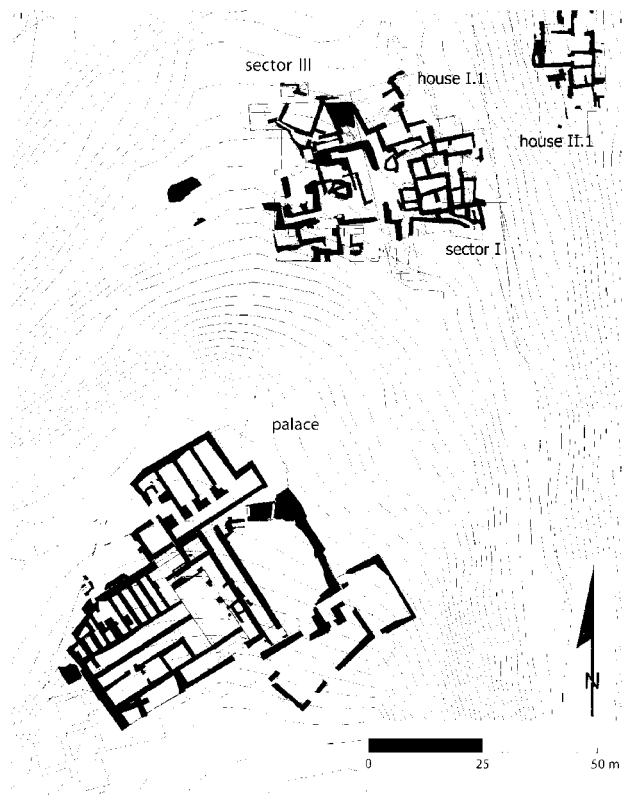

Fig. 1. Topographical map of the excavation at Petras showing the settlement and Palace.

* M. Tsipopoulou is grateful to the Ministry of Culture and the Institute for Aegean Prehistory (INSTAP) for funding both the excavation and the study. The pottery was conserved at the INSTAP Study Center in Pacheia Ammos by C. Zervaki. The excavation photographs are by the author, and those of the pottery are by G. Costopoulou. The drawings are by the author and M.J. Schumacher. The excavation plan is by M. Clontza and M. Wedde.

¹ Tsipopoulou 1990.

² Tsipopoulou 1990.

³ Tsipopoulou forthcoming; Papadatos forthcoming.

⁴ Tsipopoulou 2007.

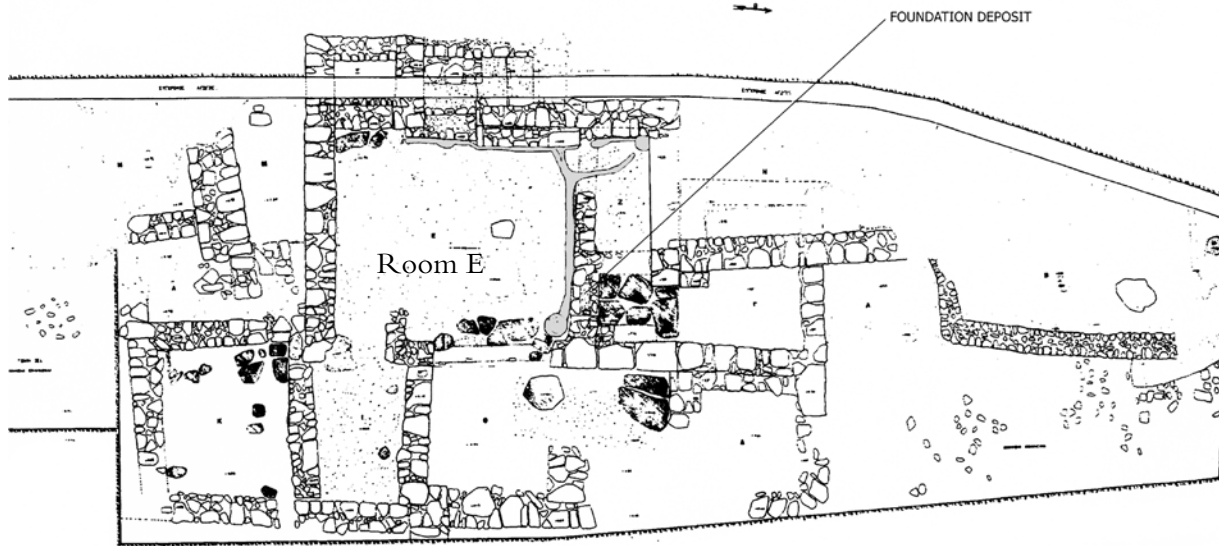

stored in the Central Court, one of which carried a Linear A inscription.⁵ An intense fire is associated with part of the destruction. On the west side of the Central Court, many ashlar blocks, including door jambs, were found fallen from the upper floor, and some of them carried mason's marks. These blocks lay in a deep (ca. 0.80 m), compact layer of burnt mudbricks, plaster, and large amounts of carbonized wood.⁶ After the LM IB destruction, the Palace was abandoned.

An important point to keep in mind when considering the LM IB phase of the Petras Palace is the fact that this building continued to function as a palace from its MM II construction until its final destruction in LM IB. In spite of later alterations to the plan and indications that the LM IB phase may have been a stressful time, both at the site and the surrounding area, the presence of Linear A documents and centralized storage, however, indicate the presence of a palatial administration in LM IB. Moreover, the large houses of the Petras settlement show evidence of various industrial activities, but of very little large-scale storage, suggesting they were dependent on the Palace.

Following the LM IB destruction, the area of the Palace remained unoccupied until LM IIIA1, when two small buildings were constructed on either side of the Central Court. These houses had a different orientation than the earlier monumental structure

and were inhabited until the advanced LM IIIB phase, when they too were destroyed by fire. There are no architectural remains from the subsequent LM IIIC phase (at least in the excavated area of the site), with the exception of a few sherds found on the surface in the area of the Neopalatial North Magazines.⁷

It appears that the hill remained deserted during the Early Iron Age and later antiquity, until the 12th century AD, when a cemetery was established in the area of the Palace. Thirty-three graves of various types have been excavated, and they caused significant damage to the Minoan architectural remains in the area. Many graves were built either using standing Minoan walls or with material from them. Others were cut into the soft bedrock, thereby destroying all earlier remains down to the Early Minoan level. Some graves also cut into the thick LM IB destruction deposit.

It does not appear that the Byzantine cemetery was connected to a church. Various ceremonies, including food consumption and drinking, were conducted near the graves, as indicated by the large number of broken amphorae, drinking cups, and bowls. To give some idea of the mixed nature of the

⁵ Tsipopoulou & Hallager 1996a; 1996b.

⁶ Tsipopoulou 2007.

⁷ Tsipopoulou 2007.



Fig. 3. House II.1 from the southwest.

context, two Linear A inscriptions from the West Wing of the Palace were found almost exclusively with Byzantine pottery. Furthermore, as its name (Petras) indicates, the site has served as a quarry for building material for the general Siteia area since ancient times, though especially in the Middle Ages and more recently. These factors have all caused major disturbances to the Minoan levels on the hill, and consequently, the LM IB deposits of the Palace were not well preserved and were too small to play a significant role in a general discussion on LM IB pottery.

II. House II.1 (M. Tsipopoulou)

At Petras three sectors of the settlement have been excavated to date: I, II and III (Fig. 1). Sector I revealed a large, two-story Neopalatial house, House I.1, which was abandoned in LM IA.⁸ Another large Neopalatial structure, House II.1, was excavated in Sector II. This house was constructed in LM IA and repaired after having been destroyed, probably by an earthquake. In its final phase, which is dated to LM IB, the function of the rooms on the ground floor changed, and the spaces were converted into an industrial area.⁹ House II.1 (Fig. 2) is the only context at Petras with clear and adequate LM IB destruction deposits, and for this reason, it was chosen for presentation at the conference.

In Sector III, which is located immediately to the north and west of Sector I, we had initially hoped to excavate another Neopalatial house, but

the architectural remains were not well preserved. Only three rooms contained adequate floor deposits, and these were dated to LM IA; it is not clear, however, that they belong to the same building.

Although significant evidence for the urban arrangement of the settlement was not uncovered, due to poor preservation in this area, several deep stratigraphic soundings have revealed interesting details for the history of occupation at the site. In contrast to sites like Mochlos, Palaikastro, Gournia, or Zakros, the Neopalatial settlement at Petras has not been extensively excavated. This was the result of both limited funding and our research strategy, which focused primarily on the recovery and study of stratigraphic sequences in order to reconstruct a diachronic history of occupation at the site.

Because the LM IB deposits from the Palace are not substantial, this presentation will focus on the clear LM IB deposits from House II.1 and, in particular, Room E. The architecture and stratigraphy of this building were the focus of Nektaria Mavroudi's MA thesis at the University of Crete.¹⁰

This large, two-story Neopalatial building (Fig. 3) is situated on the lower part of the eastern slope of Petras Hill. Parts of the house were built directly on bedrock, and thus no traces of Protopalatial occupation were preserved in this part of the site. The house was later damaged, probably by an earthquake in LM IA, and then immediately repaired. It

⁸ Tsipopoulou & Dierckx 2006.

⁹ For a description of the building, see Tsipopoulou & Hallager 1996a.

¹⁰ Mavroudi 2004.



Fig. 4. Room E with *gournes* and drains from the northeast.

continued to be occupied, with various modifications to both the plan and function of the ground floor rooms, until its final destruction and abandonment in LM IB. One interesting feature of the LM IB reconstruction is the “ritual (or foundation) deposit” found inside a blocked door in the east wall of Room E (Fig. 2). The offering consisted of a few conical cups and a juglet.

Room E is located on the ground floor of House II.1 and has a roughly square plan. It was initially designed as a Minoan Hall, equipped with a wooden *polytheron*, a large stone bench, and a plaster floor of good quality. A staircase, partially cut in the bedrock, led to rooms on the upper story. In the final phase of the building, Room E was refashioned with a system of drains and *gournes*, which were cut into the floor (Fig. 4). The presence of these features, together with a large number of tripod cooking pots and some portable stone *gournes*, in both Room E and other areas of House II.1, suggest that industrial activities were undertaken in this part of the house. These finds would have been suitable for washing and dyeing wool and the production of aromatics. A *nodulus* inscribed in Linear A came to light in another room of the house; it was inscribed with the pictogram of special (perfumed) oil.¹¹ Some of the conical cups and several loomweights from House II.1 also bear the incised pictogram for cloth.¹² The combination of this evidence suggests that the house may have served as the locus for a local wool industry, probably connected with (and controlled by) the Palace, which is located less than 100 m from House



Fig. 5. House II.1. Room E. The “cupboard” from the southeast.

II.1. One feature noticeably absent from this house was large scale storage.

In the second half of this paper, Alberti presents the large amount of cooking ware and other plain vases, such as kalathoi and conical cups, which were found in House II.1, particularly in Room E. This context offers a unique opportunity at the site to study these shapes, which are otherwise often neglected in reports. It appears that Room E was also provided with a stone cupboard, which probably supported wooden shelves, on which large numbers of cups were stored by shape (Fig. 5).

The upper floor, which appears to have served as the living quarters, contained significant numbers of decorated vessels, some of which were found on the steps of the staircase. These vases are also included in the presentation.

The stratigraphy of Room E consisted of the following levels:

- a) A disturbed layer of surface material containing mixed pottery, some of which had clearly been re-deposited from contexts further up the slope. This material is not included in the present publication.
- b) The upper floor deposit, which contained fragmentary pottery and many fallen stones.
- c) The main floor deposit on the ground floor. Because the bedrock was cut down to serve as the floor surface of the room and then covered by plaster, there were no earlier strata preserved in Room E.

¹¹ Tsipopoulou & Hallager 2006a.

¹² Burke 2006; Tsipopoulou 2007.

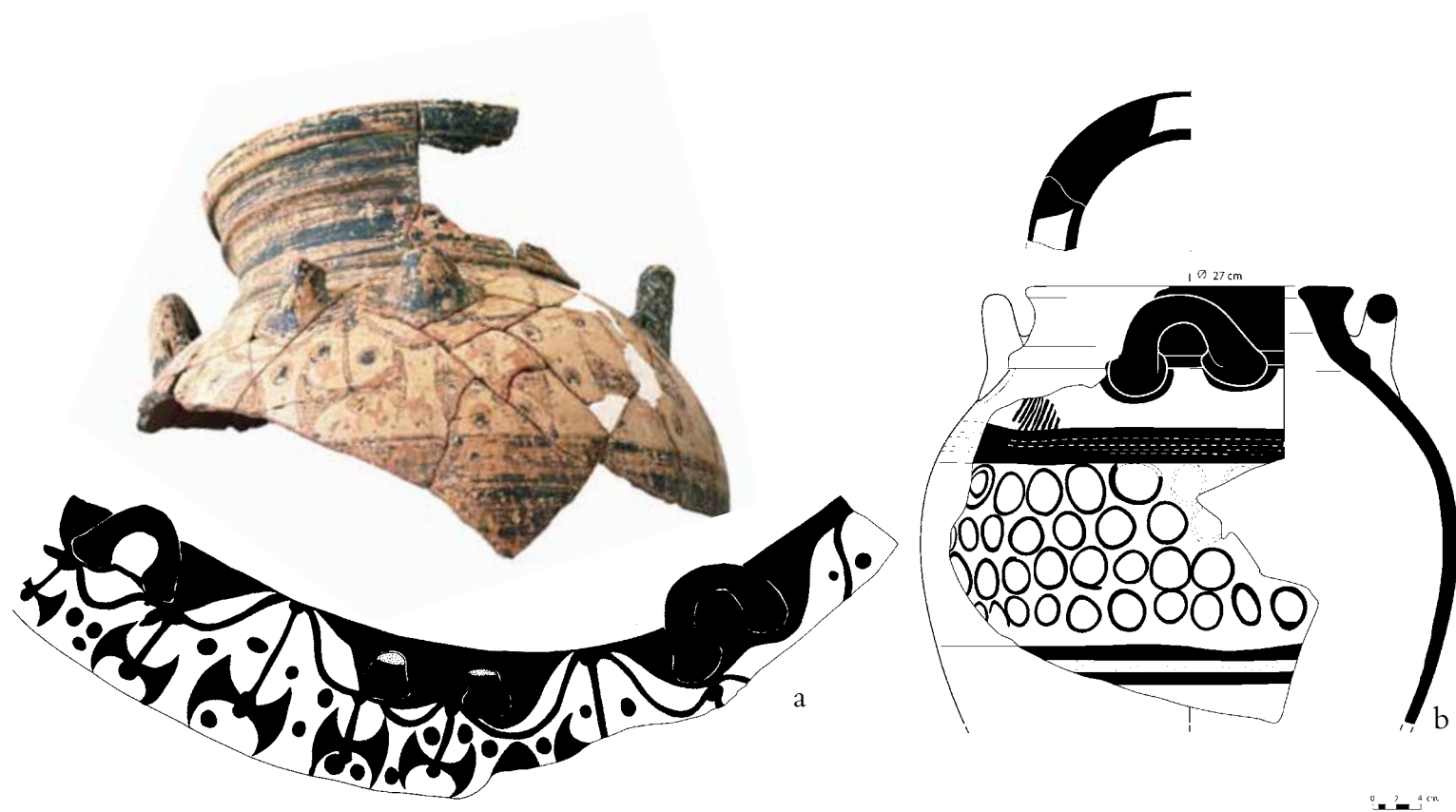

Fig. 6. a) Pithos SM no. 11659; b) pithos P90/1254. (Scale 1:6).

III. The fine ware and non-cooking coarse wares (M. Tsipopoulou)

The total amount of pottery analyzed for this paper weighed 179.250 kg. Inventoried pottery (i.e., complete or fragmentary vessels preserving a full profile) weighed 76.992 kg; this consisted of 26.938 kg from Level 1 (the upper floor level), 35.554 kg from Level 2 (the layer above the floor deposit), and 14.500 kg from Level 3 (the floor deposit). The remaining sherds weighed 102.258 kg, including 67.904 kg from Level 1, 24.730 kg from Level 2, 8.152 kg from Level 3, 0.872 kg from the cupboard, and 0.600 kg from the staircase. The total weights for each level are 94.842 kg for Level 1, 60.284 kg for Level 2, 22.652 kg for Level 3, 0.872 kg for the closet, and 0.600 kg for the staircase.

Shapes

1. Pithoi

It is interesting to note that no medium or large

coarse pithoi of the Minoan type with plastic rope decoration were found in House II.1. This may be an indication that the occupants of the house, who were perhaps specializing in textile production, were dependent on the Palace.¹³ Two fragmentary decorated jars, originally 80 cm in height, were recovered, however. The first (Fig. 6a) has a high, square neck and four horizontal handles on the shoulder. It is decorated with a frieze of pendent double axes and festoons on the upper body.¹⁴ This is one of the most impressive Neopalatial vessels yet recovered at Petras, and the only one with pictorial decoration. It was found on the staircase, having fallen from the upper story. The jar is made of the orange to brown-orange clay that is typical of the Palaikastro area, and it is probably an import from that region. A second medium-sized pithos (Fig. 6b) from the same context was made of similar clay. This vessel has a low neck and four horizontal handles. It

¹³ Christakis 2008, 93, 110.

¹⁴ For a parallel from Zou, see Platon 1956, pl. 112a.

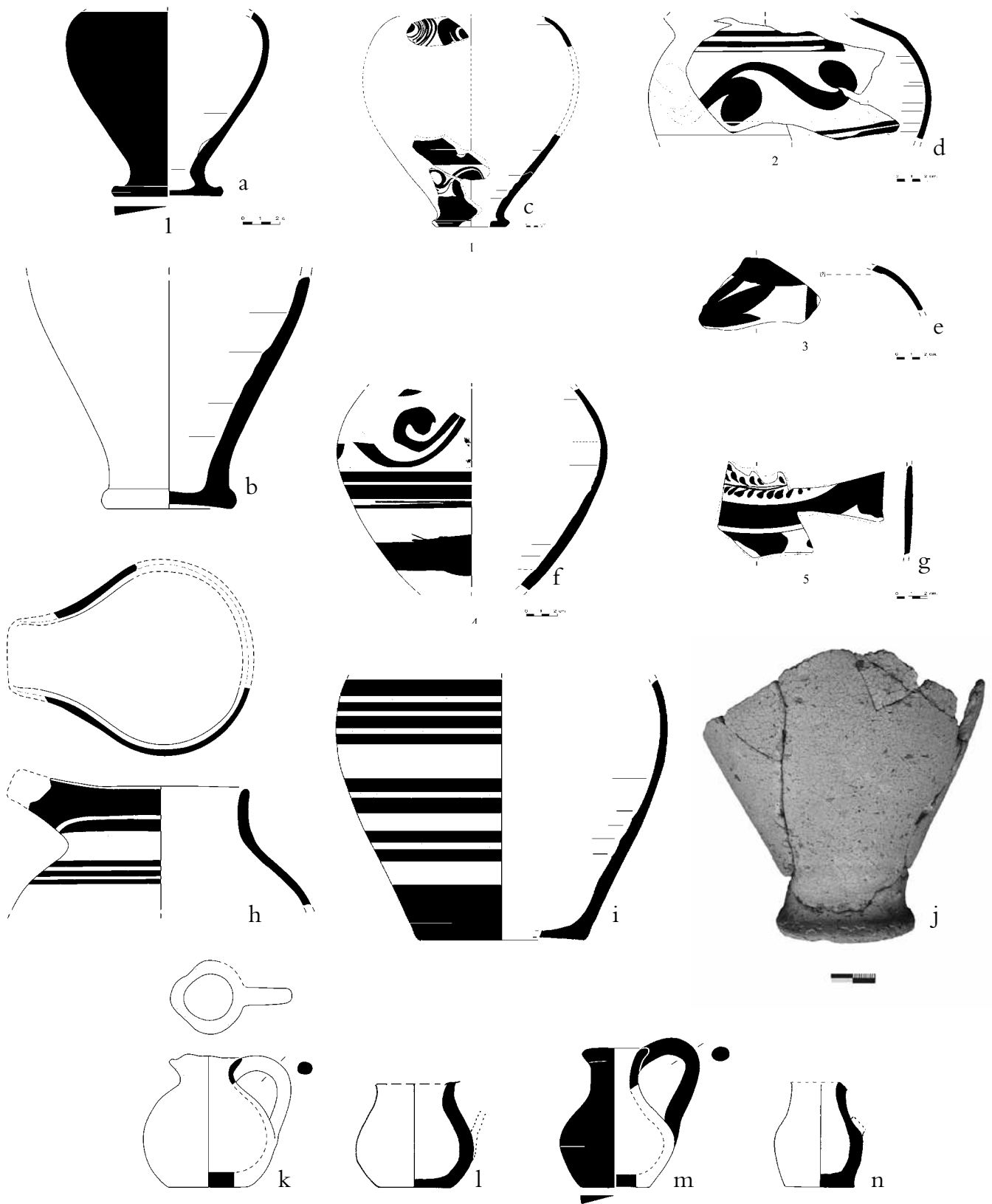

Fig. 7. Jugs: a) P90/424; b) P89/483. Decorated jugs: c) P89/486; d) 90/1559; e) P89/1050; f) P90/1558; g) P90/1544. Wide-mouthed jug: h) P90/1262. Jugs: i) P90/1486; j) P90/862. Miniature jugs: k) P90/269; l) P89/244/12; m) P90/268; n) P89/1052. (c-g not to scale).

was decorated with careless rows of small circles, possibly in imitation of the LM I conglomerate pattern.¹⁵

SM no. 11659. Pithos mended from many sherds. Pres. h. 27 cm, rim d. 28.7 cm. Rim, neck and upper body fragment, two horizontal handles and part of a third. Medium orange clay with many inclusions and a thick gray core; thick yellowish slip; brown-black lustrous worn paint; uneven firing.

P90/1254 Pithos mended from many sherds. Pres. h. 37 cm, max. pres. d. 38 cm. Rim and body fragments, non-joining small fragment from the base. Medium orange clay with many inclusions and a thick gray core; thick yellowish slip; black-brown matte worn paint.

2. Jugs

a) A group of fragmentary jugs was found in the collapsed upper floor deposit. These vessels have narrow torus bases and oval or piriform bodies. Some are plain, while others are decorated with rows of spirals and stylized floral motifs, which find close parallels at Mochlos and Papadiokampos (Fig. 7a-g, j).¹⁶

b) The house also contained wide-mouthed jugs (Fig. 7h) like those reported from the LM IB deposits at Mochlos¹⁷ and House N at Palaikastro.¹⁸ The best preserved example is decorated with brown paint and highlights of added white, which is a rare but not unknown feature in LM IB deposits in eastern Crete.

c) A third type of jug (Fig. 7i) has an oval body and a flat base that is broader than those of the first type.

d) The fourth type of jug includes various miniature forms, which are rare at Petras in general, but not for House II.1. These vessels typically have globular bodies and are unpainted or monochrome (Fig. 7k-n). The preserved rims are trefoil in shape. It is interesting to note that in addition to jugs, House II.1 also contained a variety of miniature vessels (e.g., miniature conical cups, which are discussed below). It is certainly possible that the miniature vessels had a particular function, such as measuring small quantities of some substance, perhaps a special oil or dye. Unfortunately, it was not possible to collect samples for organic residue analysis at the time of excavation. Similar miniature vases have been found in the LM I levels at Papadiokampos and Mochlos, some in foundation deposits.¹⁹

P89/244/12. Jug. Pres. h. 15.7 cm, base d. 4.0 cm. Fine yellowish clay with inclusions; self-slip.

P89/483. Jug mended from five sherds. Pres. h. 13.1 cm, base d. 7.1 cm, max. pres. d. 13.7 cm. Fine yellowish clay with inclusions; thick slip of the same color.

P89/486. Jug, three non-joining fragments. Max. pres. dim. 9.0 x 4.3 cm. Buff, fine clay; thick slip of the same color; red paint. Parallels for the shape from Mochlos (Barnard & Brogan 2003, fig. 54, IB.620); for similar spirals, also from Mochlos (*supra* fig. 22, IB.322).

P89/1050. Jug. Body fragment. Max. pres. dim. 7.0 x 5.8 cm. Orange buff, fine clay; thick slip of the same color; reddish-brown paint; uneven firing.

P89/1052. Miniature jug. H. 6.4 cm. Buff medium clay with inclusions and a gray core; self-slip.

P90/268. Miniature jug mended from two sherds. H. 7.6 cm, base d. 4.0 cm, rim d. 3.8 cm, max. d. 6.2 cm. Yellowish fine clay; self-slip; black paint, ranging to reddish; uneven firing (similar to Barnard & Brogan 2003, fig. 24, IB.333, pl. 14).

P90/269. Miniature jug. H. 7.7 cm, base d. 4.0 cm, rim d. 3.8 cm, max. d. 6.2 cm. Fine yellowish clay; self-slip; traces of brown matte paint suggesting it was monochrome.

P90/424. Jug. Pres. h. 9.3 cm, base d. 6.0 cm, max. pres. d. 11.2 cm. Fine orange clay with few inclusions; orange worn paint (cf. Barnard & Brogan 2003, fig. 54, IB.620).

P90/862. Jug. Pres. h. 22 cm, base d. 7.7 cm. Medium yellowish clay; self-slip.

P90/1262. Side-spouted jug mended from three sherds. Pres. h. 4 cm, rim d. 12.6 cm. Buff fine clay; self-slip; reddish-brown paint; uneven firing (cf. similar profile and decoration in Barnard & Brogan 2003, fig. 22, IB.320; fig. 23, IB.323, IB.326).

P90/1486. Jug mended from seven sherds. Max. pres. dim. 12.8 x 12.4 cm. Fine orange clay with few inclusions; buff, thick slip; brown lustrous paint and added white paint (cf. identical profile with a similar system of bands on the lower body in Barnard & Brogan 2003, fig. 20, IB.308).

P90/1544. Jug mended from five sherds. Max. pres. dim. 9.6 x 6.8 cm. Fine orange buff clay; self-slip; reddish-brown paint; uneven firing (for similar decoration on a

¹⁵ For a parallel from Ialysos, see Niemeier 1980, 38, no. 6 (dated Sub-LM IA).

¹⁶ Barnard & Brogan 2003, figs. 21–3; Brogan, Sofianou & Morrison in this volume.

¹⁷ Barnard & Brogan 2003, figs. 22–3.

¹⁸ Sackett & Popham 1970, figs. 11, 14.

¹⁹ Pers. comm. with Ch. Sofianou & T. Brogan; for the shapes, see Barnard & Brogan 2003, fig. 18, IB.306; fig. 28, IB.366, IB.367.

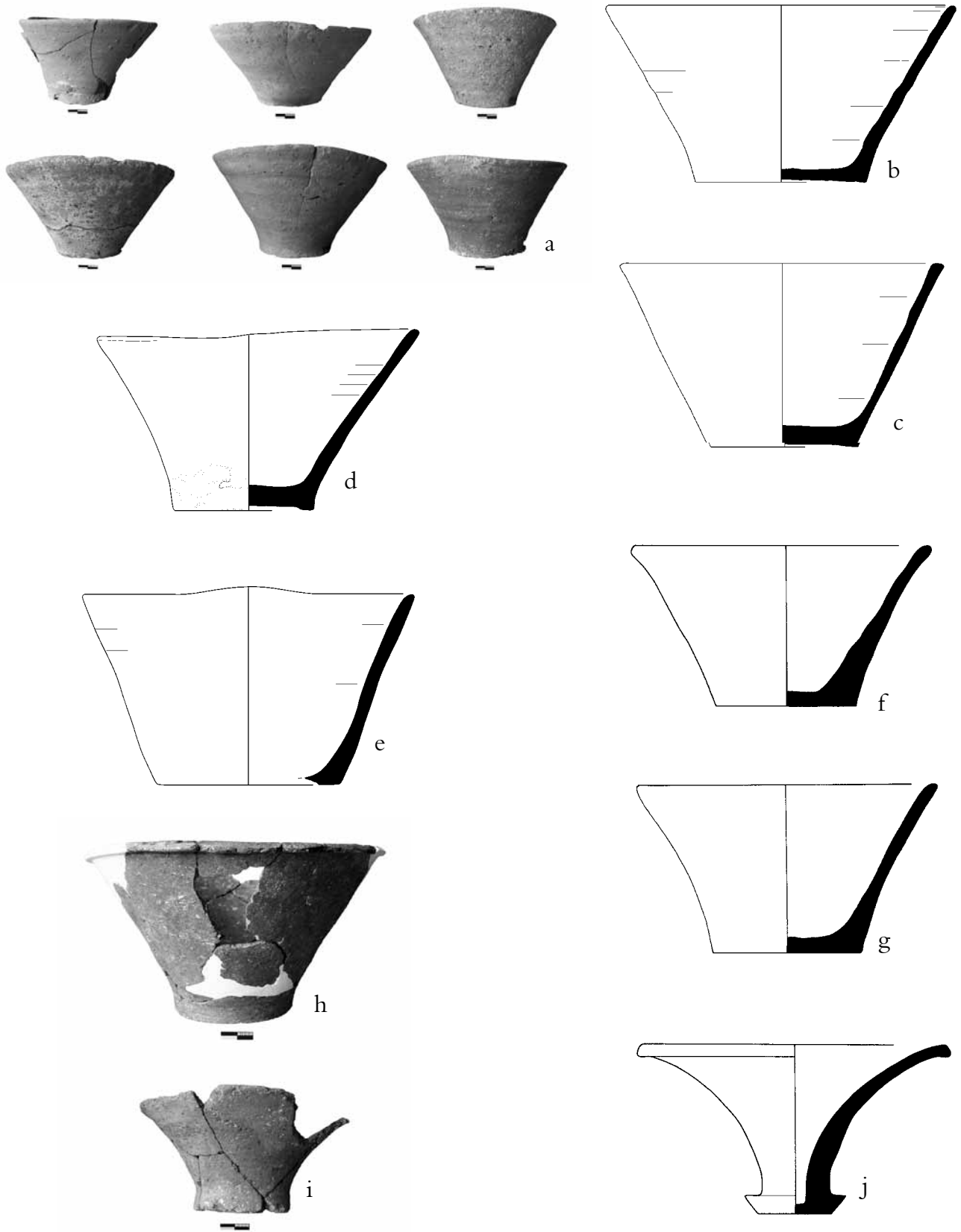

Fig. 8. Kalathoi from floor of Room E: a) Type 1: b) P89/478; c) P90/808. Type 2: d) P90/1526; e) P90/1037. Type 3: f) P90/267; g) P90/890. Type 4: h) P89/484; i) P90/1482. Type 5: j) P90/921.

side-spouted jug from Mochlos, see Barnard & Brogan 2003, fig. 27, IB.353).

P90/1558. Side-spouted jug. Max. pres. dim. 7.2 x 9.5 cm. Fine buff clay; thick slip of the same color; red paint ranging to brown-black and added white paint; uneven firing (for a similar arrangement of a different type of spiral, see Barnard & Brogan 2003, fig. 23, IB.326; for a similar arrangement of bands on the lower body, *supra*, fig. 23, IB.323).

P90/1559. Jug mended from six sherds. Max. pres. dim. 7.6 x 12.4 cm. Fine buff clay; thick slip of the same color; brown-reddish lustrous paint and added white paint.

3. Kalathoi

A large number of kalathoi were found on the floor of Room E (Fig. 8a). This shape, with a flat base, conical body and rounded or thin rim, is uncommon at other sites in LM IB. All examples are made of medium clay with many inclusions, are self-slipped, and show wheel marks, especially on the interior surface. The clay is always medium, either the Petras yellowish variety or the orange of Palai-kastro. The kalathoi are all slipped, but never decorated. Their heights vary between 7.8 and 10 cm, with the majority measuring from 9 to 9.9 cm; base diameters vary between 5 and 9.5 cm, with the majority from 7.5 to 8 cm, and the rim diameters vary between 15.7 and 18.2 cm, with the majority from 17.5 to 18 cm.

In House II.1, the kalathoi can be sorted by capacity, suggesting a potential connection with a special industrial activity located in Room E. One possibility is that these vessels were used to measure different weights or volumes of a liquid or solid material. The first group (Fig. 8b-c) has a capacity of 1.2 liters, while the second group (Fig. 8d-e), which includes slightly coarser examples, has a capacity of 1 liter. The third group (Fig. 8f-g), with a more convex profile, has a capacity of 0.8 liter. A final group includes two kalathoi made of medium red clay with pronounced flaring rims. One has a capacity of 1.8 liters and the other of 0.6 (1/3 the capacity of the larger vessel) (Fig. 8h-i). This shape is unusual at Petras, but a close parallel was found at Kamilari.²⁰ Another version, which is similar in shape and made from the same red clay, has a pronounced, narrow torus base, and could actually be called a fruit stand (Fig. 8j). This last example was

originally on the upper floor of the building, and therefore probably used for a different purpose than the kalathoi on the ground floor.

P89/478. Kalathos. H. 9.3 cm, base d. 9.1 cm, rim d. 18.2 cm. Reddish medium clay with inclusions; self-slip.

P89/484. Kalathos, mended from 20 sherds. H. 12.2 cm, base d. 8.2 cm, rim d. 19.8 cm. Reddish medium clay with many inclusions; self-slip.

P90/267. Kalathos. H. 9 cm, base d. 7.5 cm, rim d. 17 cm. Orange medium clay; self-slip.

P90/808. Kalathos rim mended from three sherds. Pres. h. 7.8 cm. Brown medium clay; self-slip.

P90/816. Kalathos. H. 8.4 cm, base d. 5 cm, rim d. 18–19 cm. Orange medium clay; self-slip.

P90/855. Kalathos. H. 9.2 cm, base d. 7.6 cm, rim d. 18 cm. Yellowish-orange medium clay; self-slip.

P90/857. Kalathos mended from eight sherds. H. 10 cm, base d. 7.2 cm, rim d. 18.2 cm. Orange-grayish medium clay; self-slip.

P90/869. Kalathos. H. 9.2 cm, base d. 8.7 cm. Yellowish medium clay; self-slip.

P90/890. Kalathos. H. 9 cm, base d. 8.2 cm, rim d. 17.5 cm. Yellow-grayish medium clay; self-slip.

P90/921. Kalathos base. H. 9 cm, base d. 6 cm. Yellowish medium clay; self-slip.

P90/1037. Kalathos. H. 9.4 cm, base d. 7.4 cm. Dark orange medium clay; self-slip.

P90/1482. Kalathos rim mended from eight sherds. H. 9 cm, base d. 7.1 cm, rim d. 17 cm. Reddish medium clay with many inclusions; self-slip.

P90/1526. Kalathos base mended from nine sherds. H. 9.8 cm, base d. 10 cm. Light orange medium clay; self-slip.

4. Cups

Room E contained a large number of decorated and undecorated cups of various types.

a) Decorated conical, handleless cups (Fig. 9a-c). The bases of these cups are not preserved, but they were probably similar to those from Mochlos.²¹ The bodies are conical or with a slightly convex profile. The clay is fine and varies in color from buff to buff orange or reddish-brown. The slip is buff, while the paint is red or reddish-brown. The exterior surfaces are decorated with zones of linear motifs like spirals, rows of solid circles, or careless zig-zags, while the interiors are monochrome.

²⁰ La Rosa & Cucuzza 2001, fig. 260, XX-17.

²¹ Barnard & Brogan 2003, fig. 3, IB.149, IB.156; fig. 9, IB.229.

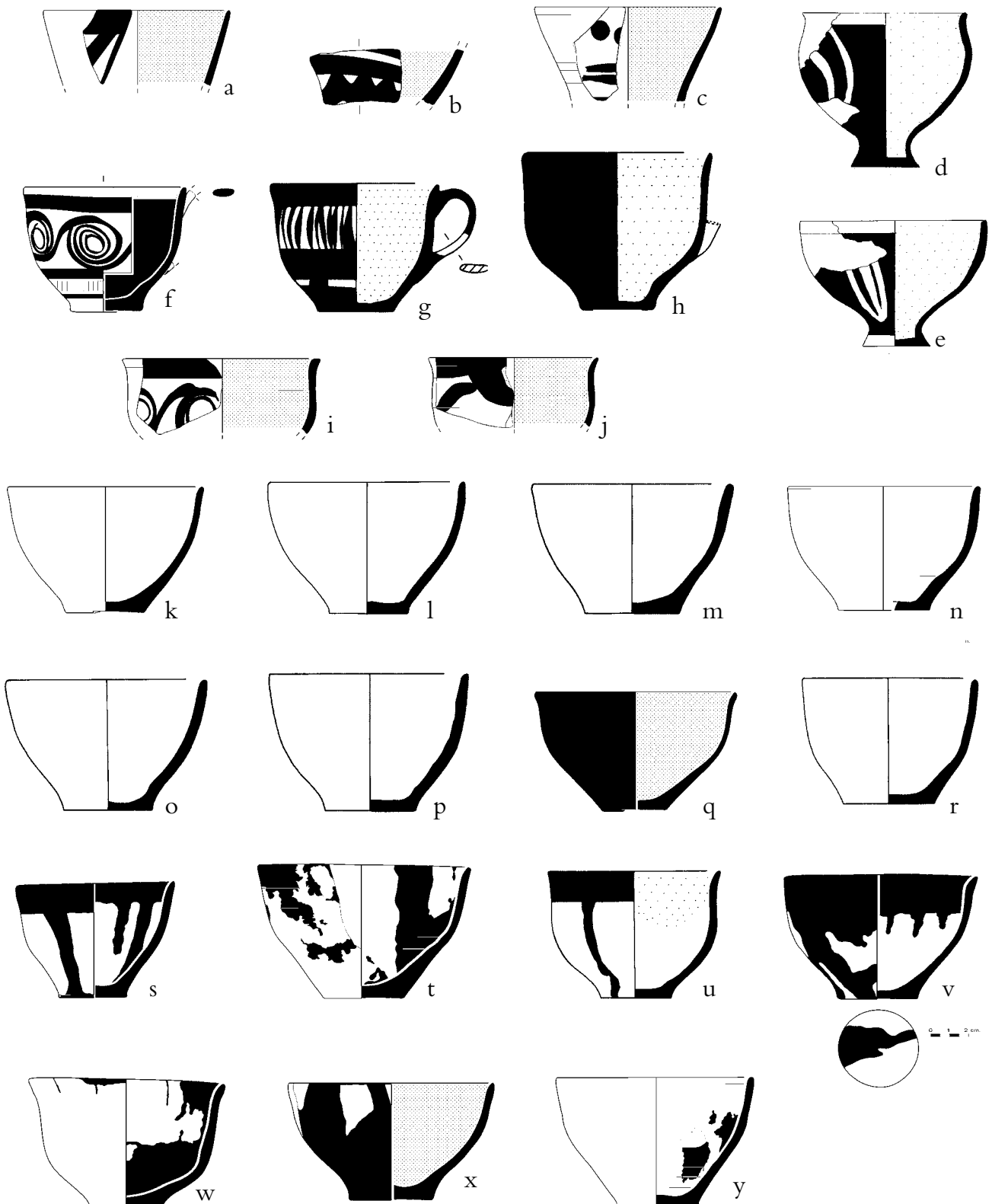

Fig. 9. Cups. Conical cups with painted decoration: a) P90/1537; b) P90/141/5; c) P89/1053. Globular cups with light-on-dark decoration: d) P90/861; e) P90/1472. One-handed decorated bell cups: f) P90/626; g) P90/1023; h) P90/357; i) P90/103/1+5; j) 89/189/4. Plain ogival cups: k) P90/408; l) P90/1025; m) P90/602; n) P89/1041; o) P90/894; p) P89/552; q) P89/477; r) P90/875. Ogival cups decorated with dribbles: s) P90/1535; t) P90/1499; u) P90/225; v) P90/950; w) P90/459; x) P89/601; y) P90/1521.

P89/1053. Cup rim and body fragment. Max. pres. dim. 6.8 x 2.6 cm. Fine buff clay; self-slip; reddish-brown paint.

P90/141/5. Cup body fragment. Max. pres. dim. 2.9 x 4.8 cm. Fine buff clay; self-slip; red paint.

P90/1537. Cup rim and body fragment. Max. pres. dim. 4.1 x 2.2 cm. Fine buff clay; thick slip of the same color; red matte worn paint.

b) A particularly rare type of LM IB cup (Fig. 9d-e) was found in Room E of House II.1. It has a depressed semiglobular body, a pronounced low foot, and was decorated with simple curvilinear motifs in light-on-dark. The clay is fine and brown in color, and is probably not local to Petras. The paint is dark brown and matte, while the motif is added in white paint. The closest parallels come from Mochlos, where the vessel also does not commonly occur.²²

P90/861. Cup base and rim. Max. pres. dim. 7.8 x 4 cm. Fine brown clay; self-slip; dark brown matte paint and added white paint.

P90/1472. Cup. H. 7.4 cm, rim d. 9.2 cm. Fine brown clay; self-slip; dark brown matte paint and added white paint.

c) One-handled, decorated bell cups (Fig. 9f-j) have a slightly raised base, out-curving rim, and handle that is elliptical in section. Their heights range between 5.4 and 6.7 cm, the base diameters between 3.0 and 3.8 cm, and the rim diameters between 6.8 and 7.6 cm. The clay is fine and of buff or yellowish color. The cups are usually self-slipped, and in one case, the slip is thick and of the same color as the clay. Some examples are monochrome on the interior and exterior. The paint is black or reddish-brown, and the decoration, arranged in a single zone, covers most of the body surface. The motifs include spirals, vertical strokes, and a stylized floral motif.

P89/189/4. Cup rim. Max. pres. dim. 3.9 x 4.7 cm. Fine buff clay; self-slip; reddish-black worn paint.

P90/103/1+5. Cup rim. Max. pres. dim. 3.7 x 7.7 cm. Fine buff-orange clay; buff slip; reddish-brown very worn paint; uneven firing. Similar in shape and decoration to cups from Mochlos, which also have a monochrome interior (Barnard & Brogan 2003, fig. 6).

P90/357. Cup. H. 5.4 cm, base d. 3.4 cm, rim d. 6.8 cm. Fine buff clay; self-slip; brown paint; uneven firing.

P90/626. Cup. H. 6.3 cm, base d. 3.8 cm, rim d. 7.3 cm. Fine yellowish clay; thick slip of the same color; black

worn paint and added red paint (cf. Barnard & Brogan 2003, fig. 9, IB.225).

P90/1023. Cup. H. 6.7 cm, base d. 3 cm, rim d. 7.6 cm. Fine buff clay; self-slip; reddish-brown paint; uneven firing.

d) Plain ogival cups (Fig. 9k-r) are not as common as handleless conical cups, though they are made of the same clay. There are 47 examples preserving a full profile and at least 379 additional fragmentary examples. The first group of ogival cups consists of two undecorated types with similar profiles. Another group (Fig. 9s-y) is decorated with dribbles or splashes of paint, or was dipped in paint. This decoration first appears at Petras at the beginning of Middle Minoan I and remains popular in the Protopalatial and Neopalatial periods. The dipped version has also been found at Mochlos in LM IB.²³ A third group with both a monochrome interior and exterior includes the majority of the ogival cups (Fig. 10a-l); in a few cases, these cups are monochrome on the exterior with a band on the interior.

P89/473. Ogival cup. H. 7.6 cm, base d. 4.2 cm. Fine orange buff clay with inclusions; self-slip.

P89/477. Ogival cup. H. 6.7 cm, base d. 3.7 cm, rim d. 10.2 cm. Fine orange-buff clay; self-slip.

P89/552. Ogival cup mended from five sherds. H. 7.2 cm, base d. 4 cm, rim d. 11 cm. Fine buff clay; self-slip.

P89/554. Ogival cup. H. 6.2 cm, base d. 4 cm. Fine yellowish clay with inclusions; self-slip.

P89/601. Ogival cup. H. 6 cm, base d. 4.3 cm. Fine buff-orange clay; self-slip.

P89/1041. Ogival cup. H. 6.7 cm, base d. 4.3 cm, rim d. 9.5 cm. Fine orange clay; self-slip.

P90/225. Ogival cup. H. 8.8 cm, base d. 3.9 cm, rim d. 10 cm. Fine orange clay; self-slip; brown-black worn paint; uneven firing.

P90/408. Ogival cup. H. 6.5 cm, base d. 4.1 cm. Fine buff-orange clay with inclusions; buff slip.

P90/459. Ogival cup. H. 6.7 cm, base d. 4.2 cm, rim d. 10.6 cm. Fine yellowish clay; self-slip; brown-black worn paint; uneven firing (for the shape, see Barnard & Brogan 2003, fig. 4, IB.161).

P90/602. Ogival cup. H. 6.4 cm, base d. 4.4 cm. Fine buff clay; black worn matte paint.

P90/819. Ogival cup. H. 6.7 cm, base d. 4.7 cm, rim d. 10.3 cm. Fine buff clay with few inclusions; self-slip; orange worn paint.

²² Barnard & Brogan 2003, fig. 5, IB.187, IB.189.

²³ Barnard & Brogan 2003, fig. 5, IB.197.

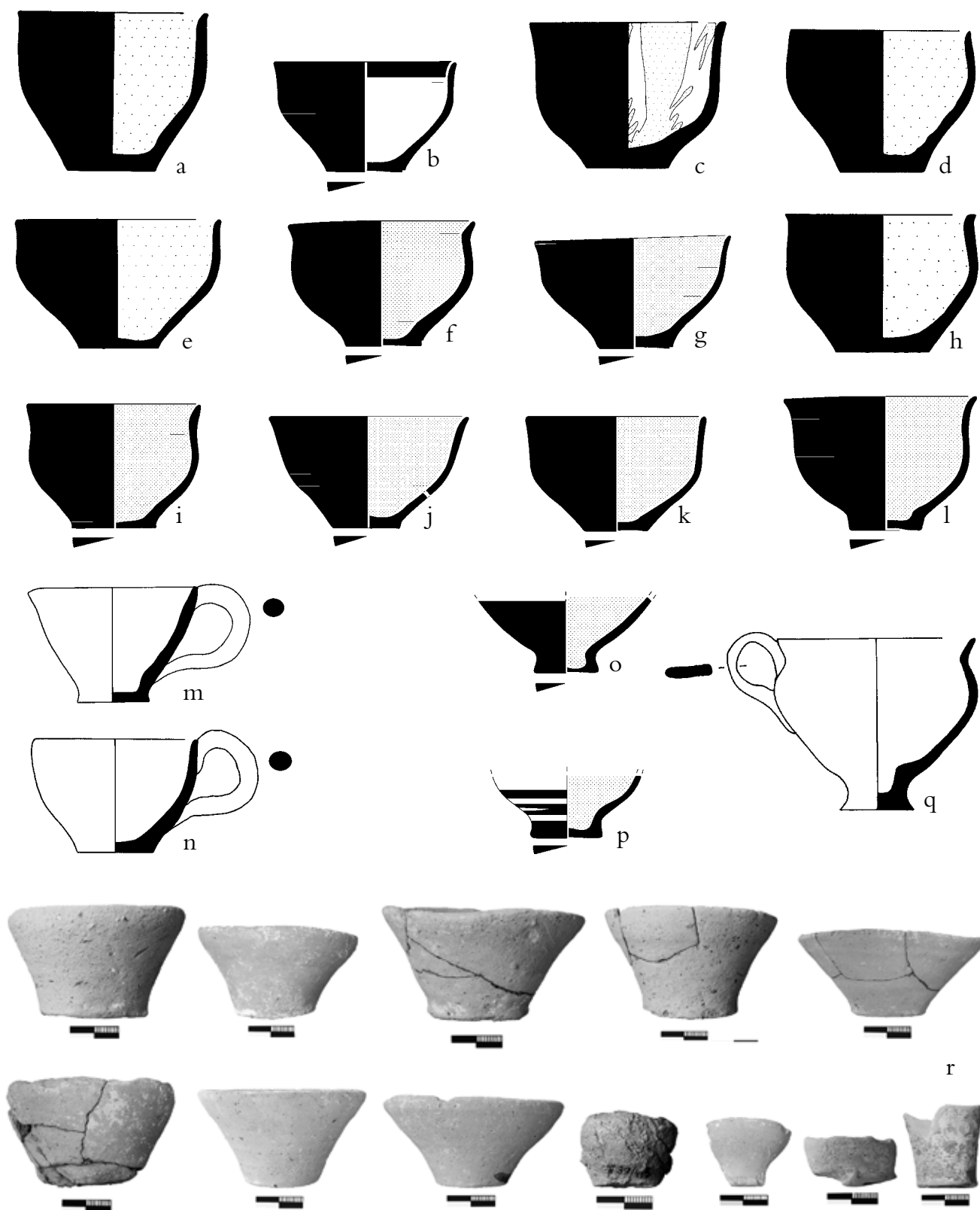

Fig. 10. Monochrome ogival cups: a) P89/473; b) P90/819; c) P90/950; d) P89/554; e) P90/910; f) P90/952; g) P90/1040; h) P90/990; i) P90/1477; j) P90/1511; k) P90/954; l) P90/951. Not to scale. One-handed conical cups: m) P90/343; n) P90/1016. One-handed (or handleless) footed cups: o) P90/428, p) P90/87/2, q) P90/1020. Conical cups: r).

- P90/854.** Ogival cup mended from seven sherds. H. 7 cm, base d. 3.8 cm, rim d. 10.3 cm. Fine pinkish clay; whitish slip.
- P90/871.** Ogival cup mended from two sherds. H. 5.9 cm, base d. 4.6 cm, rim d. 9.9 cm. Fine buff clay; self-slip; brown paint, ranging to black; uneven firing.
- P90/875.** Ogival cup mended from six sherds. H. 6.7 cm, base d. 5 cm, rim d. 10 cm. Fine buff clay; self-slip.
- P90/894.** Ogival cup. H. 6.8 cm, base d. 4.4 cm, rim d. 10.2 cm. Orange medium clay; self-slip.
- P90/907.** Ogival cup mended from three sherds. H. 6.7 cm, base d. 3.7 cm. Orange fine clay with few inclusions; self-slip; orange-reddish paint, ranging to brown and black; uneven firing.
- P90/910.** Ogival cup. H. 5.8 cm, base d. 3.8 cm. Fine yellowish clay; self-slip.
- P90/950.** Ogival cup. H. 7 cm, base d. 3.7 cm, rim d. 9.9 cm. Fine light orange clay; thin slip that is lighter than the clay; brown-black worn paint; uneven firing.
- P90/951.** Ogival cup. H. 7.2 cm, base d. 4 cm, rim d. 9.7 cm. Fine orange clay; orange paint ranging to dark brown and black; uneven firing.
- P90/952.** Ogival cup. H. 6.6 cm, base d. 4 cm, rim d. 9.5 cm. Fine buff clay; worn black matte paint.
- P90/954.** Ogival cup mended from six sherds. H. 3.8 cm, base d. 4 cm, rim d. 8.5 cm. Fine buff clay with inclusions; self-slip.
- P90/1025.** Ogival cup mended from 14 sherds. H. 6.8 cm, base d. 4.1 cm, rim d. 10.4 cm. Orange medium clay; thick slip of the same color.
- P90/1040.** Ogival cup. H. 6 cm, base d. 4.4 cm. Orange medium clay; self-slip.
- P90/1477.** Ogival cup. H. 5.4 cm, base d. 3.6 cm. Fine buff clay with inclusions; self-slip.
- P90/1511.** Ogival cup. H. 6.4 cm, base d. 4 cm. Fine yellowish clay; buff slip.
- P90/1521.** Ogival cup. H. 7.1 cm, base d. 4.5 cm, rim d. 10.8 cm. Fine yellowish clay; self-slip; traces of black paint on the interior surface.
- P90/1534.** Ogival cup mended from four sherds. H. 5.6 cm, base d. 3.7 cm. Fine buff clay with few inclusions; thin slip, lighter in color than the clay; dark brown-black paint; uneven firing.
- P90/1535.** Ogival cup mended from four sheds. H. 5.9 cm, base d. 3.7 cm. Fine buff clay with few inclusions; self-slip.

e) One-handled conical cups (Fig. 10m-n) form a small group. They are made of medium orange clay with rather thick walls and are unpainted.

- P90/343.** Cup. H. 6.4 cm, base d. 4.2 cm, rim d. 9.4 cm. Fine light orange clay with few inclusions; self-slip (for a parallel from Mochlos with a band on the rim, see

Barnard & Brogan 2003, fig. 3, IB.157).

- P90/1016.** Cup. H. 6 cm, base d. 4.1 cm, rim d. 9.8 cm. Buff-orange medium clay; self-slip.

f) One-handled (or handleless) footed cups represent (Fig. 10o-q) a shape common in LM IB. These cups are important chronological markers because none have yet been found at Petras in contexts associated with the LM IA destruction, but instead they have only been recovered in the LM IB levels of Room E. A complete footed cup was recovered from the cupboard. Most are plain or monochrome, but one example is decorated with bands on the lower body below a frieze of spirals or schematized floral ornament.²⁴

- P90/87/2.** Footed cup. Pres. h. 6 cm, base d. 4.1 cm. Fine orange clay; self-slip; reddish paint.
- P90/428.** Footed cup. Pres. h. 7.8 cm, base d. 3.9 cm. Fine orange clay; uneven firing.
- P90/1020.** One-handled footed cup. H. 9.4 cm, base d. 4 cm, rim d. 10 cm. Orange medium clay; self-slip; worn surface.

g) Conical cups

Handleless conical cups (Fig. 10r) were found in large numbers in Room E. Some had fallen from the upper floor, but most were found on the ground floor, some inside tripod cooking pots or carefully stored in the cupboard in the corner of the room. There are 118 examples preserving a complete profile, and we estimate the existence of another 1,770 from the sherd material. Compared to the ogival cups, there are 2.5 times more conical cups among the complete examples and 4.6 times as many among the sherds. Conical cups can be divided into eight types, the last of which includes miniature examples with a capacity of only a few milliliters. The clay is either fine or medium but contains very few inclusions and impurities. It is usually orange, brown, or buff, and only rarely the yellowish Petras clay. All examples are self-slipped, and wheel marks are visible on the interior surfaces and also often on the exterior surfaces. Very often the conical cups have fingerprints and marks from

²⁴ Cf. Sackett & Popham 1970, fig. 13; Barnard & Brogan 2003, fig. 5.

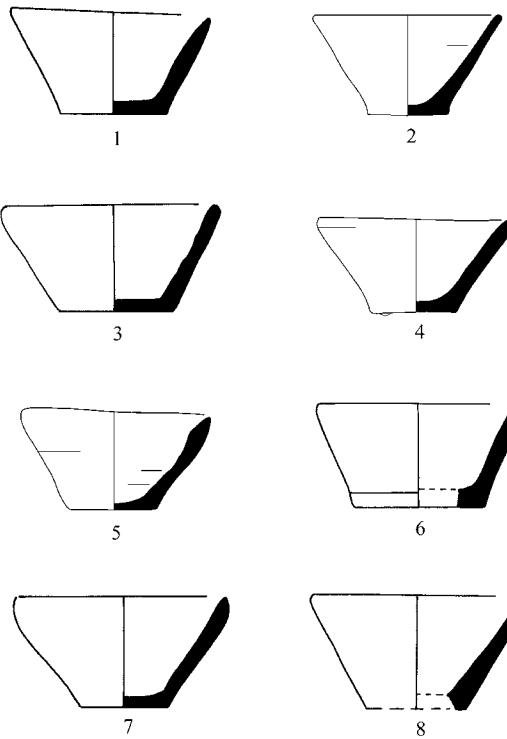

Fig. 11. Conical cups Type 1: 1) P89/466; 2) P89/613; 3) P90/403; 4) P90/1478; 5) P90/851; 6) P90/867; 7) P89/576; 8) P90/384.

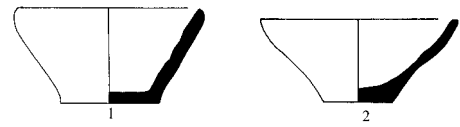

Fig. 12. Conical cups Type 2: 1) P90/350; 2) P89/482.

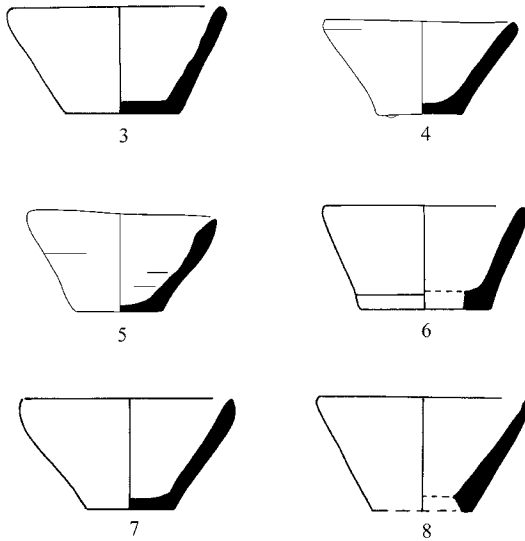

Fig. 13. Conical cups Type 3: 1) P90/1522; 2) P90/864; 3) P90/1021; 4) P89/467; 5) P90/896; 6) P90/905.

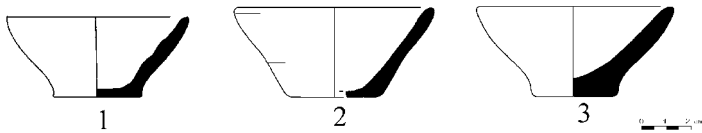

Fig. 14. Conical cups Type 4: 1) P90/508; 2) P90/495; 3) P90/351.

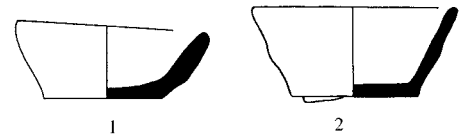

Fig. 15. Conical cups Type 5: 1) P90/334; 2) P90/865.

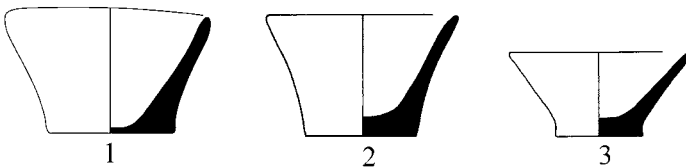

Fig. 16. Conical cups Type 6: 1) P90/1017; 2) P90/915; 3) P90/348.

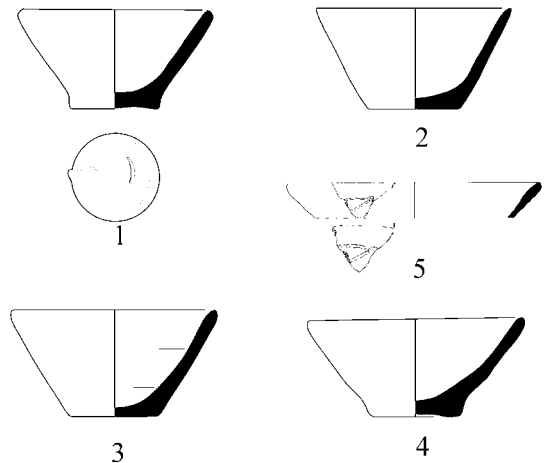

Fig. 17. Conical cups Type 7: 1) P90/1514; 2) P90/1276; 3) P90/1513; 4) P90/1498; 5) P90/1271.



Fig. 18. Conical cup Type 7 with incised ideogram for cloth: P90/1271.

the sponge used to smooth the exterior surface and to apply the slip.

1) The first type (Fig. 11) has a rather shallow conical body, flat base, and a rounded or thin rim. This type is not unknown, though it is rather uncommon at Mochlos.²⁵

P89/466. Handleless conical cup. H. 3 cm, base d. 3.1 cm. Orange medium clay. Self-slip.

P89/576. Handleless conical cup. H. 4.5 cm, base d. 3.7 cm. Fine yellowish clay with inclusions; self-slip.

P89/613. Handleless conical cup. H. 4 cm, base d. 3.1 cm. Orange medium clay; self-slip.

P90/384. Handleless conical cup. H. 4.3 cm, base d. 3 cm. Orange medium clay; self-slip.

P90/403. Handleless conical cup. H. 3.9 cm, base d. 3.4 cm, rim d. 7.1 cm. Orange medium clay; self-slip.

P90/851. Handleless conical cup. H. 3.8 cm, base d. 3.6 cm. Orange medium clay; self-slip.

P90/867. Handleless conical cup. H. 3.8 cm. Orange medium clay; self-slip.

P90/1478. Handleless conical cup. H. 3.5 cm, base d. 3.5 cm. Yellowish medium clay; self-slip.

2) The second type of conical cup (Fig. 12) is also rather shallow and is characterized by an incurving rim. This type is somewhat rare, with only five complete examples. The body has an S-profile, though not very pronounced, while the rounded rim follows the profile of the body.

P89/482. Handleless conical cup mended from three fragments. H. 3.9 cm, base d. 3.5 cm, rim d. 8 cm. Fine buff clay with many inclusions; self-slip.

P90/350. Handleless conical cup. H. 4.5 cm, base d. 4.2 cm. Buff-orange medium clay with inclusions; self-slip.

3) The third type of conical cup (Fig. 13) is deeper than the first two and has a conical body with a poorly formed rim.

P89/467. Handleless conical cup. H. 4 cm, base d. 3.7 cm. Orange medium clay with many inclusions; self-slip.

P90/864. Handleless conical cup. H. 3.5 cm, base d. 2.6 cm. Buff medium clay; self-slip (cf. Barnard & Brogan 2003, fig. 1, IB.10).

P90/896. Handleless conical cup. H. 4.7 cm, base d. 3.9 cm. Buff medium clay; self-slip.

P90/905. Handleless conical cup. H. 4.3 cm, base d. 3.2 cm, rim d. 8.1 cm. Orange medium clay with inclusions; self-slip.

P90/1021. Handleless conical cup. H. 3.6 cm, base d. 3.6

cm, rim d. 7.9 cm. Fine orange clay with inclusions; thin slip that is lighter than the clay.

P90/1522. Handleless conical cup. H. 4 cm, base d. 4 cm. Orange medium clay; self-slip.

4) Type 4 (Fig. 14) examples are rather shallow with an S-shaped body profile and a thin rim.

P90/351. Handleless conical cup. H. 3.2 cm, base d. 3 cm. Yellowish medium clay with inclusions; self-slip.

P90/495. Handleless conical cup. H. 4.3 cm, base d. 3.8 cm. Fine buff clay with few fine inclusions; self-slip (cf. Barnard & Brogan 2003, fig. 2, IB.64).

P90/508. Handleless conical cup. H. 4.5 cm, base d. 4 cm. Orange medium clay with inclusions; self-slip.

5) Type 5 (Fig. 15) includes a few shallow examples with thick walls and careless execution. The rim is rounded and follows the profile of the body.

P90/334. Handleless conical cup. H. 3.4 cm, base d. 4.6 cm, rim d. 7.6 cm. Fine buff clay; self-slip.

P90/865. Handleless conical cup. H. 3.4 cm, base d. 5.2 cm, rim d. 8.2 cm. Yellowish medium clay with various inclusions; self-slip.

6) Type 6 (Fig. 16) consists of conical cups with a raised, well-formed base, a slightly convex profile and a thin, slightly incurving rim.

P90/348. Handleless conical cup. H. 4.6 cm, base d. 4.2 cm. Orange medium clay; self-slip.

P90/915. Handleless conical cup. H. 4.4 cm, base d. 4.6 cm, rim d. 8.4 cm. Yellowish medium clay; self-slip.

P90/1017. Handleless conical cup. H. 4.8 cm, base d. 5 cm, rim d. 8 cm. Fine buff clay; self-slip.

7) Type 7 (Figs. 17–18) includes shallow cups with a rounded rim.

P90/1271. Handleless conical cup. Max. pres. dim. 3.3 x 3.8 cm. Fine orange clay with inclusions; self-slip.

P90/1276. Handleless conical cup mended from five sherds. H. 4 cm. Fine orange clay; self-slip.

P90/1498. Handleless conical cup. H. 3.4 cm, base d. 3.2 cm. Orange medium clay; self-slip.

P90/1513. Handleless conical cup. H. 3.8 cm, base d. 3.2 cm. Yellowish medium clay; self-slip.

P90/1514. Handleless conical cup. H. 3.9 cm, base d. 3.7 cm. Orange medium clay; self-slip.

8) The Type 8 conical cup (Fig. 19) is small in size and has a conical body profile. The rims are cut horizontally, and the bases are flat or slightly raised.

²⁵ Barnard & Brogan 2003, fig. I, IB.12.

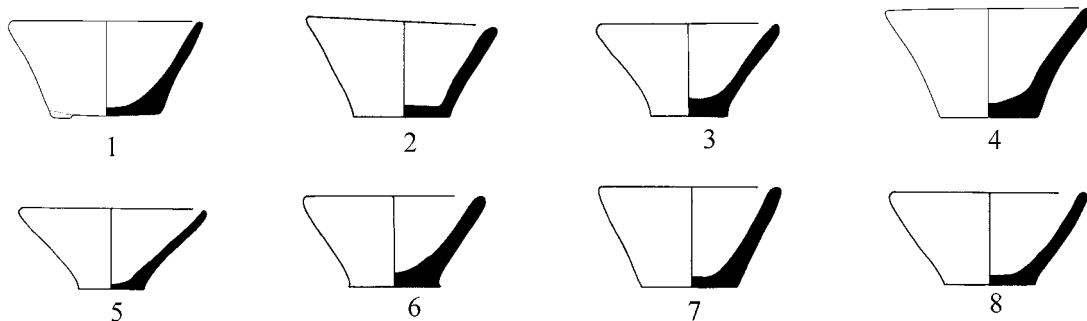

Fig. 19. Conical cups Type 8: 1) P89/515; 2) P90/846; 3) P90/1026; 4) P90/850; 5) P90/1467; 6) P89/541; 7) P90/1019; 8) P90/1073.

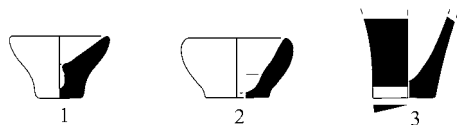

Fig. 20. Miniature conical cups: 1) P90/1519; 2) P89/413; 3) P90/1550.



Fig. 21. Miniature conical cups: 1) P90/1519; 2) P89/413; 3) P90/1550.

P89/515. Handleless conical cup. H. 3.7 cm, base d. 4.6 cm, rim d. 7.7 cm. Fine brown clay with few inclusions; self-slip.

P89/541. Handleless conical cup. H. 4 cm, base d. 3.4 cm, rim d. 8 cm. Fine buff clay with few inclusions; self-slip.

P90/846. Handleless conical cup. H. 4 cm, base d. 4.1 cm, rim d. 7.9 cm. Yellowish medium clay; self-slip.

P90/850. Handleless conical cup. H. 4 cm, base d. 4.1 cm, rim d. 8.3 cm. Yellowish medium clay; self-slip.

P90/1019. Handleless conical cup. H. 4.5 cm, base d. 4.3 cm, rim d. 8.1 cm. Light orange medium clay; self-slip.

P90/1026. Handleless conical cup. H. 4.4 cm, base d. 3.7

cm, rim d. 8 cm. Light orange medium clay with several inclusions; self-slip.

P90/1073. Handleless conical cup. H. 3.8 cm, base d. 3.8 cm, rim d. 8 cm. Buff medium clay with several inclusions; self-slip.

P90/1467. Handleless conical cup mended from five sherds. H. 4.1 cm, base d. 4.2 cm, rim d. 8.2 cm. Fine buff clay with various inclusions; self-slip.

9) The deposit in Room E also included a few miniature conical cups (Figs. 20–21), which are rarely found in other parts of the site. It is possible that they had a special function in measuring very small quantities of a specific substance.

P89/413. Miniature handleless conical cup. H. 2.8 cm, base d. 2.6 cm. Reddish medium clay, unevenly fired; self-slip; worn surface.

P90/1519. Miniature handleless conical cup. H. 2.6 cm, base d. 1.6 cm. Orange medium clay with few inclusions; self-slip.

P90/1550. Miniature handleless conical cup. Pres. h. 2.8 cm, base d. 2.4 cm. Fine buff clay; self-slip.



Fig. 22. Tripod tray P89/577.

The remaining fine pottery from Room E included a few uncommon shapes in limited numbers. Among these is a tripod tray (Fig. 22) made of fine to medium orange clay, with orange slip and decoration on both surfaces. The legs are not preserved. The decoration, consisting of bands and a cross inscribed in a circle on the interior of the



Fig. 23. Firebox P90/1505.

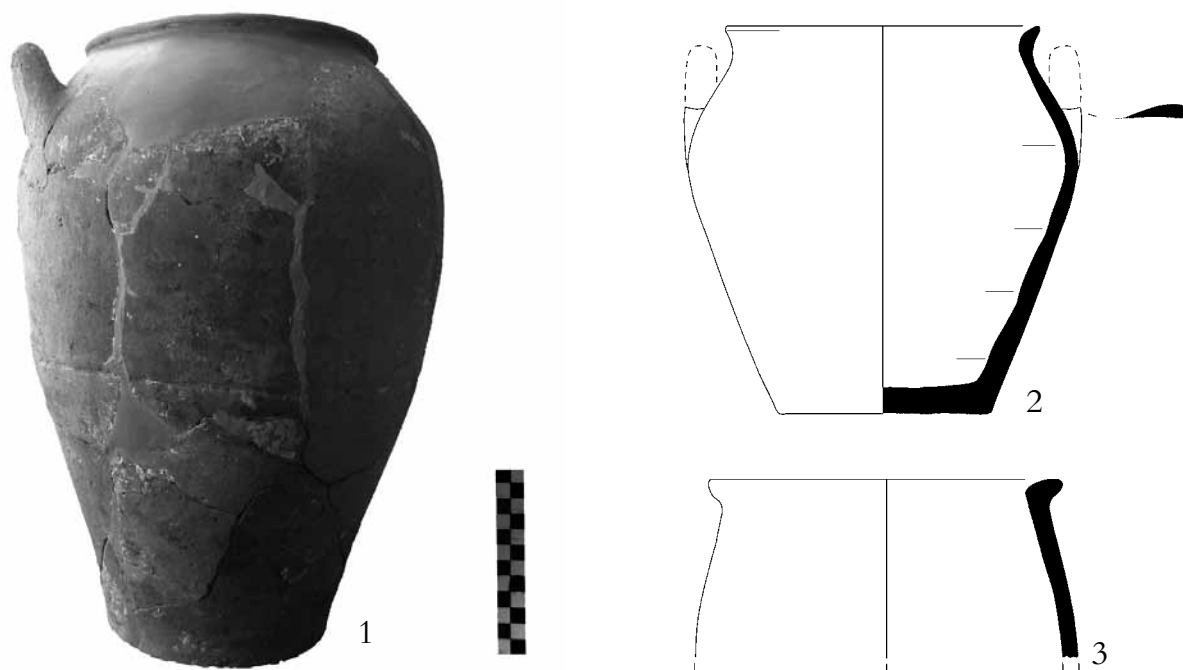

Fig. 24. Pithoid jars: 1) P90/817; 2) P90/1557; 3) P90/122/3.

base, is rather careless. An identical example with similar decoration was found at Mochlos.²⁶ The Petras vase, which was probably used for serving food, had fallen from the upper floor.

P89/577. Tripod tray mended from eight sherds. Pres. h. 3.6 cm, base d. 17.4 cm, rim d. 18.7 cm. Medium orange clay; orange slip; orange brown paint; uneven firing.

A firebox was probably associated with the industrial activities in the building (Fig. 23). It was made from a medium reddish clay very similar to that used for cooking pots.

P90/1505. Firebox. H. 6.2 cm, rim d. 8.6 cm. Reddish medium clay; self-slip (cf. Barnard & Brogan 2003, fig. 53, IB.616; Sackett & Popham 1970, fig. 17).

Room E also contained a limited number of pithoid jars (Fig. 24). One example, made with reddish me-

dium clay, had horizontal handles and an elongated oval body. At Petras this type of pithoid jar does not appear before LM IB and is absent from LM IA destruction deposits. Several fragmentary examples were found in the Palace and other rooms of House II.1. A second type of pithoid jar, also with horizontal handles, resembles examples from Palai-kastro.²⁷ This jar is smaller and has a wider base, an ovoid/piriform body, and a higher neck.

P90/122/3. Pithoid jar. Pres. h. 6.8 cm. Medium reddish-brown clay; self-slip.

P90/817. Pithoid jar. H. 39 cm, base d. 15 cm, rim d. 23 cm. Reddish medium clay with many inclusions; self-slip.

²⁶ Barnard & Brogan 2003, fig. 12, IB.265.

²⁷ Sackett & Popham 1970, fig. 17.

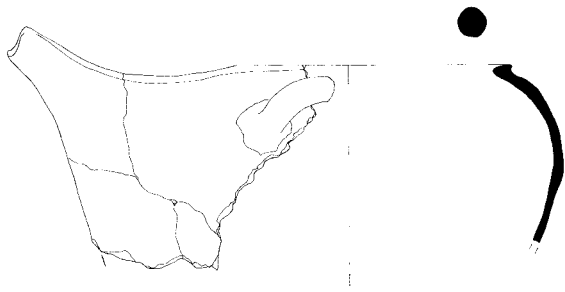

Fig. 25. Spouted basin P90/1497. Not to scale.

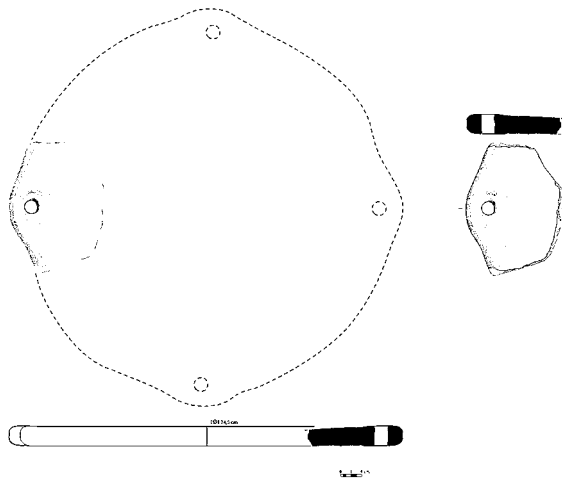

Fig. 26. Discoid large object (lid?) P90/1214. Not to scale.



Fig. 27. Incense burner P90/470 and strainer pyxis P90/333.

P90/1557. Pithoid jar. H. 24.8 cm, base d. 12 cm, rim d. 15.8 cm. Reddish medium clay; self-slip (for similar examples from Mochlos with vertical handles, see Barnard & Brogan 2003, fig. 41, IB.452; for Palaikastro, see Sackett & Popham 1970, fig. 17).

A spouted basin (Fig. 25), made of the same reddish medium clay, represents another shape that is confined to the LM IB levels at Petras. Parallels are found at Palaikastro and Mochlos.²⁸

P90/1497. Spouted basin. Pres. h. 6.8 cm. Reddish medium clay, red slip.

The house also contains a small fragment of a very large, flat, discoid object (Fig. 26) made of coarse red clay, and which has exact parallels from Zakros (on display in the Siteia Museum). The problem with interpreting these heavy, large circular objects as lids is that their diameter (more than 70 cm) is larger than any of the preserved pithoi, though they could have served as lids for containers made of perishable materials.

P90/1214. Discoid object (lid?). Max. pres. dim. 12 x 8.6 cm. Brown-reddish coarse clay; self-slip.

Finally, Room E contained several fragments of strainer pyxides, a special shape analyzed by Maria Andreadaki-Vlazaki,²⁹ and also fragments from incense burners, another shape associated with fire (Fig. 27).

P90/333. Strainer pyxis. Max. pres. dim. 7.8 x 9 cm. Brown medium clay; no slip is preserved (for parallels, see Barnard & Brogan 2003, fig. 28; Sackett & Popham 1970, fig. 15).

Decoration

The presentation of shapes from this LM IB deposit at Petras reveals that the number of decorated vessels is small, and the decoration itself includes a limited range of motifs. It is noteworthy that ripple pattern is completely absent from all LM IB deposits at Petras. A simple comparison of the pottery analyzed here with contemporary deposits from other areas (both those presented at the LM IB Confer-

²⁸ Sackett & Popham 1970, fig. 18; Barnard & Brogan 2003, fig. 10, IB.241.

²⁹ Andreadaki-Vlazaki 1987, 55–68.

ence in Athens and also in previous publications) shows very clearly that the LM IB pottery from Petras lacks diversity, despite its good general quality. It is also important to note that it does not include classic LM IB features such as the Marine Style and Alternating Style. These are not only absent from House II.1, but also from the LM IB deposits of the Palace. Thus, their absence is not due to the function of House II.1, which was transformed into an industrial installation in its final stage of occupation. Furthermore, there are no stirrup jars at Petras before LM III, and even then they are rare. These features distinguish Petras from neighboring sites like Mochlos, Zakros, Palaikastro and Pseira, though the reasons for this pattern are not clear. At Mochlos the Marine Style was found both in elite houses and in the Artisans' Quarter; however, it was also observed that pottery from the Artisans' Quarter did not exhibit the same variety of decorative techniques and arrangements as found in the main town.

At Petras all vessels, even those made in a medium or coarse fabric, are slipped; the coarser examples tend to have a thin slip, while the fine wares tend to have thicker ones. The slip is usually the same color as the clay or slightly lighter. The paint is typically matte, though often worn and rarely burnished, and reddish, reddish-brown, brown or black in color. Monochrome cups are usually dipped in paint, rather than painted all over. The same is true for cups decorated with a band on the rim, where there are usually dribbles of paint. Open as well as closed shapes are often decorated with bands, in combination with zones of linear motifs; these include stylized floral elements like foliate bands and running spirals. Light-on-dark painted pottery is absent from the deposits of Room E, with the exception of two fragmentary cups that have parallels at Mochlos. Added white paint on dark decoration, usually applied in thin bands over wider dark bands, is also rare at Petras in LM IB.

IV. The vessels in cooking fabrics from Room Epsilon of House II.1 (M.E. Alberti)³⁰

The vessels in cooking fabrics also form a major component of the LM IB ceramic assemblage from Room Epsilon of Petras House II.1. A general, systematic study of Minoan cooking ware is still lacking, and previous studies have tended to focus on the specific evidence from particular sites. These studies have identified the primary technical, typological and functional characteristics of Minoan cooking wares and have highlighted the major chronological developments and distribution patterns on Crete. The most important quality of cooking vessels, however, is their resistance to thermal shock.³¹ These pots also typically have rounded profiles with thin walls and are made from non-calcareous fabrics fired at a low temperature – all means of improving heat resistance.

Minoan cooking fabrics are highly consistent. From EM to the end of LM III, the cooking fabrics from different parts of Crete share the same

³⁰ I present here the first results of my study of the cooking wares from House II. This work was conducted as part of my PhD research (2001–2005 at the University of Udine, Italy) and as the subject of a post-doctoral scholarship of the Italian School of Archaeology at Athens (2005). My warmest thanks are due to S. Apostolou and Dr. M. Tsipopoulou for entrusting me with the study of the material and to Prof. E. Borgna and Prof. P. Càssola Guida (University of Udine) for their continuous help and support during my PhD studies. I also would like to thank Prof. E. Greco and all the staff of the Italian School, who facilitated my stay and research in Greece. My work on the Petras material would not have been possible without the help of G. Costopoulou and C. Zervaki, as well as the assistance of the staff of the Archaeological Museums of Siteia and Hagios Nikolaos.

³¹ “Diversamente le ceramiche da fuoco non devono temere sbalzi termici cosicché l'impasto sarà magro, ricco di sabbia e ossidi di ferro e povero di fondanti quali appunto il calcare. La bassa espansione termica è così ottenibile a discapito della coesione spesso scarsa, delle forme necessariamente semplici, del colore scuro. Essa è anche accresciuta da pareti sottili, assenza di spigoli e carene, porosità elevata.” (Mannoni & Giannichedda 1996, 159); Riley 1983, 290; Moody 1985, 53–4; Rice 1987, 228–31, 236–8, 366–9.

basic features: they are non-calcareous and contain primarily phyllite and mica inclusions. Firing temperatures are generally low (i.e., not more than 750°C), thus improving the way cooking pots resist thermal and dynamic shocks.³² These fabrics were used for a wide range of shapes, not all of which were connected to cooking activities. “While cooking may have been the main use of the Coarse Red pottery, the shapes are suitable for other functions as well. Probably the same shapes were used for dyeing cloth, making perfume, warming milk to make cheese, and many other purposes. In addition to food preparation, the vases discussed here were surely used for many different processes.”³³

Scholars have approached this class of pottery in different ways. In the recent publication of the ceramics from the Mochlos Artisans’ Quarter, the authors separated the “vessels in cooking fabric” as a specific group.³⁴ It is generally very difficult to determine the function of pots based on their shape alone, and their suggested functions are not always confirmed by the context of the vessels.³⁵ The range of Minoan vessels in cooking fabric includes tripod cooking pots, cooking jars (i.e., cooking pots without legs), cooking trays, trapezes (see below), cooking dishes, spit-rests, fire-stands/ovens, braziers/scuttles, incense-burners and lamps.³⁶ The first typology of cooking shapes was made by Betancourt for the pottery from Kommos, and it was followed by Martlew’s more synthetic overview.³⁷ Further insights into Minoan (and Mycenaean) cooking, and an outline of recurring shapes from different sites and periods, are provided in the volume *Flavours of our Time*.³⁸ Finally, several recent publications of cooking wares provide local perspectives from various sites on Crete.³⁹

General remarks

As stated above, vessels in cooking fabric form a conspicuous component of the finds from Room Epsilon. They include at least 58 fragmentary cooking pots of various shapes, 21 fragments of cooking dishes, and 1 spit-rest. No cooking trays or trapezes are attested from this room, though these shapes are documented in other parts of the house. Other, less

diagnostic cooking ware fragments can be added to this list, including 15 handles, 27 base sherds, 32

³² Phyllite and mica tempered fabrics are common both in eastern and southern Crete: Whitelaw *et al.* 1997, 270 (Myrtos Phournou Koriphi); Day 1997 and Day, Wilson & Kiriatzi 1997, 281 (south coast and the Gulf of Mirabello); Myer & Betancourt 1990 (Kommos); Haggis & Mook 1993 (Kavousi and the Gulf of Mirabello); Palio 2001a, 365 (Phaistos); Barnard 2003 and Day, Joyner & Relaki 2003 (Mochlos and comparisons with Pseira). Day 1997, 227, n. 43: “Phyllite inclusions are plate in their nature and therefore are likely to be aligned parallel to the pot wall, transmitting stresses around the vessel instead of across the pot wall. This may avoid cracking when the pot expands through heating.”

³³ Betancourt 1980, 7.

³⁴ Barnard & Brogan 2003, 80–9. See also the “Coarse Red” label used by Betancourt for Kommos (Betancourt 1980). In the same way, we could also use the translation of the Italian expression “ceramica da fuoco” (“fire wares”), since most of these shapes are probably used in connection with fire or charcoal.

³⁵ For Akrotiri, “...the attempt to assign some kind of function to pottery based on palaeobotanical material in the West House has so far been unsuccessful. In fact, our results indicate instead that each pottery type had multiple functions; and, interestingly, pots whose shape imply a liquid content, such as ewers, amphorae, and kraters, were used for storing dry plant materials as well. An already published example is the jar (ewer) found sealed in Δ 16 by Professor Marinatos, which contained a legume, whereas the shape of the vessel indicated liquid storage. Thus any hypotheses about the content of pots based on shape alone are, at least at present, still unsubstantiated” (Sarpaki 1992, 229).

³⁶ See the typology in Hallager 1997b, 417. Other shapes (large tripod basins, tripod cooking bowls and cooking tables/stands) have been listed among the Protopalatial cooking wares from Knossos (Macdonald & Knappett 2007, 77 nos. 253–6, fig. 13.13, pl. 22; 105 nos. 528–32, fig. 3.32, pl. 33–4); however, small tripod basins and tripod cooking bowls can be considered, as well as Type B cooking pots and pans. Many lamps and braziers are made in cooking fabric, but should not be considered among cooking wares *strictu sensu*: Georgiou 1983, 75. See also Floyd 1999 and Rice 1987, 210–42, esp. 224–5, 236–42, and figs. 7.1, 7.4, tbl. 7.2.

³⁷ Betancourt 1980; Martlew 1988.

³⁸ Martlew & Tzedakis 1999. The relationships between food, drink and society in prehistoric Greece are also explored in Halstead & Barrett (2004).

³⁹ Kastelli Khania (LM III: Hallager 1997b; Hallager & Hallager 2000; 2003), Phaistos (LM III: Borgna 1997 and 2000), Kommos (MM II-LM III: Rutter 2004; Rutter & Van de Moortel 2006); Malia (MM II: Poursat & Knappett 2005); Mochlos (LM IB: Barnard & Brogan 2003), Palaikastro (MM IIIB – LM IA: Knappett & Cunningham 2003).

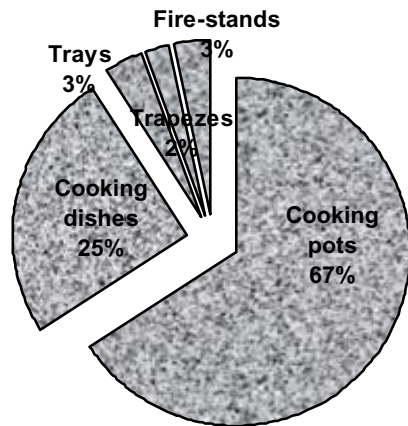

Fig. 28. Vessels in cooking fabric from House II: the main shapes.

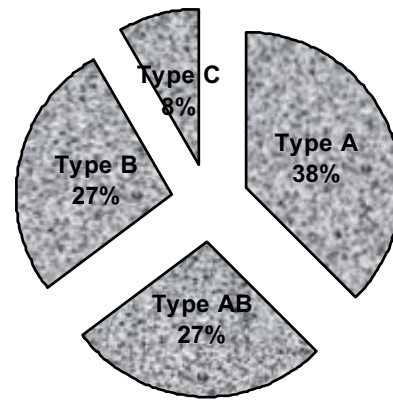

Fig. 29. Different types of cooking pots from House II.

legs, and a number of body sherds.⁴⁰ To complete the picture, I would also like to draw attention to the other coarse ware vessels, such as kalathoi and small jugs, which were discussed earlier in this paper. As the study of the remaining rooms in the building has not yet been completed, the overall picture for the house remains incomplete.

A concentration of vessels in cooking fabric comes from the northeast corner of the room, where three cooking pots, five kalathoi, a foot from a tripod cooking vessel, one small, spouted cooking pot, and three coarse ware sherds were found. The majority of the cooking ware belongs to Level 1 (i.e., the collapse of the upper floor),⁴¹ while other clusters come from the collapse above the ground floor (Level 2) and from the floor itself (Level 3).⁴² This evidence suggests that cooking ware was being stored upstairs. My study of the assemblage also paid close attention to vessel size, as this information can provide insights into the actual use of the vases. The assemblage contained a large number of medium-sized vessels. Larger vessels were present, but represent only 1/6 or 1/10 of the total inventory. A limited number of smaller vessels were also attested. It therefore appears that the operations carried out in Room Epsilon (or nearby) were primarily of medium-scale, though the presence of two large cooking pots and a huge cooking dish suggest occasional periods of more intense cooking.

Pots are the most common cooking shape in the assemblage, with 58 fragments. Cooking dishes

comprise the second largest group, with 21 fragments. Other shapes are present in smaller numbers (Fig. 28). Among cooking pots, there are only four fragments of the hole-mouthed variety (C), while the other types: globular (A), elongated (AB) and straight-sided (B) occur in more or less equal numbers – 18, 13 and 13 respectively (Fig. 29).

The value of petrographic analysis for the final interpretation of the cooking wares is clear; unfortunately, no systematic study has yet been undertaken for House II.1. The macroscopic analysis of the House II.1 cooking wares suggests that they fit the typical pattern for East Crete, exhibiting a preference for phyllite fabrics.⁴³

⁴⁰ A proper attempt to identify cooking sets (see Rutter 2004, 80) will be made for the final publication of the material. Because the majority of the assemblage consists of diagnostic sherds with few whole or restorable vases, it was not possible to use the ratio between body size and leg size as a parameter in the classification, as suggested by Dr. E. Banou in the response to this paper.

⁴¹ Ομάδα 90/103 and 90/115.

⁴² Level 2: ομάδα 89/244; Level 3: ομάδα 89/227.

⁴³ The cooking fabrics from House II contain phyllites, quartz, calcite, and mica. Thanks to recent studies, it is now clear that coarse wares can serve as chronological markers (e.g., Moody 1985 for the Khania region; Haggis & Mook 1993 for Kavousi and the Northeast Mirabello region; and Martlew 1996, 144). Fabric analysis studies have demonstrated that coarse wares were exchanged over long distances (Riley 1983; Day 1988; Day, Wilson & Kiriati 1997; Knappett 1997; 2000; Whitelaw *et al.* 1997).

Typological classification

A) Tripod cooking pots

The vast majority of preserved cooking pots from Room Epsilon are of the tripod variety. Only one certain example of a cooking jar without legs is attested.

These vessels were clearly associated with cooking activities, especially boiling and stewing.⁴⁴ At the same time, they could have been successfully used in other production processes (e.g., washing textile fibers in hot water, making dye-baths and for storage). It also appears that cookpots were re-used as portable braziers once they were no longer suitable for cooking food.⁴⁵

The shape of the Petras tripod cooking pot can vary considerably.⁴⁶ The body can have a globular or conical profile, a flat base, an everted or plain rim, and an open mouth, typically with a spout. The shoulder carries two horizontal, or occasionally vertical, handles that are round to slightly ovoid in section, and less often a third vertical handle is placed opposite the spout. The exterior is generally water-wiped, producing a smooth, hardened surface. Some examples are self-slipped, though not on the bottom, which is always left rough. The interior is generally self-slipped, though it can also be simply water-wiped.

The dimensions of the House II.1 cooking pots vary, though they exhibit a range similar to examples from the Artisans' Quarter at Mochlos. The estimated average height is between 25 and 35 cm; the rim diameters range from 15 to 26 cm, and base diameters from 12 to 18 cm. The legs vary from 6 to 13 cm in length (average 7–9 cm), with maximum widths of 4 to 6 cm. The thickness of the vessels also varies, but the walls are usually not very thick, generally ranging from 0.5 to 1.5 cm. The rims are even thinner, ranging from 0.3 to 0.7 cm. Thin walls are to be expected in cooking wares because they conduct heat and resist thermal shock.⁴⁷ The vessels are all wheel-made with the exception of the legs.

Given the high variability of the shape, a strict typology is not possible. Previous studies have not-

ed a broad distinction between pots with a narrow mouth and globular profile (Betancourt Type A) and pots with a wide mouth and conical or straighter profile (Betancourt Type B).⁴⁸ This differentiation is generally thought to be linked to chronological factors: Type B is more common in MM and MM III/LM IA (e.g., Knossos, Kommos and Mochlos), while Type A appears mainly from LM IB onwards (e.g., Malia, Pseira, Mochlos, Palaikastro, Zou, and Chalara Phaistos). At Mochlos "it seems clear that Type A pots basically replace those of Type B profile around the end of LM IA or during LM IB."⁴⁹ Some regional variations can also be detected, however. With few exceptions, LM IB Type A pots appear to be an East Cretan phenomenon. Type B cooking pots, on the other hand, continue to be used exclusively in Central and West Crete during LM IB, while also occurring in much smaller numbers in the East.⁵⁰

⁴⁴ For a discussion of various types of pots (Minoan, Mycenaean or of Mycenaean derivation) and their connection with different ways of cooking, see Borgna 1997, 200–5 and 2000, 148–50. For the links between types of cooking pots, see Martlew 1996, 145 and Filippa-Touchais 2000, 426.

⁴⁵ Filippa-Touchais 2000, 423–4. Minoan tripod cooking pots resemble *μαργάλλια*, the traditional portable braziers of modern Crete (Blitzer 1984, 149–50, fig. 18:5.8).

⁴⁶ For a general description of the shape, see Barnard & Brogan 2003, 81. The typological transformations observed in later times (LM II–III) are not considered here.

⁴⁷ Barnard & Brogan 2003, 81. At Kastelli Khania, rim diameters of LM IIIB2/C pots range from 13 to 34 cm (Hallager & Hallager 2000, 158).

⁴⁸ Betancourt 1980.

⁴⁹ Barnard & Brogan 2003, 81.

⁵⁰ Type A is the most common LM IB type in East Crete, though this conference has revealed the presence of LM IB pots of this type at a much wider range of sites than previously known. It is interesting that globular profiles (even of different types) already appear in MM II cooking wares at Malia (Poursat & Knappett 2005, 56–7, nos. 341–4 and 360–1, figs. 3, 12, pls. 17, 47). Type B examples are known from EM IIB Myrtos Phournou Koriphi (Warren 1972, fig. 62), MM IIB Apodoulou (Tzedakis & Martlew 1999, 88, 91, 183, nos. 53, 61–2, 173), MM IB–IIA Knossos (Macdonald & Knappett 2007, nos. 253–5, 528–32; see n. 6) and MM II Malia (Poursat & Knappett 2005, 56, nos. 346–9, fig. 12, pls. 16–7). In MM III/LM IA, the shape is attested mainly at Knossos, Phaistos, and Kommos, but also at Malia (see n. 34) and Mochlos (Barnard & Brogan 2003, 81). In LM IB, it is present at least at Khania, Chalara, Malia and Mochlos (see n. 30). At

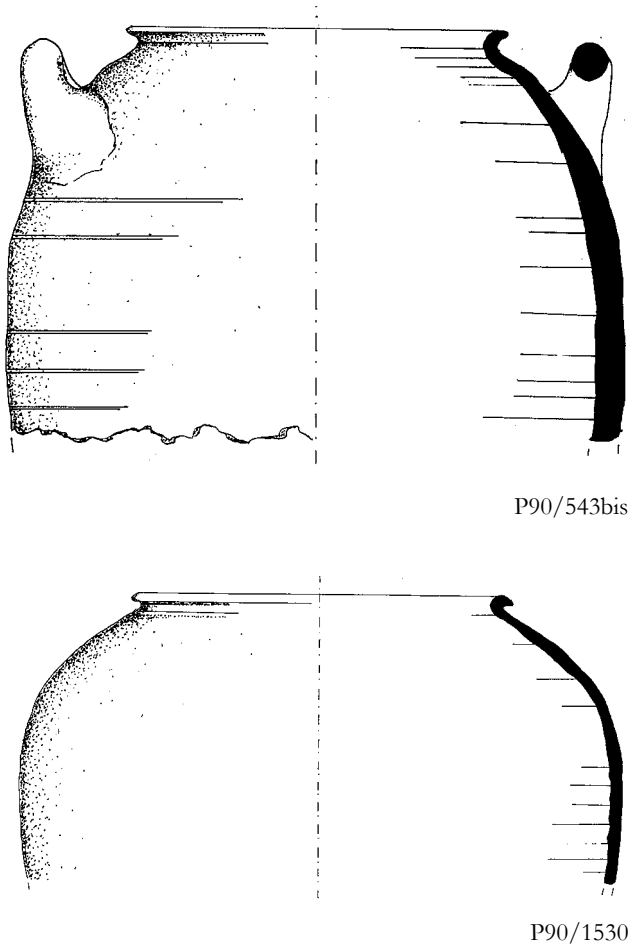

Fig. 30. Tripod cooking pots with globular profile (Betancourt Type A): more globular profile and more everted rim. (Scale 1:4).

A.1) Tripod cooking pots – globular profile (Betancourt Type A)⁵¹

This type of cooking pot has a narrow mouth, globular body profile, everted rim, two horizontal handles on the shoulder, a flat base standing on three legs, and frequently a small spout. The globular cooking pots are also generally taller than their maximum diameter.⁵² Theoretically, they are best suited for slow cooking or slow firing processes: soups and stews or long dye-baths. Steam and heat are retained longer by the narrow mouth and better distributed by the rounded body.⁵³ This type is largely attested in LM IB contexts, especially in East Crete.⁵⁴

A.1)a Tripod cooking pots

Thirteen globular cooking pots are recorded from House II.1: ten from Room Epsilon and three from other parts of the building.⁵⁵ They are all very simi-

Kommos, Type B pots continue from LM IA to LM III (see n. 20 and 30); however, while they are common throughout LM I-II (when Type A pots are scarcely attested), they are outnumbered by globular pots of Mycenaean type in LM III (Betancourt 1980, 3, 5 and 9). At Kommos there are also large numbers of cooking jars (Rutter 2004, fig. 4.5). At LM IB Chalara, the majority of cooking pots are Type B (Palio 2001a, nos. 281, 282, 327, 376, 461, 462, 651, 675, 926, figs. 46h, 41 and 51o), though other types are also attested (Palio 2001a, no. 653, fig. 41, probably Type AB; no. 359, and 621, not illustrated, probably Type A; nos. 22 and 714, not illustrated, probably Type C). The LM IB Type B examples shown during the conference are mainly from West and Central Crete, though also from eastern sites. There are only a few examples known from LM IIIC (Borgna 2000, 148), when the general shape of cooking pots becomes more globular (with rounded bottoms), perhaps under the influence of Mycenaean prototypes. This development should not be confused with the LM IB “Minoan” Type A pots (with flat bases). Quite interestingly, MM II cooking wares at Malia already show a complex pattern where all of the main features (globular or straight profile, tripod legs or no legs, and large, medium and small sizes) coexist and are variously combined (Poursat & Knappett 2005, 56–8).

⁵¹ Betancourt 1980, 3, figs. 1A and 5A; Martlew 1988, 422, BI.

⁵² During LM IIIB and LM IIIC, these pots develop into a type closer to Mycenaean examples and contemporary cooking jars, with rounded body, strongly everted rim and a rim diameter that almost equals the height. See LM III Kommos (Betancourt 1980, 2, C45 and C646, fig. 1; Rutter 2004, fig. 4.13, C11833, and fig. 4.15, C2497; Rutter & Van de Moortel 2006, no. 56e/8, pl. 3.60, no. 59/16, pl. 3.68, no. 67a/23 and 67a/24, pl. 3.78), LM IIIB2 Kastelli Khandia (Hallager & Hallager 2000, 87, pl. 45, 73c) and LM IIIC Phaistos (Borgna 1997, fig. 3.1c). See also Tzedakis & Martlew 1999, 112–35 for “Mycenaeanizing” and Mycenaean examples.

⁵³ Borgna 2000, 148.

⁵⁴ Some LM IB examples include Mochlos Artisans’ Quarter Building A: IB.490; IB.492; IB.495; IB.496; IB.501; Building B: IB.491; IB.493; IB.494; IB.497; IB.498 (Barnard & Brogan 2003, 81–2, figs. 47–8, pl. 25); Mochlos Chalinomouri: IB.499; IB.500; IB.502 (Barnard & Brogan 2003, 81–2, figs. 48–9); Palaikastro, Block N: NP111, NP113 (Sackett, Popham & Warren 1965, 264; Sackett & Popham 1970, 227–8, figs. 17–8, pl. 64d); Chalara Phaistos: nos. 621, 653 (Palio 2001a, 324, 326, figs. 41, 53g); and Pseira Plateia Building: BS/BV91 (Floyd 1998, fig. 6).

⁵⁵ ME and loci: P90/169 (Room Epsilon, 3A locus 1); P89/1020 (Room Epsilon, NW corner); P90/1530,

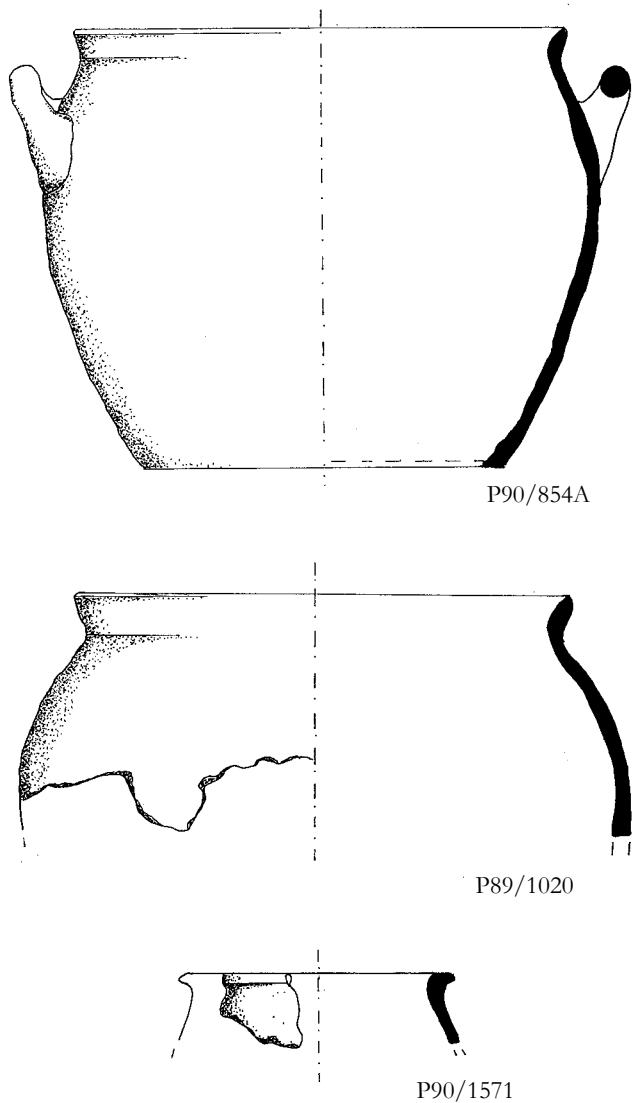

Fig. 31. Tripod cooking pots with globular profile (Betancourt Type A): globular profile and large, almost flaring rim. (Scale 1:4).

lar and medium-sized; no large example is attested. However, some distinctions can be made. P90/543 bis and P90/1530 have a more globular profile and a more everted rim (Fig. 30). P89/1020, P90/854A and P90/1571 have a globular profile and a large, almost flaring rim (Fig. 31). P90/169 and P90/1577 have a less globular, piriform profile and an everted rim with a spout (Fig. 32). P90/1252A and P90/854B have a less globular profile and a short, almost flaring rim (Fig. 33). Other medium-sized examples include P89/242/1, P90/103/19, P90/1371A, and P90/366/2.

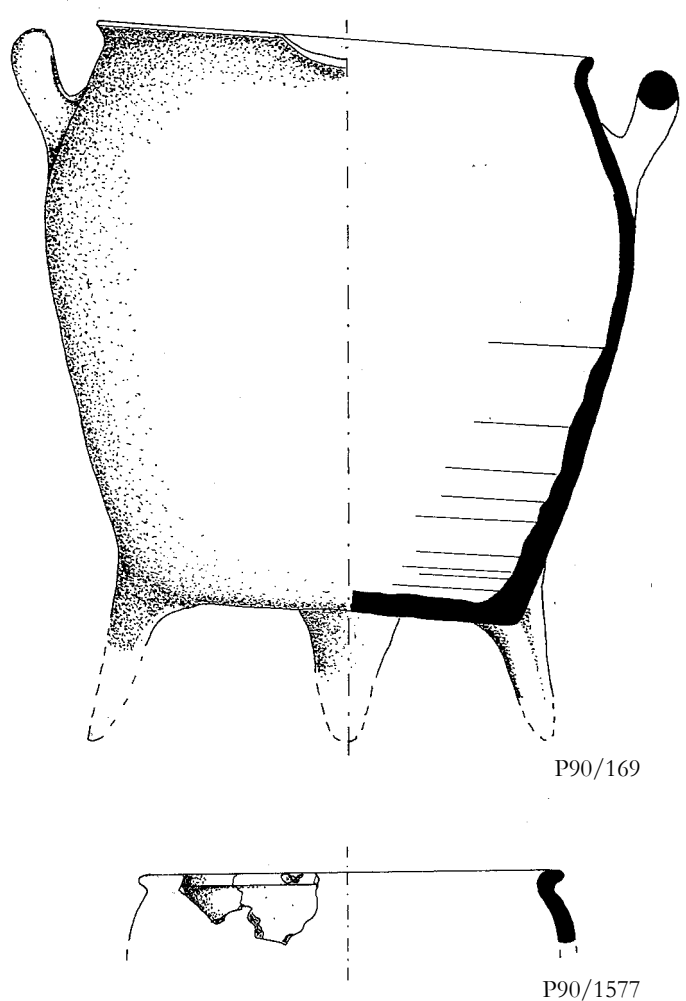

Fig. 32. Tripod cooking pots with globular profile (Betancourt Type A): less globular, piriform profile and everted rim with spout. (Scale 1:4).

A.1)b Flat-based cooking pots

Most of the cooking pots from House II.1 are fragmentary, so it is not possible to determine whether or not they were built with tripod legs. Only one example was definitely made without legs: P90/889. It has a small, globular body, large flaring rim, and vertical handle (Fig. 34).⁵⁶

P89/1020, P90/1571, P90/1577, P90/1252A, P89/242/1, P90/103/19, P90/1371A and P90/366/2 (all from Room Epsilon); P90/543 bis (Room Theta); P90/854A and P90/854B, BII3B1 (N wall).

⁵⁶ ME and loci: P90/889 (Room Epsilon, locus 1). See MM IIIB Palaikastro (Knappett & Cunningham 2003, 158, no. 308, fig. 38, EP 87).

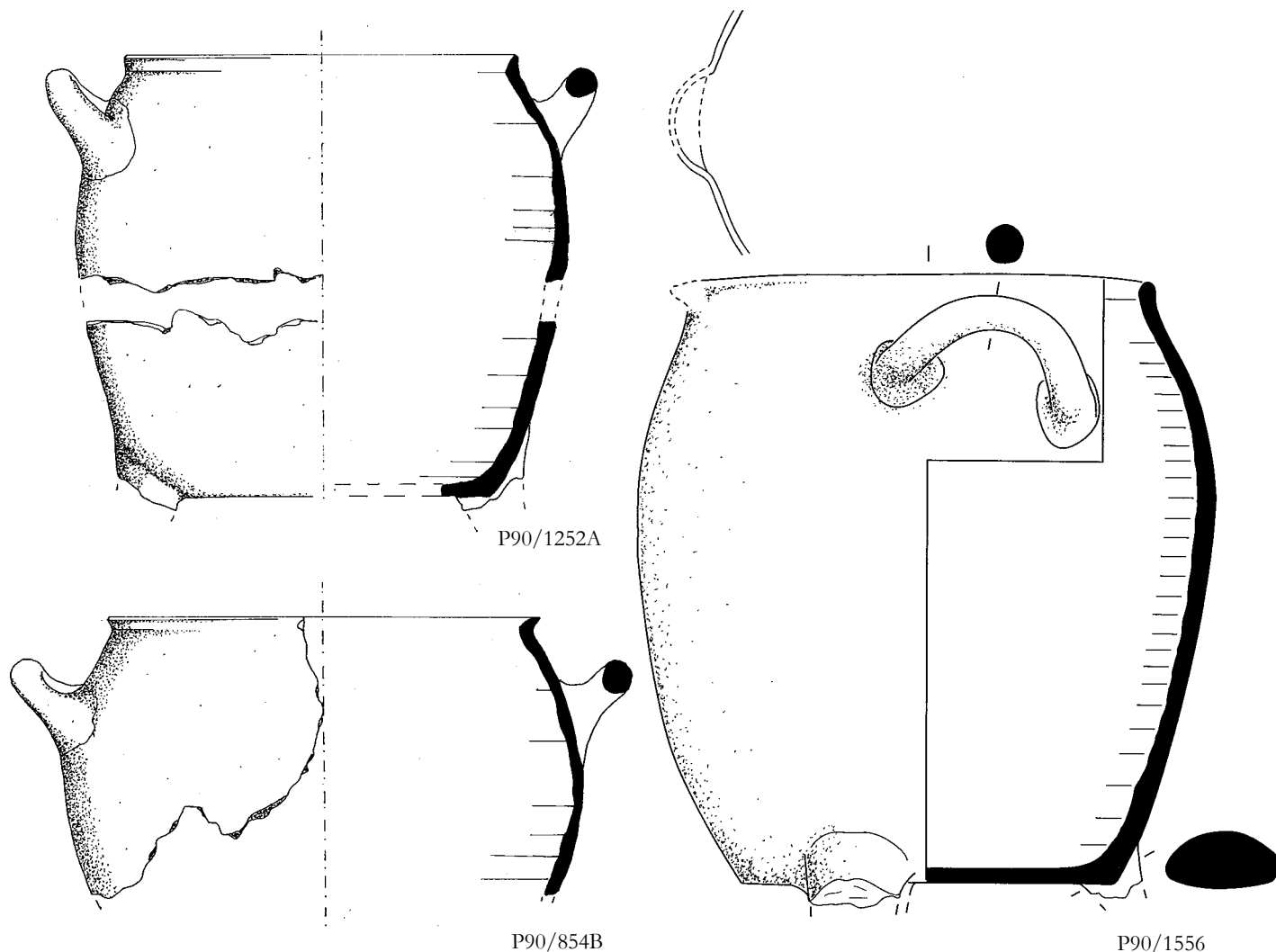

Fig. 33. Tripod cooking pots with globular profile (Betancourt Type A): less globular profile and short, almost flaring rim. (Scale 1:4).

Fig. 35. Tripod cooking pots with elongated profile (Type AB?): large-sized examples. (Scale 1:4).

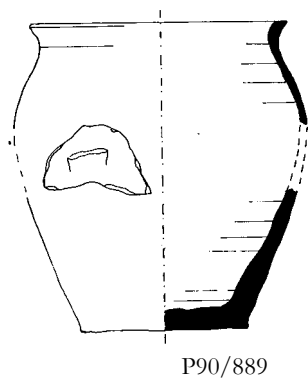

Fig. 34. Cooking pots with globular profile and flat base. (Scale 1:4).

A.2) Tripod cooking pots – elongated profile (Type AB?)

One group of tripod cooking pots from House II.1 has an intermediate profile between Betancourt Types A and B, and can therefore be called Type AB. This vessel type has a narrow mouth, elongated and curved body, smoothed, almost non-existent shoulder, and plain rim. The base is flat as usual, and in one case there is a spout.

P90/1556 (h. 35 cm) is a large, spouted version from Room Epsilon (Fig. 35). The eleven other examples are medium-sized, including a complete pot from Room Epsilon (P90/429), which is closer in shape to the globular Type A version. One vessel

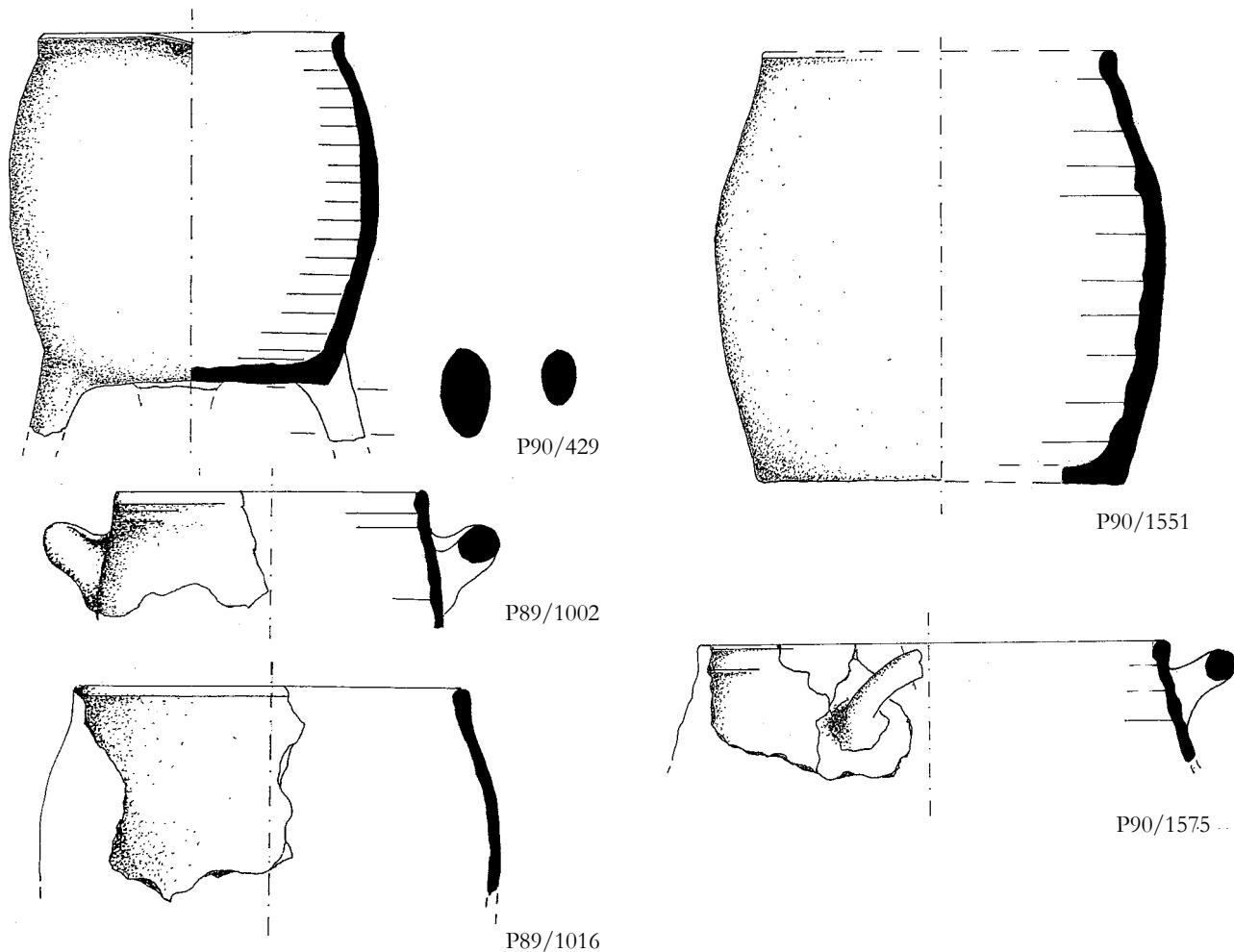

Fig. 36. Tripod cooking pots with elongated profile (Type AB?): medium-sized examples. (Scale 1:4).

has a complete profile (P90/1551), while the others are fragmentary (P89/1002–P89/1019 [spouted], P89/1016, P90/131/2, P90/1553, P90/1575, P90/252/1, P90/251/2, P90/252/1) (Fig. 36). Finally, one medium-sized version (P90/823) was found in Room Kappa.⁵⁷

This type of elongated profile has not yet been distinguished in publications, though comparisons can be found at Kommos and Mochlos, among the Type B examples, as well as at Malia.⁵⁸ If there really is a transformation (at least in East Crete) in cooking pot types from LM IA to LM IB, this intermediate form could represent part of the transition.

A.3) Tripod cooking pots – cylindrical profile (Betancourt Type B)⁵⁹

The primary characteristic of this type of cooking pot is the large mouth, which gives the body a more

cylindrical profile; this type also has a short, thick and occasionally flaring rim, and is often given a small spout. Two horizontal handles are placed on the shoulder, while in some cases a vertical handle

⁵⁷ ME and loci: P89/1002–1019 (Room Epsilon, locus 1); P89/1016 (Room Epsilon, locus 2); P90/429 (Room Epsilon, II 3 A); P90/823 (Room Kappa); P90/1551 (Room Epsilon, locus 1); P90/1553 (Room Epsilon); P90/1556 (Room Epsilon); P90/1575 (Room Epsilon, locus 3); P90/131/2 (Room Epsilon, locus 2); P90/251/2 (Room Epsilon); P90/252/1 and P90/252/1 (Room Epsilon, locus 2).

⁵⁸ Kommos: C929 (Betancourt 1980, fig. 1, Type B, LM I); Mochlos Chalinomouri, IB.504 (Barnard & Brogan 2003, fig. 49, Type B); Malia Quartier Δ, a large example similar to P90/1556 (Demargne & Gallet de Santerre 1953, pl. XXXI, fig. 5, MM III-LM I); Malia Maison Zα, a small example (Demargne & Gallet de Santerre 1953, pl. XLI, fig. 3, no. 2).

⁵⁹ Betancourt 1980, 3, figs. 1B, 5B; Martlew 1988, 422–4, AII, DI and DII.

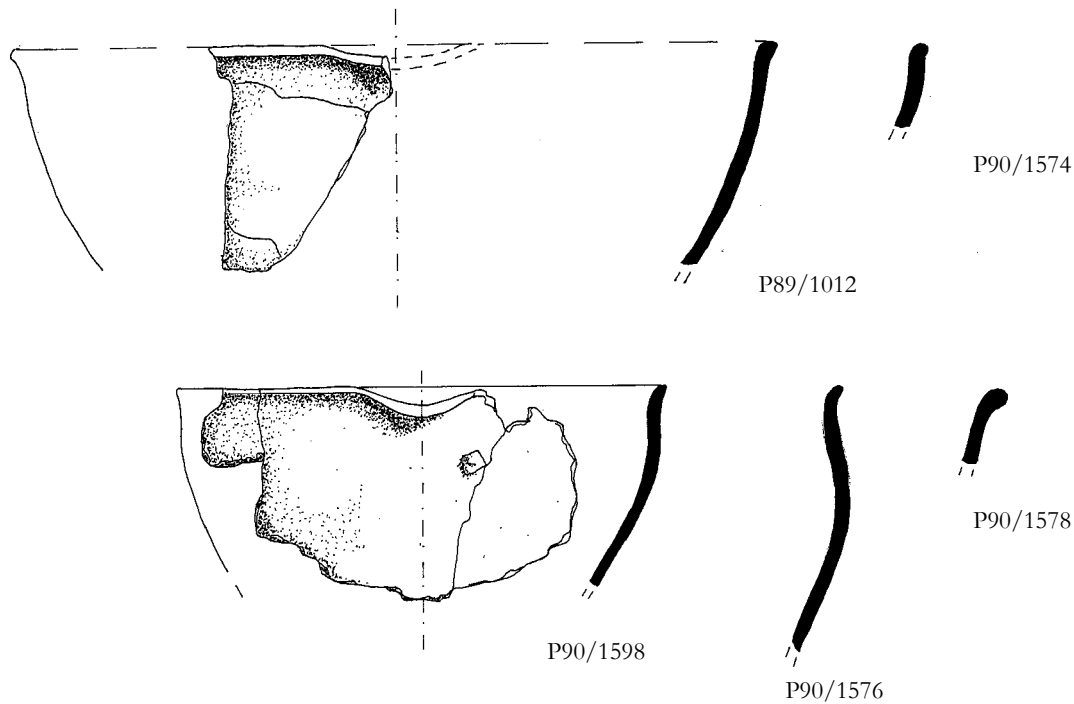

Fig. 37. Tripod cooking pots with curving, cylindrical profile (Betancourt Type B). (Scale 1:4).

or lug is found opposite the spout. The base is flat, and in eastern Crete, rope decoration is frequently applied near the base between the two front legs.⁶⁰ The straight profile and large mouth are more suitable for fast heating and boiling.⁶¹ Although more popular in the MM III/LM IA period, the shape is also attested during LM IB at Pseira, Mochlos, Makrygialos and Chalara.⁶²

The actual shape of the cooking pots varies considerably, but an important distinction can be made on the basis of size and general outline (i.e., taller vessels should be called pots, while shallower vessels should be called pans). This division also provides insight into the function of the vessels, a topic frequently overlooked in publications. In some cases, the pans have also been called “cooking jugs”, a term that is not well suited to the shape.⁶³

A.3)a Pots

These vessels have low walls and wide bodies with rim diameters reaching 30 cm. Generally, they are provided with two horizontal handles and a spout. In House II.1, they tend to have a very open body and large mouth, similar to large bowls or small basins. They also have either a slightly curving or flaring profile.

Curving profile – Two large (P89/1012, P90/1574) and three medium-sized examples (P90/1576, P90/1578, P90/1598) are attested (Fig. 37).

⁶⁰ Davaras 1997, 132, figs. 35–6 (Makrygialos, LM IB). There are also examples from Petras and Kato Zakros on display at the Archaeological Museum of Siteia.

⁶¹ Borgna 2000, 149.

⁶² MM IIIB Palaikastro (Knappett & Cunningham 2003, 156–7, nos. 293–4, figs. 36–7, B6R1/R3); LM IB Khania Daskaloyianni Street excavations (Tzedakis & Martlew 1999, 108–9, nos. 77–9); LM IA and LM IB Kommos (Rutter & Van de Moortel 2006, nos. 9b/9–10, pls. 33.30–1 (LM IA Early), nos. 22b/3 and 24/25, pls. 3.35 and 3.37 (LM IA Final), no. 37e/15, pl. 3.43 (LM IA Advanced – LM IB Early), 40/32 and 40/33, pl. 34.5 (LM IB Early); see also Rutter 2004); LM IA Seli Kamilari Phaistos (La Rosa & Cucuzza 2001, XXVII–19, 108, fig. 132); LM IB Chalara Phaistos (Palio 2001a, 301, 326 and 328 nos. 281, 282, 651, 675, figs. 41, 46h–i); LM IB Malia (Pelon 1966, 573, fig. 16); LM IB Pseira Plateia Building (Floyd 1998, fig. 3, BS/BV35) and LM I Building BY (Betancourt & Davaras 1999, fig. 44, BY35); LM IB Mochlos Artisans’ Quarter IB.505 and Chalinomouri IB.503 (Barnard & Brogan 2003, 81–2, fig. 49); Makrygialos (Davaras 1997, 132, figs. 35–6).

⁶³ In most publications, pots and pans are grouped together as Type B pots. They are, however, very different in terms of shape and function. See also the response to this paper by E. Banou.

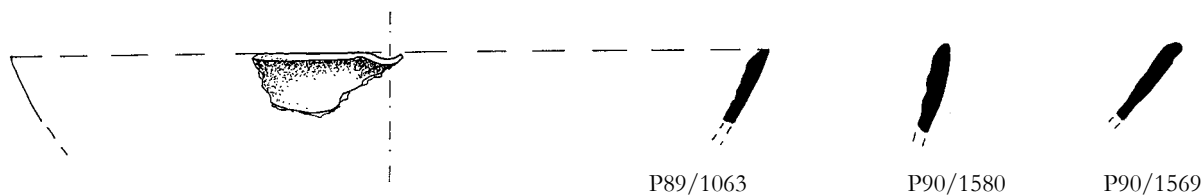

Fig. 38. Tripod cooking pots with a flaring, cylindrical profile (Betancourt Type B). (Scale 1:4).

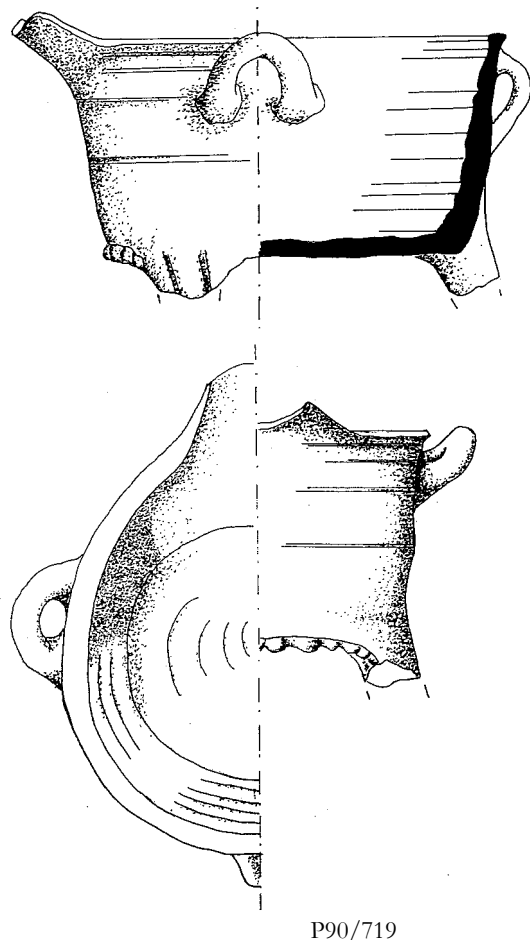

Fig. 39. Tripod cooking pan with cylindrical profile (Betancourt Type B). (Scale 1:4).

Flaring profile – Two large (P90/1580 and P89/1063) and one medium-sized examples (P90/1569) have been identified (Fig. 38).⁶⁴

A.3)b Pans⁶⁵

The pans are provided with lower walls, and they are distinguished by the presence of a spout on one side with a single vertical handle opposite. Their

dimensions are extremely variable, but most are medium-sized, with the exception of a few smaller examples.

Medium-sized – Medium-sized pans have rim diameters of ca. 18 cm, base diameters of ca. 10 cm and heights of ca. 20 cm. The legs are typically slightly pulled back from the front, and the shape occurs in both earlier and later contexts.⁶⁶

One of the best examples from House II.1 is P90/719.⁶⁷ This vessel has a conical profile with flaring walls, plain rim, two horizontal handles, and a small vertical handle opposite the spout. Rope decoration was added along the base, and wheel marks are visible on the exterior body, as well as vertical strokes on the legs (Fig. 39).

Small-sized – One small example is attested from House II.1 (P90/1570). Parallels have been found

⁶⁴ Another medium-sized pot can be added to the list (P90/103/sn18). ME and loci: P89/1012 E (sector west of locus 2); P89/1063 (Room Epsilon, locus 1); P90/1569 (Room Epsilon, locus 2); P90/1574 (Room Epsilon?); P90/1576 (Room Epsilon, II2, cleaning of north wall); P90/1578 (Room Epsilon, locus 2); P90/1580, P90/1598 and P90/103/18 (Room Epsilon, locus 1).

⁶⁵ Betancourt 1980, 2, fig. 1B, C103 (Kommos); Levi 1988, pl. 15n (Phaistos); Martlew 1988, 424, D II.

⁶⁶ Malia: MM II and MM III-LM IA examples in different sizes and profiles (Poursat & Knappett 2005, 57–8, nos. 362, 364–7, fig. 12, pls. 17 and 47 (MM II) and Demargne & Gallet de Santerre 1953, pl. XL, fig. 2, nos. 4–5, and pl. XLI, fig. 3, no. 1 (MM III-LM IA); Palaikastro: both large and medium-sized examples of MM IIIB (Knappett & Cunningham 2003, 136–7, nos. 181–3, figs. 21–2, B6R1/R3 and 156, no. 292, fig. 36, EP87) and LM IA (Knappett & Cunningham 2003, 170, no. 436, fig. 46, EP87); Chalara Phaistos: LM IB (Palio 2001a, 301, no. 281, fig. 46h); and Knossos Unexplored Mansion with a small example with two lugs from LM II (Popham 1984, 36 and 50, L110, pl. 86h, 162.11).

⁶⁷ ME and loci: P90/719 (Room Epsilon, West from II 3 A [α]).

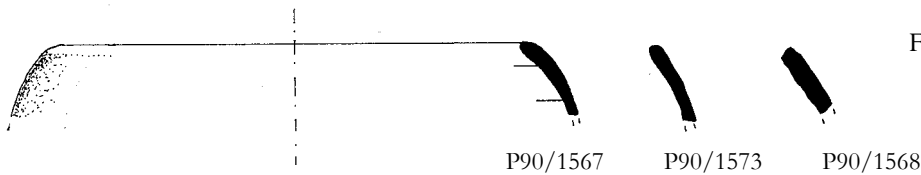

Fig. 40. Tripod cooking pots with hole-mouthed rim (Type C). (Scale 1:4).

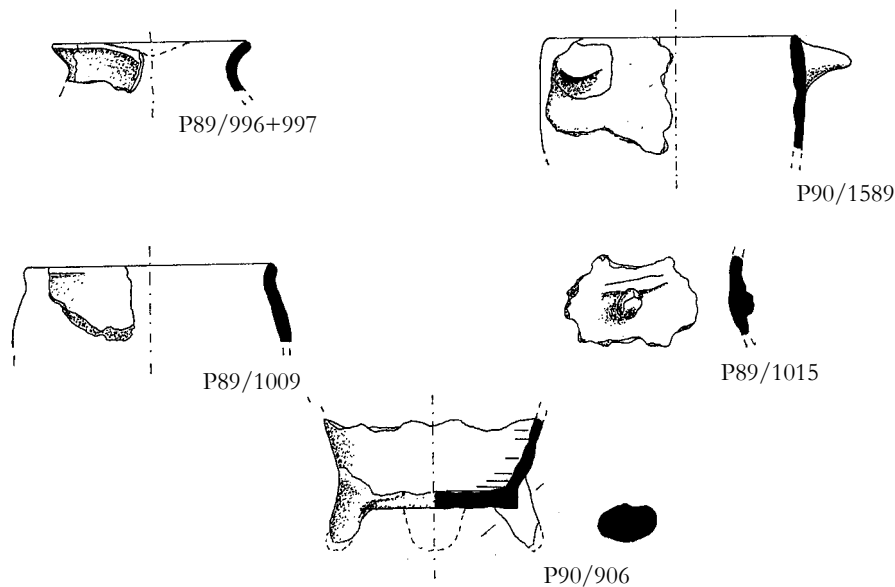

Fig. 41. Small cooking pots. (Scale 1:4).

at other LM IB sites (e.g., Palaikastro) and also from later contexts (e.g., Knossos).⁶⁸

A.4) Tripod cooking pots – hole-mouthed pots (Type C)⁶⁹

Another variety of tripod cooking pot has an incurving rim and profile similar to that of hole-mouthed jars. In other instances, the shape can resemble Type B cooking pot profiles but with the mouth completely open.

In House II.1, very few examples of this type were recognized (e.g., P90/1037/sn21, P90/1567, P90/1568, P90/1573). Because all are rim sherds (Fig. 40), it is not possible to reconstruct the complete shape;⁷⁰ however, good comparisons have been found at Palaikastro in MM IIIB contexts.⁷¹ Given the small numbers and the date of the parallels at Palaikastro, this type probably represents sherd material from earlier phases (i.e., pre-LM IB) of House II.1.

B) Small cooking pots

Among the typical cooking pots from Room Epsilon were very small vessels that were not well preserved. Their presence must be emphasized because they appear to form part of the typical “cooking set” in the house.

The first example (P89/996) (d. 10 cm, th. 0.3

⁶⁸ ME and loci: P90/1570 (Room Epsilon, locus 1). For comparisons, see Palaikastro (Sackett & Popham 1970, NP 66 pl. 64f) and Knossos (Popham 1984, 6, 47, 66 and 74, H187, H188 and L48, pl. 86g, f; pl. 162.9–11).

⁶⁹ Martlew 1988, 422, B I.

⁷⁰ ME and loci: P90/1567 (Room Epsilon, locus 2); P90/1568 (Room Epsilon, locus 3); P90/1573 and P90/1037 sn21 (Room Epsilon, locus 1).

⁷¹ Large and medium-sized vessels from MM IIIB Palaikastro (Knappett & Cunningham 2003, 135–6, nos. 177–80, figs. 20–1, B6R1/3; 157 nos. 287, 289 and 296, fig. 37, EP 87). The shape, however, appears to be attested from MM IIIB (Tzedakis & Martlew 1999, 89, 91 and 162, nos. 54, 57 and 145 from Apodoulou and 96, 146, no. 67 and 128 from Monastiraki).

cm) has a sharply everted rim with spout, and probably had a globular profile that typologically may be related to Type A cooking pots or coarse jugs. The second (P89/1009) (d. 14 cm, th. 0.3 cm) has an elongated profile and plain rim, connecting the vessel to cooking pots of Type AB or B. The same is also true for P90/1571 (d. 12 cm, th. ca. 0.5 cm). The third example (P90/1589) (d. 14 cm, th. 0.5 cm) preserves the rim, lug handle, and body of a small vessel that resembles Type B cooking pots. The fourth example (P90/906) consists of the base of a small tripod cooking pot (base d. 9 cm, th. 0.5 cm). Finally, P89/1015 preserves a tiny body sherd with a possible lug handle (th. 0.5 – 0.7 cm) and likely belongs to a small cooking pot (Fig. 41).⁷²

C) Cooking trays

The term “cooking tray” is highly conventional and does not explain the function of the vessel. In most cases, the presence of burn marks confirms an association with fire, though this is not always the case.⁷³ These vessels may have been used not only for cooking or other processes involving fire, but also for serving or storing food. Given this possibility, the term “baking pan” might provide a more accurate description.⁷⁴ When used over fire, the trays probably provided a warm cooking surface. When used with large lids, they could also have served as portable ovens.⁷⁵

The trays are typically round and have a flat base, low side-walls, which are either straight, slightly flared, or slightly convex, and a rounded or square lip, which is often pulled out to form a spout. The type of handle varies – some are horizontal, while others are pierced lugs. Most trays are provided with three legs, though there are examples without supports, and all are hand-made. The interior surface and exterior of the rim are generally water-wiped and smoothed or slipped, while the rest of the exterior and bottom are left rough.⁷⁶ The dimensions vary considerably, with heights from 2 to 5 cm and rim diameters from 18 to 40 cm.⁷⁷

The extreme variation in the shape likely explains why previous studies have failed to propose either a clear typology or chronological develop-

ment of the form.⁷⁸ The examples from House II.1 at Petras are thus important because they illustrate a major distinction between thinner/smaller (Type A) trays and thicker/larger (Type B) examples.⁷⁹

Room Epsilon of House II.1 did not yield any cooking trays, but four trays were identified in the preliminary ceramic study from other parts of the house (three of the thin variety and one of the thicker type).⁸⁰

⁷² ME and loci: P89/996 (Room Epsilon, northeast corner); P89/1009 and P89/1015 (Room Epsilon, locus 2); P90/906 (Room Epsilon, locus 3); P90/1571 and P90/1589 (Room Epsilon, locus 1).

⁷³ The examples from the Mochlos Artisans' Quarter show little sign of contact with fire (Barnard & Brogan 2003, 33); see also Hallager & Hallager 2000, 160–1.

⁷⁴ There are shapes among the Bronze Age pottery from central and southern Italy, Sicily and Sardinia that resemble Minoan trays, including those called “tegami” (pans) or “teglie” (baking pans). Among Nuragic vessels, a general distinction is made, almost exclusively on the basis of morphological features, between “tegami” (walls taller than 5–6 cm) and “teglie” (walls shorter than 4–5 cm). See Belardelli *et al.* 1999, 376–7, fig. 3, nos. 1–2; Adamo *et al.* 1999, 488, fig. 9, nos. 185–6; Antona *et al.* 1999, 499, fig. 1, nos. 3–4 (teglie) and 5 (tegami); Bagella *et al.* 1999, 517, fig. 3, nos. 3–7. On Nuragic wares, see also Campus & Leonelli 2000. Baking pans are also recognized in the traditional pottery production of modern Crete (γουβέτσι); see Blitzer 1984, 149–50, fig. 18, 5.10.

⁷⁵ Borgna 1997, 200.

⁷⁶ Borgna 1997, 193.

⁷⁷ Hallager & Hallager 2000, 160–1; Barnard & Brogan 2003, 86.

⁷⁸ “[...] it was not considered worthwhile to deal with variations on an individual basis” (Martlew 1988, 424); Betancourt 1980, 7. See Types AIII, DIII and F in Martlew 1988.

⁷⁹ In Hallager & Hallager 2000, 159, 168, fig. 32, “cooking trays” are smaller and without legs, while “tripod cooking trays” are larger and employ feet. The following description draws on evidence from House II and House I together with other published examples from Mochlos.

⁸⁰ ME and loci: thinner trays P89/375 (Room Gamma); P89/770, II 5; P90/843 (Room Kappa); thicker tray P89/812 (II 4, locus 1b). Comparanda: Kommos, Oblique House, LM IA-B (Watrous 1992, 10–1, no. 187, pl. 20); Kommos, other contexts, MM III (Betancourt 1980, thin tray C429 and thick tray C643, fig. 8, with other thick trays from LM IIIB contexts); Seli Kamilari and Phaistos: a thin LM IA tray from the Volakakis plot (La Rosa & Cucuzza 2001, XX-33, 103, fig. 262); Mochlos, the LM IB Artisans' Quarter Building A (IB.581, IB.582, IB.587, IB.588, IB.589, IB.593 and IB.600),

Fig. 42. “Thin” cooking trays (Type A, P89/375, P89/770 and P90/843), “thick” cooking trays (Type B, P89/812) and trapezes (P90/1215). (Scale 1:4).

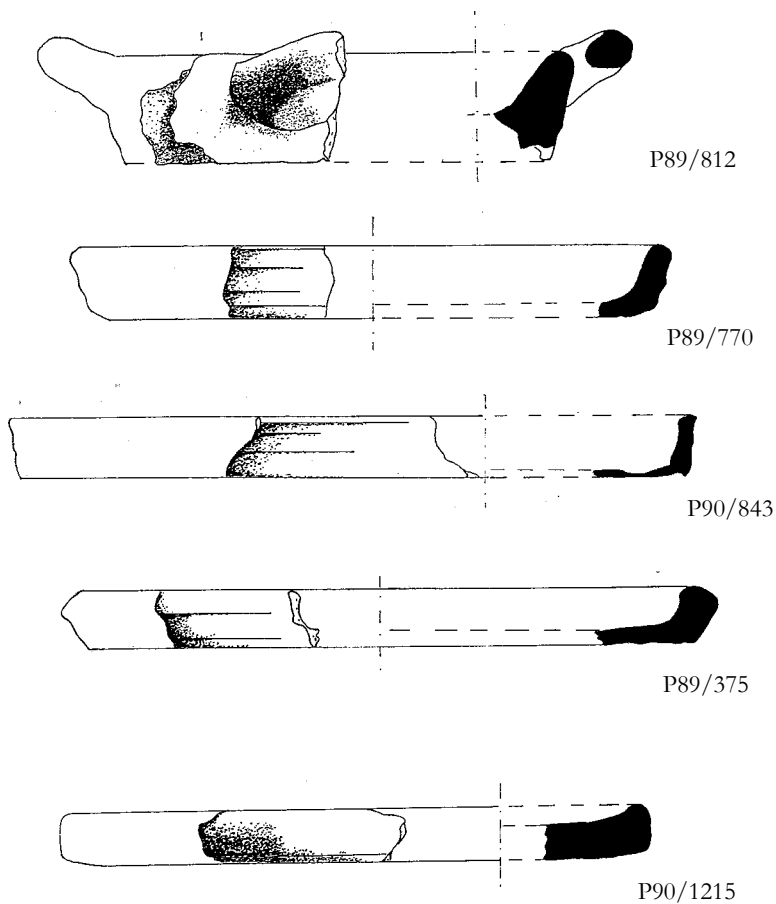

C.1) “Thin” cooking trays (Type A)

Thin cooking trays are made in normal cooking fabric, and their walls are on average ca. 1 cm (0.8 – 1.5 cm) thick.⁸¹ The rim diameter varies from 20 to 50 cm, while the majority cluster between 35 and 45 cm. The base of these vessels is not thick, and traces of legs are preserved in a few cases (Fig. 42, P89/770 and P90/843).

C.2) “Thick” cooking trays (Type B)

Thick cooking trays are made in a distinctive fabric similar to that of trapezes and fire-stands (also known as spit-rests);⁸² this fabric consists of a very coarse mixture with many different inclusions, some of which appear to have been smashed into powder. These vessels are considerably larger than the Type A trays, with walls 2–3.5 cm thick (in some cases even 4.8 cm) and bases (when preserved) of similar dimension. The rim diameters vary from 35 to 60 cm, with the average size between 40–45

cm, and the preserved handles are thick and round in section (up to 3 cm). Most trays are provided with three thick legs, but the smaller fragments can easily be confused with the so-called trapezes (Fig. 42, P89/812).

Building B (IB.583, IB.584, IB.592, IB.594, IB.595, IB.598, IB.599 and IB.602), the pottery kilns (IB.585, IB.586, IB.596, IB.597) and Chalinomouri (IB.590, IB.591, IB.601) in Barnard & Brogan 2003, 86–7, figs. 50–1 (most are thick trays with a few exceptions (IB.583 and IB.596); and Pseira LM IB Area BX (Betancourt & Davaras 1999, fig. 40, thick tray BX5 and thin trays BX8–9).

⁸¹ P89/375 (h. 3 cm, d. 33 cm, th. 2 cm) which has low side walls and a squared rim; P89/770 (h. 3.8 cm, d. 30 cm, th. 1.1 cm) which has a more rounded profile and rim and traces of burning on the exterior; and P90/843 (h. 3.2 cm, d. ca. 48 cm, th. 1.1 cm) which has a straight profile and squared rim.

⁸² P89/812 (h. 5.6 cm, d. 48 cm, th. 2.4 cm) has a straight, slightly flaring profile and a thick horizontal handle attached below the rim.

D) *Trapezes*⁸³

Trapezes are disc-shaped and have very low, almost non-existent sidewalls. The interior surface and exterior of the rim are generally water-wiped and smoothed or slipped. The rest of the exterior and the bottom of the vessels are left rough. These vessels are hand-made, in a fabric very similar to that used for thick trays and fire-stands/spit-rests. The size of the vessels varies (rim diameters from 30–40 cm and heights from 0.3 to 3 cm).

This shape is not common, and its function is still unclear. Trapezes may have been used like cooking trays that were heated over fires to make bread or “pita.” It is also possible that some fragments have been misidentified and instead belong to lids for pithoi (especially the very flat ones) or to drain-heads (especially those with low side-walls). Only one example is recorded from House II.1, P90/1215, and it has a slightly raised border (d. 44 cm, h. 2.5 cm, th. 1.6 cm) (Fig. 42, bottom).⁸⁴

E) *Cooking dishes*

Very few cooking dishes were found in Room Epsilon, a feature also observed in the larger assemblage from House II.1. Although it is one of the most common Minoan cooking shapes, the function of the cooking dish is still widely debated.⁸⁵ These vessels were probably placed on a bed of coals to create a warm surface for toasting, roasting, frying, and cooking thin bread. The deeper examples would also have been suitable for making soups, while other cooking dishes could have been used to make cheese and dyes.⁸⁶

Cooking dishes have an elongated shape with a rounded bottom and large spout on the short, straight side. They are made with extremely thin walls in order to allow the heat to pass through, while the rims tend to be thicker. The interior surface is generally water-wiped and smoothed, while the exterior is left rough. The dishes are hand-made with rim diameters from 30 to 90 cm, with an average between 40 and 60 cm.⁸⁷ In excavations, they are usually found broken and re-used in various ways, suggesting the vessels were fragile and used only a few times before breaking.⁸⁸

E.1) Medium-sized cooking dishes

In Room Epsilon, 21 rim fragments of cooking dishes have been found.⁸⁹ These vessels are approx-

⁸³ Further comment on this shape is provided by E. Banou's response to this paper.

⁸⁴ ME and loci: P90/1215 (II 1, locus 1).

⁸⁵ Kommos: Betancourt 1980, 5–7 (where the shape is compared to the modern oriental *wok*); Mook 1999 (Kavousi, LM IIIC); Gerondakou 2000 (Zakros, LM I); Hallager & Hallager 2000, 160, 168 (Kastelli Khania, LM IIIC); Barnard & Brogan 2003, 82–3 (Mochlos, LM IB). See also Popham 1984, 174 (Knossos, Unexplored Mansion, LM II) and Borgna 1997, 200 (Phaistos, LM IIIC). The publication of the Mochlos material seems to answer the need for a “[...] common terminology and specific definitions if we are to understand the function, development, and cultural significance of this shape. [...] At this time, there is a great need for rigorous identification of cooking dishes in Minoan ceramic assemblages and for standardizing the nomenclature in publication” (Mook 1999, 504, 508).

⁸⁶ In many ways, they have the same use as a kitchen plate or the traditional Cretan *μαγκάλια* (Blitzer 1984, 149–50, fig. 18, 5.8 and Sarpaki 2001, 39). A large and updated discussion of the subject can be found in Barnard & Brogan 2003, 83.

⁸⁷ On the basis of the impressions found on the underside of some vessels, it is argued that cooking dishes were hand-made in a mold, either in woven baskets or directly on the ground. The rims were probably attached separately while the vessels were still wet, and the interior was then smoothed. In order to cover the join, clay was probably drawn up from the interior, thereby producing the characteristic thinning out of the bottom. At LM IIIC Kavousi, the rims were wheel-made and regular (Mook 1999, 506–7).

⁸⁸ Barnard & Brogan 2003, 82. For this reason, it is generally agreed that these dishes were left near or inside the hearths. At Kommos, fragments of cooking dishes appear in open hearths, while fragments of cooking pots prevail in the closed ones (Shaw & Shaw 1996, 225). At Kavousi, the cooking dishes are made of three different fabrics, thus pointing to different workshops (Mook 1999, 506, n. 23). The fragile and irregular shape of the vessels probably excludes their use in pairs as portable ovens (Hallager & Hallager 2000, 160 in response to this suggestion in Betancourt 1980, 7).

⁸⁹ ME and loci: squared rim: P89/1014 (Room Epsilon, locus 2); P89/1022 and P89/1023 (Room Epsilon, removal of stones from a hypothetical wall E); P90/1579 and P90/1590 (Room Epsilon, locus 1); P90/1595 (Room Epsilon?); P90/103/11, P90/115/27 and P90/242/1 (Room Epsilon, locus 1). Larger examples: P89/1061 and P90/1546 (Room Epsilon, locus 1). Rounded rim: P89/1021 (Room Epsilon, removal of wall, northeast corner); P90/1572, P90/1581, P90/1582, P90/103/20 and P90/258/1 (all Room Epsilon, locus 1). Badly preserved: P89/bag 4 and P89/bag 5 (Room Epsilon, removal of east wall); P90/1546, P90/1282 and P90/115/25 (Room Epsilon, locus 1).

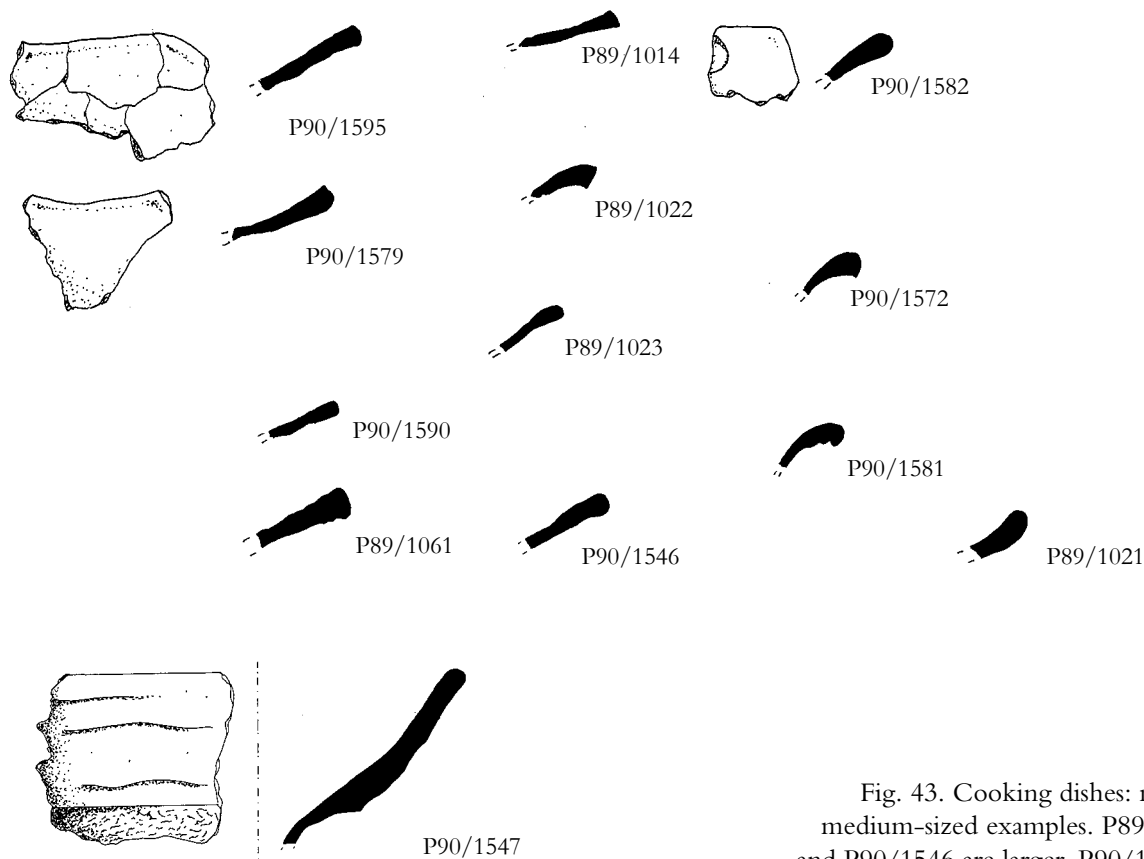

Fig. 43. Cooking dishes: mostly medium-sized examples. P89/1061 and P90/1546 are larger. P90/1547 is exceptionally large. (Scale 1:4).

imately 1 cm thick and have estimated diameters from 20 to 60 cm. Most have a squared rim, including P89/1014, P89/1022, P89/1023, P90/1579, P90/1590, P90/1595, P90/103/11, P90/115/27, P90/242/1. In addition, two examples (P89/1061 and P90/1546) are larger than the others, suggesting that a larger version was also produced (Fig. 43).

Another group of cooking dishes employs a rounded rim: P89/1021, P90/103/20, P90/1572, P90/258/1, P90/1581, P90/1582 (Fig. 43). P89/1021 is the only example with an incurving rim, indicating that it does not form a spout.⁹⁰ The other fragments (P89/bag 5, P89/bag 4, P90/115/25, P90/1546, P90/1282) are poorly preserved.

E.2) Large cooking dishes

Room Epsilon also contained a rim fragment from a very large cooking dish: P90/1547.⁹¹ The rim itself is 7 cm high (Fig. 43, bottom). Dishes of this

size are uncommon, which raises an interesting question regarding its use in this context.⁹²

F) Fire-stands/spit-rests

Three fire-stands were recorded from House II.1, including two from Room Epsilon.⁹³ The defini-

⁹⁰ Rim fragments from both the side and spout are known from Kommos (Betancourt 1980, fig. 3, C733, C886–92, LM I-II) and the Artisans' Quarter and Chalinomouri at Mochlos (Barnard & Brogan 2003, figs. 49–50, IB.511–36 from the spout, IB.538–63 from the side, LM IB). Additional LM IB examples are known from Pseira, Area BX (Betancourt & Davaras 1999, fig. 40, BX 6–7).

⁹¹ ME and loci: P90/1547 (Room Epsilon locus 1).

⁹² Large examples are known from later periods (LM IIIC): see Hallager & Hallager 2000, pl. 46, 71.P0831 (Kastelli Khania) and Mook 1999, pl. CX (Kavousi).

⁹³ ME and loci: P89/519 (Room Epsilon, locus 1); P89/762 (Room Epsilon, removal of stones from hypothetical wall E); P91/1982 (Rooms Theta and Iota).

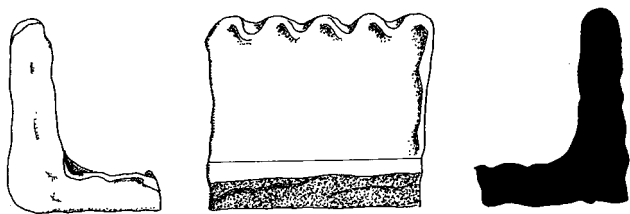

P89/519

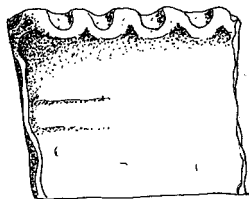

P89/762

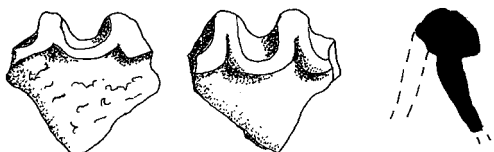

P91/1982

Fig. 44. Fire-stands/spit-rests. P89/519 Scheffer Type A; P89/762 and P91/1982 Scheffer Type C. (Scale 1:4).

tion and function of the fire-stand/spit-rest is still uncertain; the type of fabric used and traces of burning sometimes found on the sides point to a connection with cooking fires.⁹⁴ Scheffer identified three types: A, B and C (but his Types A and B are probably the same).⁹⁵ The stands were likely used to hold spits with meat over coals or cooking pots that did not have legs. At Petras, their fabric is quite distinctive, and very similar to that used to make the thick trays and trapezes.

F.1) Scheffer Type A

One of the examples from Room Epsilon, P89/519, belongs to Type A. It is “L-shaped” in section and shows signs of being cut with a string on three sides. The surface is self-slipped and smoothed, with the

exception of the base which was left rough. It is 10.5 cm high and 2 cm thick (Fig. 44, top), and a series of depressions on the rim have been interpreted as the rests for spits.

F.2) Scheffer Type C

Two more fire-stands, one from Room Epsilon (P89/762) and another from a different room (P91/1982), belong to Type C (Fig. 44, center and bottom). This vessel type resembles a pan or plate made with depressions in the rim, and it was likely used to hold spits above charcoal.

A summary of the cooking wares

The presence of so many cooking vessels points to the frequent use of fire in Room Epsilon. We should, however, keep in mind that most of the cooking vessels were stored upstairs at some distance from the central hearth of the room.

The cooking ware shapes suggest a date for the assemblage early in LM IB. Some vessels, like the Type C hole-mouthed pots of MM IIIB, may represent antiques or fragments that were built into the floor packing. The large number of both “traditional” (i.e., LM IA) Type B tripod cooking pots and “transitional” Type AB pots is more significant, as it suggests that the transition from Type B had not ended. At the same time, the presence of LM IB Type A pots in slightly larger numbers suggests that this shape was a recent introduction, which should thus be placed early in the LM IB period (Fig. 29). This chronological picture is broadly confirmed by M. Tsiopoulou’s analysis of the fine wares.

A comparison of the LM IB cooking wares from House II.1 with those from LM IA House I pro-

⁹⁴ A critical review of the shape is provided in Hallager & Hallager 2000, 162. See also Georgiou 1983, 78–80. A full discussion and typological analysis is given by Scheffer (spit-supports with scalloped tops), where three different shapes are recognized (Scheffer 1984, 155–6, fig. 1). See also Chapouthier & Demargne 1942, 51 (where Types A and B are illustrated) and Levi 1988.

⁹⁵ Scheffer 1984.

vides a nice conclusion to this study, but one that will remain preliminary until the study of House II.1 is finished. It is also limited by the fact that neither house contains complete or restorable vases.⁹⁶

Two points are immediately visible when we compare the two sets of data (Fig. 45):

- Cooking pots and dishes occur in almost equal quantities in both structures.
- House I contained several trays and trapezes, which are absent from House II.1. While this pattern may point to a different function for each structure, the study of House II.1 must be completed before we can be certain.

The distribution of the cooking pot types (Fig. 46) is broadly similar in both structures; however, House I has fewer Type A (globular) cooking pots and intermediate Type AB pots and more Type B pots. Among the Type B pots, the majority have open mouths similar to the so-called “Type C” cooking pots and conical pans. This evidence is consistent with the earlier LM IA chronology of House I. One of the future questions to be examined at Petras is whether this change in the preference of certain cooking shapes from LM IA to LM IB (at least in eastern Crete) coincided with any meaningful changes in cooking practices.

Conclusion to the LM IB pottery from Petras House II.1 (M. Tsipopoulou)

The ceramic study of House II.1 is still in progress, but the pottery presented here provides a representative sample of what one might expect to find in other LM IB levels at Petras. In fact, Petras fits easily into the general picture of East Cretan ceramics, with the closest parallels coming from Mochlos and Palaikastro. It appears likely that much of the pottery consumed at Petras in this period was actually produced at Palaikastro, unless the characteristic orange clay was imported to Petras and then used by the local potters. In the exemplary publication of Mochlos Period III by Barnard and Brogan, the importance of regional tradition (or rather, traditions) is stressed. Petras should, undoubtedly, be consid-

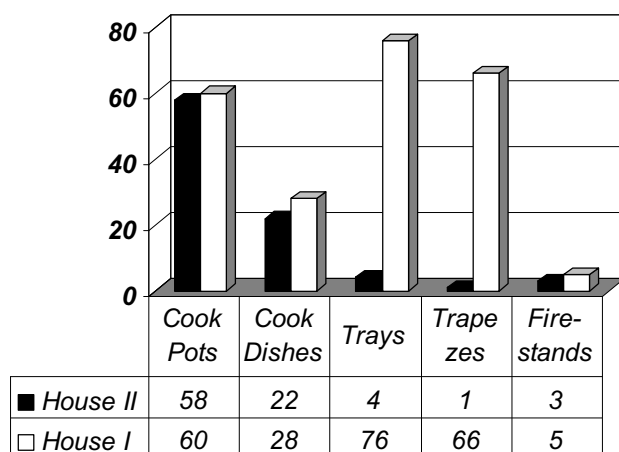

Fig. 45. Comparison between House I (LM IA) and House II (LM IB): the main shapes of cooking wares.

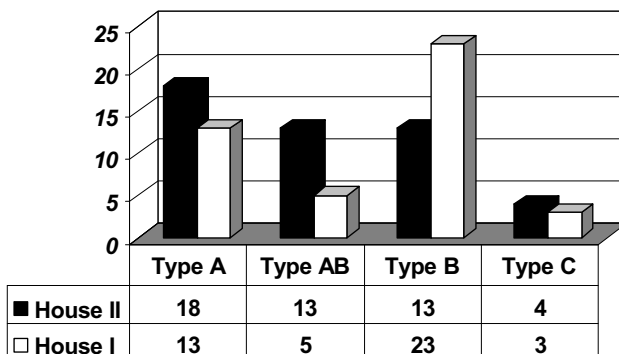

Fig. 46. Comparison between House I (LM IA) and House II (LM IB): the types of cooking pots.

ered a local tradition, but this is difficult to illustrate because so few decorated vessels have good parallels from the area. Moreover, given the poor quality of the extant assemblage at Petras, it is still not possible to determine whether the LM IB destruction at the site happened at an early phase of this period. For now, the available evidence indicates that there was only one LM IB destruction at Petras. The relationship of this event to the other destructions recorded across the island is not easy to establish with any certainty. We would only note the total

⁹⁶ The list of complete or restorable cooking pots from Petras House I includes six cooking pots (one of Type A, one of Type AB, and four pans of Type B), while the number from Petras House II.1 includes five cooking pots (three of Type A, one of Type AB, and one pan of Type B).

absence of the shapes and styles that are currently considered to be representative of a late or final LM IB date, such as the Alternating Style. At this point, we can suggest that the LM IB destruction took place earlier in LM IB, and consequently that this period was a short one at Petras.

It is also worth noting that there are some signs of continuity at Petras from MM II and LM I. Petras appears to have been a substantial polity already in the Protopalatial period, during which time it shows few links to Central Crete (at least not North-central Crete). This pattern continues into the LM I period, especially LM IB, when Petras still appears not to have played an important role in Knossian interests in East Crete. Instead, Knossian interests were best (or even exclusively) served by the Palace of Zakros. Thus, Petras was left to continue in a rather diminished capacity, trying, perhaps

only briefly in LM IB, to cope with this new dynamic, until it was finally destroyed and abandoned. The important point to be emphasized, however, is the fact that the Petras Palace and its administration survived into LM IB, even if under stress. During this period of possible Knossian hegemony over eastern Crete, it is not easy to understand the exact form or role of the Petras Palace. It may simply be that Petras was considered insignificant and was thus left to live with the memories of its past glory and even allowed to continue using the hieroglyphic script into LM IB. The Petras economy was based primarily on agricultural resources and was administered by a centralized bureaucratic system, unlike that of Mochlos, where maritime contacts and trade played a much more important role. Petras may thus not have been able to survive and adapt to the new circumstances in LM IB.

An introduction to the LM IB pottery from Poros: a response to Metaxia Tsipopoulou and Maria Emanuela Alberti*

Eleni S. Banou

For many years Metaxia Tsipopoulou has been working in eastern Crete, especially in the region of Siteia. Her systematic excavations and research at Petras have made it one of the best understood sites in prehistoric Crete. For this conference, Tsipopoulou presented an informative paper outlining the history of settlement (including burial practices) at Petras from the Final Neolithic to LM IIIB, before focusing on the LM IB phase.

The pottery from Room E of House II.1 forms the core of her discussion, and it fits well within the LM IB tradition. For example, the pithoid jars decorated with double axes and a molded rim (a feature common in East Crete) and a jar with conglomerate pattern have close parallels at Pseira, Mochlos, Gournia and Palaikastro.¹ On the other hand, the handleless bell cups with light-on-dark spiral decoration suggest that the LM IA ceramic tradition is still present; in fact, this light-on-dark style actually belongs to the even earlier MM III tradition. The absence of the Special Palatial Tradition (SPT) at Petras is noteworthy; however, this pattern may be explained in part by the marginal character of the houses at the site, which likely would not have had access to these wares. Another possible explanation, offered by Tsipopoulou, is that limited relations between Petras and Knossos in the LM IB period may have prevented SPT vases produced in Knossian workshops from reaching sites in the Siteia area.²

The second half of this paper introduces a deposit of pottery from the Liouni Plot at Poros in Herakleion. I believe it provides evidence for the existence of a transitional LM IB/II ceramic phase. A comparison of the Petras material and the Liouni deposit clearly indicates that the pottery from

Room E of House II.1 at Petras should be dated earlier than the Poros assemblage and perhaps early in the LM IB ceramic sequence.

In the second part of the Petras presentation, Tsipopoulou's colleague, Dr. Emanuela Alberti covers a long neglected component of Minoan ceramics – cooking wares. It is well known that the impetus for studying cooking wares can be traced to the classic article on the subject by Betancourt.³ Since then, scholars have paid much greater attention to cooking vessels, recognizing their value not only for interpreting specific contexts, but also for the information they provide about the Minoan diet. The best example of such work was the exhibition organized by the Hellenic Ministry of Culture in 1999: *Minoans and Mycenaeans-Flavours of their Time*, which examined the gastronomic habits of the Minoans on the basis of cooking wares and organic residue analysis of cooking pots.⁴

* I would like to express my gratitude to Tom Brogan and the INSTAP Publication Team for their assistance in the processing of this material. In particular, I would like to thank Kathy Hall for the careful conservation of the pottery, Douglas Faulmann for the drawings, and Chronis Papanikolopoulos for the photography. This work was conducted in 2004 at the storerooms of the Herakleion Museum and the Stratigraphical Museum at Knossos. I sincerely thank both institutions for providing their facilities and Eva Grammatikaki and Doniert Evely for their help.

¹ For Pseira, see Banou 1995c, 35, fig. 38 AB10 and fig. 51 ACD98; Betancourt & Banou 1999, 135, figs. 14–5BQ2, BQ5. For Mochlos, see Barnard & Brogan 2003. For Gournia, see Betancourt & Silverman 1991, fig. 20, no. 579. For Palaikastro, see Knappett & Cunningham 2003, 107–87.

² Müller 1997; Betancourt 2004.

³ Betancourt 1980.

⁴ Tzedakis & Martlew 1999.

Alberti's careful approach to the shapes found in the Petras cooking assemblage allows her to date the group to early LM IB on the basis of statistics rather than cooking fabrics.⁵ One should be cautious, however, when identifying specific cooking shapes as chronological markers because the shapes of cooking wares do not change dramatically over time.

Alberti's typology includes all of the different forms of cooking wares found in Room E of House II.1 at Petras. Not surprisingly, the dominant shape is the tripod cooking pot, which occurs in a variety of shapes and sizes. Note that:

1. It is generally agreed that Betancourt's Type B tripod cooking pot is earlier than the Type A form. Type B pots were produced over a long period of time, from MM IB to LM II, though Betancourt assigns them primarily to MM III and LM IA. These vessels appear in various sizes and shapes, usually with a wide mouth, straight or slightly convex (i.e., slightly globular) profile, two horizontal handles, thick legs that are oval in section, and occasionally a small spout. The overall appearance of the pot is that of a tall vessel with an elongated body.
2. Pots with the same features as Type B, but with a narrow mouth and pronounced globular profile, are identified as Type A and are found mainly in deposits dating to LM IB and later.

In addition to Betancourt's Type A and Type B, Alberti identifies two more types: Type AB (a combination of A and B) and Type C (a variation with a hole-mouth). She also examines a range of other cooking shapes, like dishes, trays, fire-stands and trapezes/plates.

After providing a preliminary report on the cooking pots from House II.1 at Petras, Alberti concludes her presentation with a comparison of the cooking ware assemblages from House I (LM IA) and House II (LM IB). Although the author stresses that the results are still in a preliminary form, it would have been more useful if the statistics, as shown in the chart, had distinguished the number of complete or nearly complete vessels and the specific shapes.

Finally, Alberti emphasizes the fact that the ty-

pology of cooking vessels shows a strong continuity through LM IA. She then raises the possibility that the Type AB cooking pots (with an elongated body and convex profile) may represent a "key" transitional phase in cooking shapes between LM IA and LM IB. There is, in fact, a subtle difference between Betancourt's Type B and Alberti's Type AB, primarily in the rim diameters. A comparison of a Type AB cooking pot from Petras with a Type B MM III example from Kommos⁶ confirms that the Type AB pots do have smaller diameters. Given that the difference is small, it may be preferable to avoid the term Type AB and simply label vessels of this shape as Type B. At the same time, I agree with Alberti that there is a trend towards cooking pots with smaller rim diameters in East Crete during LM IB.⁷

Further light on the development of cooking pots is provided by the new assemblage of LM IB material excavated in the Liouni Plot at Poros Herakleion.⁸

Betancourt's classification and chronological implications regarding cooking pots remain valuable on a broad level. To the published Type B examples from Kommos, which are mainly MM IIIB-LM IA in date, we can now add two unpublished examples of Type B from the MM IIIB/LM IA deposit at Pera Galenoi (Fig. 1a). This shape does, however, clearly continue in several LM IB and LM II deposits; examples are found in the LM IB and LM II deposits at Kommos,⁹ the LM IB deposits at Splanzia Khania,¹⁰ a stratified late LM IB deposit from the Liouni Plot at Poros in Herakleion (Fig. 1b), an LM IB deposit at Gournia,¹¹ and an LM IB deposit at Pseira.¹² Moreover, Type A cooking pots (usually dated to LM IB and later) are found

⁵ Statistics that calculate the number of whole vases or largely restorable vases and diagnostic sherds in each deposit have proven extremely useful in Minoan pottery studies. Here Alberti is also trying to attribute a chronological significance to the percentages, which is challenging.

⁶ E.g., Betancourt 1990, fig. 26.

⁷ Barnard & Brogan 2003, figs. 47–8.

⁸ Banou 1996, 630–2.

⁹ Watrous 1992, fig. 16, no. 218, fig. 26, no. 581.

¹⁰ Tzedakis & Martlew 1999, fig. 77.

¹¹ Betancourt & Silverman 1991, fig. 15, no. 519, fig. 16, no. 520.

¹² Floyd 1998, fig. 3 BS/BV35.

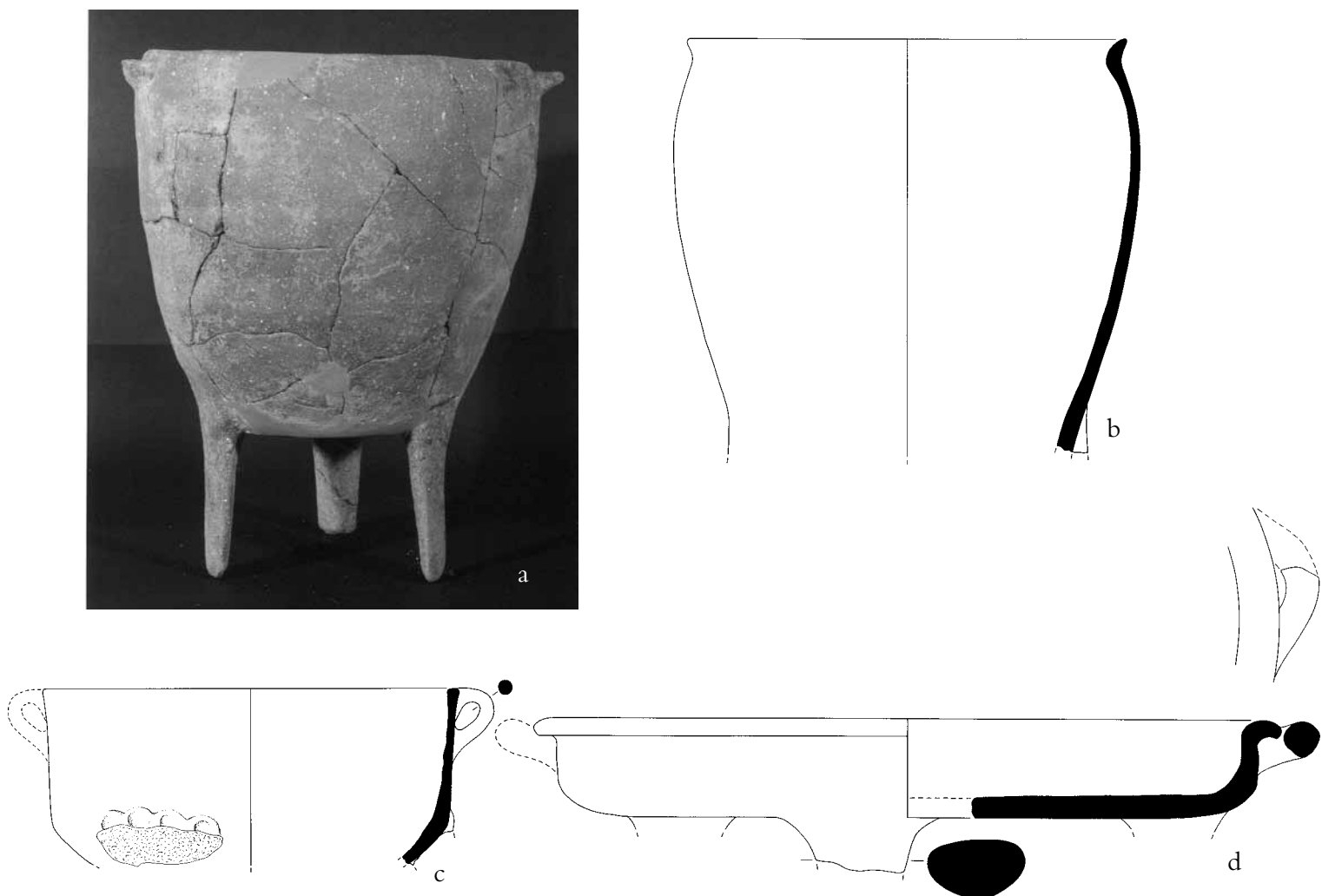

Fig. 1. Cooking vessels from Pera Galenoi (a) and Poros, Herakleion (b-d).

in both of the LM I houses (I and II) at Petras, and they occur in earlier Neopalatial deposits at Pera Galenoi (Fig. 1a). I would even suggest that we add another parameter to this classification, namely the ratio of body to leg size. What characterizes the cooking pots, particularly in the MM III and LM I periods, is the relation of the elongated body to the legs (3:1), regardless of the body profile (vertical or globular). It is only in LM IB and LM II, when the body becomes squat, that the shape conveys a body to leg ratio of 1:2. One slight drawback to using this criterion is that complete pots or at least complete profiles are required; however, every significant deposit furnishes at least one or more restorable cooking pots and the legs are usually preserved in full length. Taking this parameter as a

broad chronological measure, I suggest that cooking pots with an elongated body are produced from MM II through LM IB, while those with a short/squat body should be assigned to LM IB and later. The smaller and miniature pots of the pan or cup type with a vertical handle (as recorded from House II.1) belong to a different category (as they represent another vessel type).

This new distinction provides an additional means of studying the cooking pots from House II.1 at Petras. Using the ratio of body to leg height, we find that some Type A examples and the “crucial Type AB” do not provide clear evidence for a later date. Indeed, very few Type A cooking pots meet the proposed 1:2 body-leg ratio of LM IB. But this should not be surprising and may in fact



Fig. 2. Pottery with LM IB features from the Liouni Plot.

corroborate Alberti's conclusions. It suggests that the cooking ware from House II.1 remains within the MM IIIB-LM IA tradition, with only a few Type A examples looking towards the developments of LM IB.

I would like to conclude my review of the Petras material with a few words on the other cooking shapes. The pan-shaped vessels from House II.1 with plastic decoration between the front legs find a good parallel in the LM IB Late deposit from Poros (Fig. 1c). These pan-shaped tripod vessels should not, however, be confused with Type B cooking pots; they are a different shape. In addition, the size and forming techniques of the so-called plates or trapezes from Room E recall the unpublished "vat slabs" from Kommos. They do not seem to be plates like the complete set that was found in an MM III-LM IA deposit at Galatas.¹³ An example from Pera Galenoi also suggests that this shape can be traced back to an even earlier period (MM IIB).¹⁴ For this vessel form at Petras, I would suggest the

term "slab." The function of these pots can only be speculated, but cloth dyeing is certainly among the possibilities. Finally, cooking trays or baking pans are usually provided with legs, like the complete example from the LM IB Late deposit from Poros (Fig. 1d).

The LM IB/II deposit from the Liouni Plot at Poros, Herakleion

In 1996 as an Epimelete of the 23rd Ephorate of Antiquities in Herakleion, I conducted a brief rescue excavation in the Liouni Plot in the suburb of Poros, Herakleion. This plot is located 550 m inland from the modern harbor. Only Late Minoan deposits were found in the excavation, and they contained a rich assemblage of pottery dating from

¹³ Rethemiotakis 1994, 706, pl. 228b.

¹⁴ Banou & Tsivilika 2006.

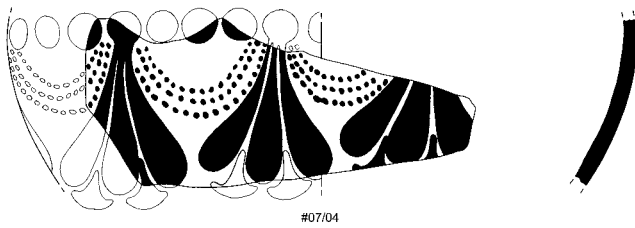

Fig. 3. LM IB pendants and festoons.

LM IB to LM IIIB.¹⁵ Due to the limited size of the plot, a small trench (Trench V) measuring 3 x 2 m was opened. This trench exposed part of one ancient room with remains of a large wall, constructed of dressed blocks, on the north side and traces of a small square hearth on the east. This space probably served as a kitchen.¹⁶

A large assemblage of pottery, part of a destruction deposit, was recovered from the interior of the room. This deposit, consisting of Levels 7b and 8–10, proved to be particularly informative regarding the topic explored by the LM IB workshop and in particular, the tantalizing issue of the existence of a late LM IB period or a transitional phase between LM IB and LM II. This paper is not intended to be a detailed presentation of the material from the Lioumi Plot, which will be published elsewhere, but is instead directed at the specific question of possible LM IB sub-phases.

The deposit under discussion consists mainly of complete or restorable vases and exemplifies the following general features:

1. Stratigraphically, it lies between an (upper) LM II-III A1 context (Levels 4–7 and 7a) and bedrock (lower).
2. The pottery was found buried within a thick burnt layer which represented the destruction deposit of the building (i.e., a floor deposit).
3. The LM IB style (no LM IA was recognized) is reinforced by the presence of the Special Palatial Tradition (SPT), including excellent examples of Knossian quality Marine Style. The deposit contains more than sixty complete vases, occurring in three different Minoan fabrics – fine, coarse buff-tempered and coarse red-tempered (for cooking activities) – and one non-Minoan fabric.
4. Conical cups, semiglobular cups (both mono-

chrome and decorated), and jugs form the majority of shapes.

5. Certain shapes and decoration are canonical for LM IB; however, a few shapes and motifs appear to anticipate the subsequent LM II ceramic style.

Typical LM IB features in the deposit

Fine fabric (plain and decorated)

The most popular shape is the small, thin-walled, plain conical cup (Fig. 2a), with rim diameters ranging from 8 to 8.5 cm and heights from 3.5 to 4 cm. The plain or monochrome, handleless, semiglobular cup (Fig. 2b) continues the LM IA tradition.¹⁷ The handleless, concave-convex (i.e., ogival) cup with a pronounced everted rim is almost exclusively decorated with reeds (Fig. 2c), also following the LM IA tradition.¹⁸ Several examples of this cup type are present in the deposit, and it is worth noting that the reeds conform to the earlier LM IA style, with the leaves springing from a main stem and ending in fine points. This motif, usually in clusters of two or three stems, covers the entire body surface. An additional group of one-handled cups with ring bases is also decorated with reeds, but these leaves taper to rounded ends, foreshadowing the style of the next period (Fig. 2d). Clusters of reeds are also used to decorate the beaked jugs.

Another popular LM IB shape is the deep cup decorated with plain scale pattern or scale pattern filled with dots (Fig. 2f).¹⁹

Several vases belong to the Special Palatial Tradition. These include a small cup with metallic profile decorated with papyri and shields (Fig. 2e), a beaked jug with argonauts and seaweeds (Fig. 2g), several sherds decorated with pendent festoons, and

¹⁵ Banou 1996, 630–2.

¹⁶ Banou 1996, fig. 8.

¹⁷ Popham 1984, fig. 144, nos. 21 and 17.

¹⁸ Popham 1984, fig. 143, no. 6, pl. 133d.

¹⁹ Mountjoy 2003, fig. 4.22, no. 349.

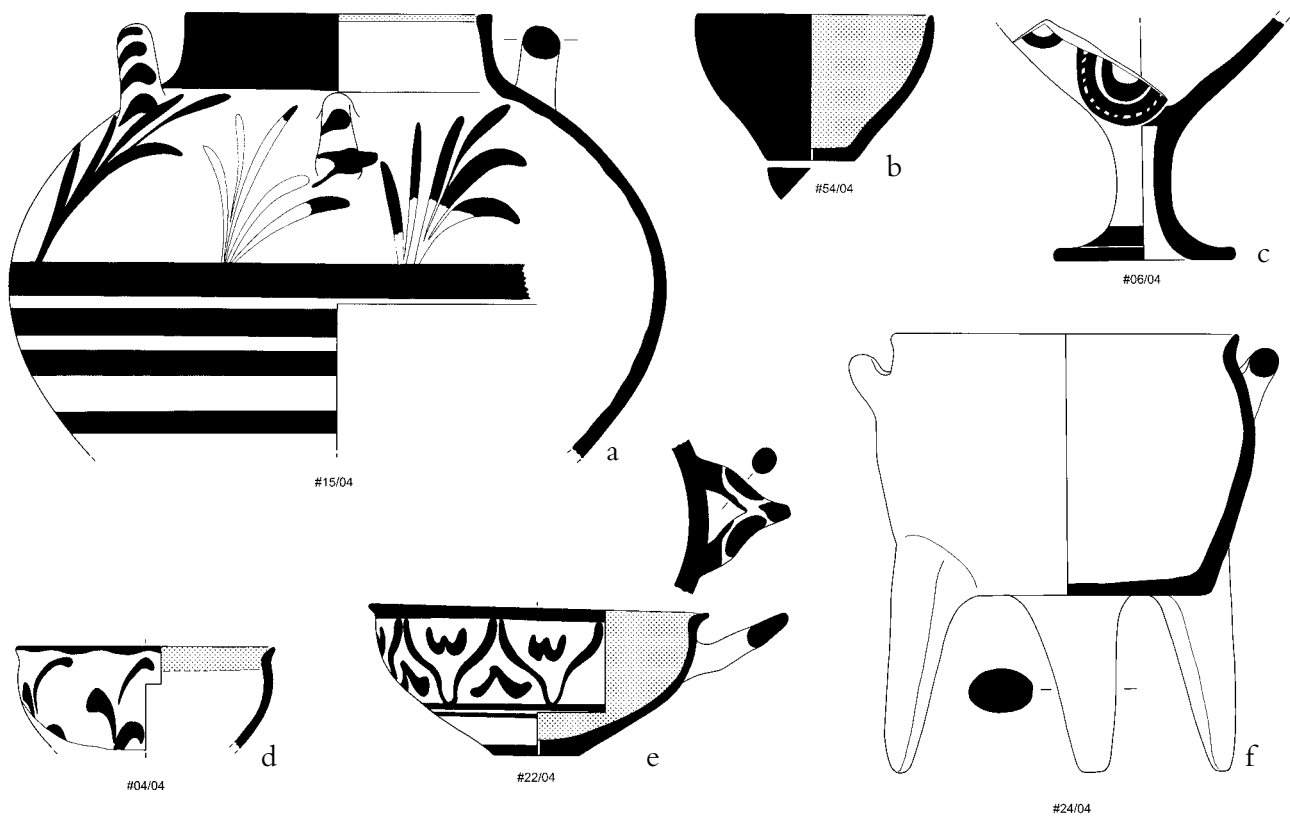

Fig. 4. Vessels that foreshadow LM II from Poros, Herakleion.

a large sherd decorated with pendants and festoons in the Abstract Style (Fig. 3).

All of these vases have parallels in the stratified LM IB deposits from Kythera (particularly deposits ξ and ν),²⁰ Archanes,²¹ Pseira,²² and from the unstratified LM IB deposits in the South House at Knossos.²³

Features foreshadowing the LM II style

Several aspects of the Liouni ceramics, including the fabric, shapes and decoration, appear to surpass the typical LM IB style and foreshadow the following LM II style.

Fabric

A soft, greenish fine fabric (perhaps a new fabric or technology) is present in the deposit. This fabric has been observed by several scholars working on LM IB-LM II material in Central Crete. One ex-

ample from the Liouni deposit consists of a wide-collared jug decorated with clusters of reeds (Fig. 4a). Popham also noted “green to yellow soft ware present in LM IB and LM II,” and this jug shape is found in the LM II deposits at MUM and at Kommos.²⁴ Low, thin kylix stems made of this soft green clay are also present in the Liouni deposit.

Shapes

The deep monochrome one-handled cup with roll handle and pulled rim is represented by a considerable number of examples in this deposit (Fig. 4b), and the shape finds identical parallels from the MUM at Knossos.²⁵ The appearance of a goblet in

²⁰ Coldstream & Huxley 1972, pl. 39, no. 103–4, pl. 40, no. 149.

²¹ Sakellarakis & Sakellarakis 1997, 420.

²² Betancourt & Davaras 1999, fig. 8BE 7.

²³ Mountjoy 2003, fig. 4.22, no. 346.

²⁴ For Knossos, see Popham 1984, 62, and 180; for Kommos, see Watrous 1992.

²⁵ Popham 1984, pl. 81.

soft greenish clay with fugitive paint (decoration of pendent loops?) is a new feature, which again belongs to the LM II style (Fig. 4c). The stems from several small kylikes were also collected from this deposit. The presence of a complete bowl with a wishbone handle, decorated with a tri-curved arch motif (Fig. 4e), recalls a similar bowl from an LM IB tomb from Poros and another from the LM II MUM deposits.²⁶

Decoration

On a few cups and bowls, the leaves of the reed motif are painted with thick brush strokes (Fig. 4d). This style of reed appears to be very popular in the LM II levels at Knossos and Kommos.²⁷ Other motifs, such as the “papyri and shield motif”, are found in deposits traditionally dated to LM IB, but they appear to express a new military ethos that could easily be assigned to LM II, foreshadowing the new LM II pictorial style. Other motifs include scale pattern, dotted scale pattern, and running spiral.

Tempered fabric-red coarse fabric

Shapes in these fabrics are difficult to date with precision and are usually dated by their context. The few vessels in tempered fabric found in this deposit include an undecorated conical basin and a large base, perhaps from a large open shape like a basin, decorated with thick undulating lines on the interior.

Several fragments of the red coarse fabric belong to Type B cooking pots, including one complete vessel (Fig. 4f) which has an identical parallel from the LM II MUM deposits. Here the body to leg ratio is 1 to 1.

Non-Minoan fabric

A nearly complete Canaanite jar was found in the upper part of the Liouni deposit (Fig. 5). This vessel retains the typical features of the Canaanite jars from the early part of the Late Bronze Age with an ovoid body and rounded shoulder.²⁸ A close parallel for our example was uncovered at Akrotiri by Mar-

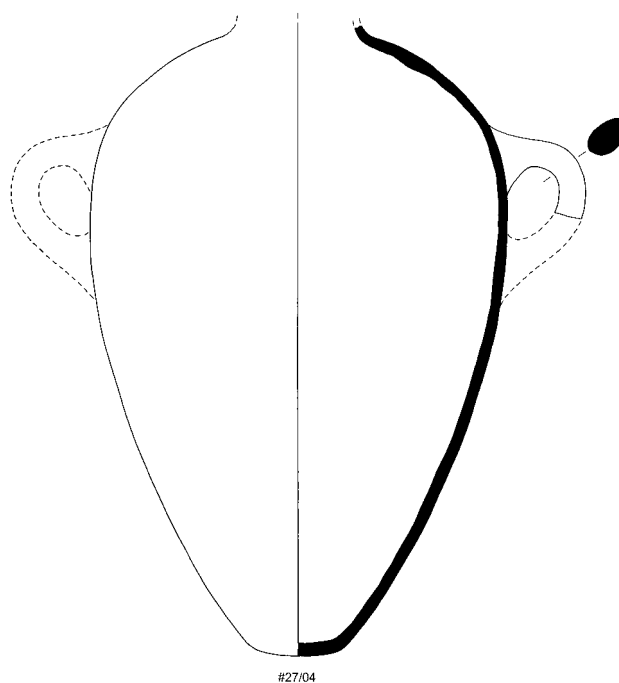

Fig. 5. Canaanite jar from Poros, Herakleion.

inatos in an LM IA context;²⁹ however, the vessel from Poros represents the earliest extant complete jar of this type from Crete (in subsequent periods, particularly in LM IIIA, many Canaanite jars are known from Kommos). Its presence at Poros should not, however, come as a surprise given the fact that Poros was the most important Minoan harbor on the north coast.³⁰

Conclusions

The LM IB deposit from the Liouni Plot contained no pottery that can be dated earlier than LM IB; in fact, the pottery is noteworthy for its mixture of elements from both LM IB and LM II styles, and it appears to be contemporary with the “LM IB” deposit from the South Corridor in the MUM. The

²⁶ For Poros, see Dimopoulou-Rethemiotaki 2004, 372, fig. 31, no. 16; for MUM, see Popham 1984, pl. 51.

²⁷ For Knossos, see Popham 1984, pl. 90c-d; for Kommos, see Watrous 1992.

²⁸ Amiran 1969–70, 140; Raban 1980.

²⁹ Marinatos 1976, 30, pl. 49b.

³⁰ Dimopoulou-Rethemiotaki 2004, 363–80.

excavator of this deposit believed that the pottery “is either mixed with LM II or represents a very early stage of LM II.”³¹ Finally, the deposit contains mixed material, but it is not mixed stratigraphically with later levels.

The features which appear to be post-LM IB and are closer to the LM II style include the use of a soft, greenish porous fabric, which may thus represent a characteristic of LM IB/II transitional pottery production, and various vessel shapes. Among these transitional forms are deep monochrome or plain one-handled cups, bowls with a wishbone handle, goblets and small kylikes. No less important is the absence in the Poros deposit of deep monochrome cups with strap handles and deep monochrome bowls.

The pottery is also decorated with a mixture of LM IB and LM II motifs. The LM IB repertoire includes scale pattern, dotted scale pattern, running spiral, reed motif, Marine Style, and Abstract motifs of the SPT, while motifs like tricurved arches and pendent festoons are more easily ascribed to the subsequent LM II ceramic style. A few motifs, like the reed motif, are rendered in a more abstract manner, including reed that is painted with the thick brush strokes more commonly found in LM II. Finally, some Neopalatial motifs like the “shield and papyrus pattern” may herald or reflect or express a militaristic social class often identified with LM II at Knossos.

The most difficult question thus appears to be what should we call this deposit – late (or mature)

LM IB? LM IB/LM II transitional? or simply early LM II? Because pottery styles are like “moving sand,” they cannot be defined easily in layers of soil. One option is to allow statistical analysis to help us date deposits. Unfortunately, the study of the Poros deposit is still at an early stage and statistics have not yet been compiled for the pottery. It is apparent from our preliminary review of the material that most of the features are still LM IB in style; however, there are a few new elements that give the material a mixed, transitional character. Therefore, the term “LM IB/II” is tentatively suggested. Others may wish to call it mature or late LM IB. But if we decide to label it thusly, we should then accept the fact that certain shapes traditionally called LM II, like the Ephyraean goblet and the small kylikes, were introduced during the Neopalatial period, possibly by new arrivals (Achaean?). In fact, the Marine Style goblet from the MUM,³² when viewed in light of the Liouni evidence, also suggests that this shape was introduced while the Marine Style was still in use. In this case, the term “transition” is suitable to express a social “episode” on the island, that is, the moment of interaction and amalgamation of two cultures, the Minoan and the Mycenaean. Further research will hopefully clarify these issues.

³¹ Popham 1984, 158, pl. 124.

³² Popham 1984, pl. 124b.

Discussion

- Alberti** This method used by Eleni Banou to make a chronology for cooking wares is really interesting: I wonder if it could work also with the material from Petras. Obviously we know that coarse wares cannot be used to achieve a fine chronology, and that's why I tried to use statistics, whenever possible. Obviously, it's a small assemblage, and the study could perhaps have been more accurate if it had been larger, but, at least, when I finished my work and saw that Metaxia [Tsipopoulou] had the same results, I was quite satisfied. As far as the typological division used in this work is concerned, obviously the AB group is fundamental. Studying the pottery from Petras House II I decided to separate the so-called AB pots because they were very different from the rest of the assemblage; thus, the large bowls could not go with the small, almost cylindrical pots, so that's why I tried to separate them and to make another sub-class.
- Cunningham** We do have at least one spouted basin in our Period XII destruction, but it's definitely the very latest of the local things that we have there. And it really is a IIIA1 piece. It's one of the ways we see just how late our Period XII destruction is. The form goes back all the way to MM III, but it's usually larger and made in a cooking pot fabric through LM IA and B, and then right at the end of Period XII it starts being made by the same local production center that makes light-slipped and burnished ware, and that's one of the markers, but we do have it in the destruction.
- Tsipopoulou** Thank you. Don't you agree that this is Palaikastro ware? Because we have a lot of pottery from Palaikastro at Petras and it is very easily recognizable.
- Cunningham** That's unmistakable, even from a photo.
- Dabney** Hi! I had a question about your evidence for the function of specialized activities in the building. Do you have any information on the faunal remains or the stone tools?
- Tsipopoulou** Yes. As I said, we have these very strange cuttings in the bedrock; they are very well-organized like drains and *gournes*, especially on the edges and corridor of Room Epsilon, and in an open area outside of the house we have larger cuttings, which we filled with water to determine how they all interconnect. Also, we had many loomweights from the upper floor, and we have several instances of the pictogram for cloth. We have the *gournes*, and especially these double *gournes*, known elsewhere only from Malia. And, yes, we had many stone tools connected with the *gournes*; additionally, the impression formed, especially at the time of excavation, was of a large amount of cooking pots, unlike in other areas, such as our House I.1, which is not exactly contemporary, but is also Neopalatial. That's why I suggested this.

- Dabney** Do you have any animal bones from the house that have been studied yet?
- Tsipopoulou** We have very few animal bones, but they have not yet been studied.
- Dabney** And the other question: were the miniature jugs and the miniature conical cups associated with each other?
- Tsipopoulou** No.
- Hemingway** We also have one of these slabs or lids like you showed, very large, at Palaikastro in an LM IB context from Building 4, also in a kind of cooking assemblage. The upper surface is very carefully finished and the underside is very rough; it doesn't seem to be a lid.
- Tsipopoulou** Maybe Lefteris [Platon] has an idea. There are three or four complete examples from Zakros in the Siteia Museum hanging on the wall. They might be like tables. But, of course, they have these suspension holes, four of them.
- Alberti** I went in June to Palaikastro and saw the cooking pots and also this strange "plate", and I noticed that its section and manufacture are exactly the same as what we call *trapezes*, but we have just fragments. Probably our *trapezes* are something like this.
- Brogan** I was fortunate enough to see Metaxia's pottery at the Study Center while Kellee [Barnard] and I were preparing our papers, and it's very clear that her ogival cups and the fragmentary pottery from this deposit match very well with the early floors at Mochlos. And so I think that this is a really important deposit for this earlier phase. How was the building abandoned? A fire destruction?
- Tsipopoulou** There was a fire destruction.
- Brogan** So it's a real destruction at the site in this period. That is an important point for the conference. And then, we also have a double *gourna* at Mochlos; it's in a mixed LM III level but probably was LM I. And, finally, it's really too bad that Eleni [Banou?] couldn't show that pottery. As Peter [Warren] said, a few of us were lucky enough to see it at the Strat. It's a very interesting mix of what looks LM IB, though looking back and having seen the full deposits you showed, we probably would look at it differently. It would also be interesting to go back because I think there were twenty levels, or twenty-one levels, and we were at the time only interested in looking at the late ones, the LM IB/II transition. But now having heard everyone's papers, it would be worth going back to the deposits and looking for earlier divisions in those as well.
- Vlazaki** Congratulations for this excellent presentation. I am thinking of the activities that were performed there and about wool dying. What about the perfume industry? I mean, do you have these miniature conical cups, do they have burned lips, or do you have others with pouring lips? Because the whole picture has something to do with the perfume industry, and there were fireboxes everywhere; it doesn't mean that we

had evidence of the perfume industry everywhere, but strainers and *gournes* are also good for this.

Tsipopoulou While I was writing this and again during this conference, I was thinking more and more of this possibility. And, I think my, if you want, *idée fixe* about the wool industry depends mostly on the pictogram of cloth. But, of course, the perfumed and special oil, as Erik [Hallager] knows, in the Linear A nodulus could be used either in the perfume industry, or to wash the wool etc., or they could have been combined. Yes, you are very right. We have this. And also the small juglets and the very small conical cups, I believe they were used to measure something, so what was this? Perfume? Oil? Dye?

Vlazaki Yes. But do you have powdered colors, have you found any?

Tsipopoulou Not in the *gournes*, I can tell you that we didn't find any. But unfortunately we didn't have the possibility at the time to do chemical analysis to see whether there were any traces.

Vlazaki For Emanuela, in Khania we have the Type 2 cooking pot with the short legs until the end of LM IB, and it is the classical type for Khania. We don't have the other one with the two vertical handles, only small ones with one vertical handle.

Alberti Yes. We have to consider the chronological dimension, but obviously Type A pots start early, as we know. And Type B pots always continue, we know that. What I cannot understand is whether the development that we see in East Crete can be applied to other parts of Crete: that's something I cannot say, but probably it is not the same.

Tsipopoulou If I may add something here, the production of cooking pots, as you all very well know, is very localized and it surprising that we find so many parallels. For instance, the cooking pots from Petras and the pots from the Achladia Villa are significantly different. They are produced by different workshops. They look generally the same but they are different, both the legs and the handles.

Doumas First of all I would like to say that large discs used as lids have been found in Akrotiri *in situ*, so these can also be lids. I was impressed that tripod cooking pots were stored in the upper story, which is very strange. But one has to bear in mind that quite often vessels were kept high on shelves even in the ground floor; we have evidence from Akrotiri about that. But, I was not impressed by the number of cooking pots, because in Akrotiri they are counted in the hundreds in every house. But I was impressed by the variety of types, which, I think, may indicate a variety of functions: cooking, boiling, stewing, making herbal teas, boiling water for the extraction of oil, dyeing, and so on. There are many possible functions, and I think this variety is more impressive than anything else.

Warren Two very brief comments. First of all as to the function of these (I'm not quite sure what you call them but we have tended to call them baking plates) very, very thin

huge dishes, they go way back in the Cretan tradition, that is, as far back as the Early Minoan IIB destruction at Phournou Koriphi. We actually had one or two of these things *in situ*, albeit broken, and, of course they were set on the ground and they had indications of fire underneath them, so, they really were used for some heating purpose, and the thin fabric would have supported that. But then, one brief question, following a little from what Christos has just said. I too found it a little surprising that all these pots, or at least many of them, were on the upper story. You said that there was collapse associated with heat or fire; is it now possible that you think the building was destroyed in a fire? But the notion of having pots involved with some sort of heating and fire on an upper floor is not easy to understand really, you would expect these kinds of fire operations to be on a ground floor.

Tsipopoulou There were lots of cooking pots, complete and broken on the floor and by the central hearth that we have there. But others came from the upper floor. Maybe they were stored there. The stratigraphy was not so difficult, because we don't have other periods in this house. So, yes there were some from the upper floor but there was sizeable activity going on there and many broken pots were found in the fire, as well as conical cups.

Betancourt On the same subject, at Pseira the kitchens were routinely on the upper story, and cooking pots were stored there as well, and there may be a simple explanation for this: it is easier to get the smoke out from the upper story than from the ground floor, if you have a multi-story building.

Sackett I think that what you'll be seeing shortly from Palaikastro is the case of grills actually fallen from either the roof or the upper floor into more than one room; it's absolutely secure, they certainly were not on shelves.

Platon On the chronology. I do not agree with the view expressed by Eleni Banou that the pottery is LM IB Early, because of the presence of the ogival type cups with light-on-dark decoration, which have also been found in Mochlos and Zakros in the latest Neopalatial level.

Tsipopoulou So, I think one of the conclusions of this conference will be that all of these destructions are contemporary, they happened on the same day!

E. Hallager That remains to be seen after the final discussion. Thank you very much and now we will proceed to Palaikastro and I would like to ask Hugh to say a few words before.

Sackett I would just like to say that this report is by MacGillivray *et al.* There is a lot of *et al.* here, four or five very senior people who have actually worked at Palaikastro and three or four now present. Sandy MacGillivray himself just was released from the hospital the evening before this conference and is not, I think, here, we weren't sure if he was going to come. But, I would say that I have once or twice given a report with him and someone felt inclined to say, "Why the two of you?" And I would answer that I am going to give some facts and Sandy is the ideas man. And I think that some of the creative thinking, which he normally provides, will be covered by Seán

[Hemingway] who excavated two of the main houses and so is a very suitable person to be doing this. Eleni Hatzaki also has just finished publishing one of the important deposits, which is in proof stage at the moment.

General discussion

- E. Hallager** But the natural question would be: would they start LM IB just because of the Theran eruption?
- Van de Moortel** If we do that, we would create a discrepancy with the LC I chronology because Cherry and Davis recognized a post-Theran eruption LC I phase. And Yannis Lolos has also recognized post-Theran eruption LH I.
- Rethemiotakis** Just a small point. When in stylistic terms the LM IA period finishes, this could be a good starting point for the next period. I have heard in several papers here, an *argumentum ex silentio* about the elimination of ripple. Most scholars here agree by consensus that this motif does not occur in LM IB whatsoever.
- Niemeier** I think we had some examples; Lefteris Platon showed one.
- Platon** On this matter, I think that the people who identify LM IA Final consider that ripple is almost absent then. This is the problem, that the same is also said for the LM IB pottery. There is a little ripple in LM IB and in LM IA Final. What is the difference?
- Macdonald** Jerry Rutter just said that nobody wanted to talk about LM IB Early, but surely this is all quite simple. This is a methodological and stratigraphical matter, but, at certain sites there are divisions, stratigraphically different phases of IB, as we will see particularly at Mochlos when we come to it. Whereas in North-central Crete, none of us has been able to find a different phase or to subdivide LM IB. Therefore, those of us who have worked mostly in North-central Crete will not talk about early LM IB because we haven't got the evidence to support it. But elsewhere in Crete, particularly in the east, Mochlos, for example, has several different levels of LM IB. So that's perfectly alright on a site by site basis. And then it's up to us as this conference progresses to decide the usefulness of these divisions. Whether they are merely stratigraphic at each site, or whether they can really be defined in any useful way to help us in different parts of Crete.
- Hood** The Minoan periods in general are defined by the horizons of destruction throughout the island, and what could be better than the eruption of a great volcano? Also, it is nice to have an outside, independent as it were, umpire. The eruption of Thera does seem to me a very good point at which to draw the line, and anything above a deposit of tephra must by definition be early LM IB. Also, of course, Evans always said that the pottery designs were based on what the fresco painters had done. There is, Christos [Doumas] assures me, no Marine Style pottery from Thera. But, in harmony with the views of Evans, there is the plaster offering table with incipient Marine Style

decoration, doubtless the work of someone more regularly employed in painting wall frescoes.

Betancourt I think it's very difficult to try to define any phase on the absence of something because of the problem of heirlooms and antiques; very often the deposits have only a few vases, and if one of them happens to be an antique with a motif from the previous phase, then that is a problem. It would be much better to define something, if it must be done on the basis of motifs and shapes, on the appearance rather than the disappearance.

Doumas It seems that as pottery is continually being produced, it is logical to think that the style which we consider LM IB started within the floruit of the LM IA style. It must have started somewhere in a geographical place. And perhaps those sites which happen to be covered with volcanic ash had not yet introduced, or accepted, or adopted this new style, while others adopted it earlier and continued on a parallel path. I don't see that we have to have a clear-cut ending.

Rutter The advantage in using the Thera eruption would be, as we heard from Irene [Nikolakopoulou] earlier, that the number of imported Minoan vessels coming from, presumably, many different centers on Crete (though the majority may come from Knossos) would be somewhere in the neighborhood of 800 whole pots; this is a larger group of chronologically homogeneous material than I know of from any single Minoan site anywhere. And it would be great just to accept this, but you have to publish all of the LM IA pots from the eruption horizon and just draw a line and say "we arbitrarily call this the end of LM IA." And you would then have the advantage of including not only Knossos but also other production regions. We know that there is regionalism in Crete already in LM IA, but that would be built into this mechanism because you would have these pots represented at Akrotiri. Otherwise, it's hard for me to imagine, and I represent a site where we have no destructions; so, if you have to find a great destruction in order to define a phase, well you can just leave Kommos out of the argument altogether. I don't think that's the way to proceed. And I agree with Phil [Betancourt] about the survival problems of ripple.

Brogan Mochlos provides the flip side of this observation. Several of our Neopalatial buildings are completely rebuilt in what we believe is a post-eruption horizon; we think it happens very soon after the eruption. Kellee [Barnard] and I may have made a mistake in our paper yesterday, and that was showing you the lowest level of Room 1 in House C.7; that's the one Colin [Macdonald] picked up on right away. We were trying to show this level as a mix, a room we think was in use already before the eruption and continued in use after the eruption; it thus had this mix, perhaps one would call it half and half. That deposit confused us and we showed it to you. If we had taken that deposit out, and just showed you what we were much more confident were post-eruption levels, there would have been less confusion. And so for Mochlos to work, not from the negative (i.e. the things that are missing) but from the positive (i.e. the things that we see happening in the post-eruption horizon), we get, like Aleydis [Van de Moortel] showed today, conical cups suddenly being produced in a buff fabric with a very consistent shape. At the same time we get the ogival cup,

which I think many sites in East Crete have, in a post-eruption horizon. We may get a few strange things in the fill, but it's very clear that they are different; the ogival cups that come in with the eruption have an almost straight side, and there are very few of them. And then, I would say that we also have the advantage of considering the difference between sites that are producing pottery like Mochlos and sites that are consuming pottery like Pseira. After the eruption, the Mochlos Artisans' Quarter begins, but Mochlos was probably producing its own pottery earlier in the MM III – LM IA horizon as well. Thus we have the advantage of seeing the impact of a major new production center introduced right after the eruption. And we see its impact on many shapes. It wasn't something that we emphasized heavily in the paper. But, there again you have the potential emphasis of a local production center starting new things, you see new ideas, new shapes, and we would argue, some new decoration. So, there is something to be said on the positive side.

Van de Moortel Just a small addition to this, the advantage of doing it this way is that the new elements that come in after the Thera destruction continue into the phase in which we have Marine Style and Special Palatial Tradition, so that is an argument to say that we see LM IB at that point. At least in East Crete.

Warren I think that Jerry [Rutter] has begun to get us into some of the fundamentals of the discussion. I am beginning to feel that in some ways we have to hold certain things in what we might call "creative tension." We will always have a situation where we have bodies of material that are stylistically consistent, which we'll say: it's reasonable to call that LM IA. And we will have other bodies of material, which, for the reasons that are already clear, with the Special Palatial Tradition and so on, we will call LM IB. And therefore we accept that after all we are talking about a passage of time, though perhaps not yet the absolute number of years, in which there are ceramic styles coming and going and developing; it may simply be meaningless to say some sharp line can be drawn between these. But, nonetheless, we can hold that in a kind of tension with the fact that we can isolate deposits here and there, as Jerry [Rutter] began to touch on; I would agree with Sinclair's [Hood] point that you could perhaps take major horizons of destruction, but that's a natural phenomenon and it's quite by chance whether it might or might not affect ceramic styles. You could have a major horizon and you could say "right, we will call it that". At first sight, the Thera eruption is a tremendous major horizon. But, as we all know, it is not easily traceable all over the island of Crete. It may be clear in some places but it's absolutely invisible in others. So that outside of Thera, it is difficult to use that as a criterion. On the other hand, we do have two really substantial destruction horizons. There isn't full agreement on what label to stick on the first one I call it MM IIIB/LM IA transition, others call it MM IIIB, and still others call it early LM IA, but it does represent a horizon that you can put your finger on at many sites across the island. And the second one, of course, is the LM IB destruction horizon. Certainly, I think it's been well demonstrated in this meeting that there is some phasing within LM IB (internal phasing within sites), both of which can be called LM IB. But it's equally impressive that the evidence suggests that there is not a great time gap between these phases within LM IB. Mochlos may perhaps point a little bit the other way, but at several sites no big gap seems to be involved, so that when you move to the wider level, the gap is small and we're not

really talking about a whole different phase within LM IB that can be very clearly demonstrated. So, we have this sort of “creative tension”, where we have different ceramic groups. The problem of regionalism and conservatism is a very real one; when we study Cretan pottery over a long period, we seem to have this sort of time-lag in many phases. I’m not trying to score points here for Knossos, perhaps I have to make that clear, but there is a sort of time-lag where you have developments; we think of the MM IB/II position, where eastern Crete is perhaps lagging a bit, as new styles have begun to be advanced in the center of Crete, whereas the older styles are carrying on a little longer in the East, but in real terms they are actually contemporary. But I don’t think we should agonize too much about this. We have deposits which we can safely call LM IA, and we have huge numbers of deposits we can safely call LM IB, but perhaps we should try not to agonize over whether or not we can draw a very sharp line between them. I don’t think Thera will work because it’s a natural phenomenon that doesn’t actually apply all over Crete; if it did, that would be a different matter.

Niemeier Just as Doumas said, the problem is that we have a continuous development, and the lines we cut are conventions to define a phase, therefore, I asked this question at the beginning. Of course I agree with Colin [Macdonald] that we would need deposits to define what is LM IA. But the problem is that everyone at the conference has his own picture of the transition from LM IA to LM IB because there is not a clear distinction between what we may call mature LM IA and early LM IB; this is a floating development and therefore we have a problem, we can’t agree where to put an exact border line. But what do we then teach the students, who want to have definitions; we have these tables where we put absolute chronology, which we fortunately left out of this conference up to now, so we are aware of those problems, I think. And there is the problem of the existence of a horizon which is contemporary all over the island; others have a different view of that. So, the Knossos excavators have shown us that, without a doubt, LM IB is a single phase. The only exception is the Minoan Unexplored Mansion South Corridor deposit, but Eleni [Hatzaki] said that one deposit doesn’t make a phase, or sub-phase, and that’s the only deposit that could be considered a chronologically different phase, at the end of LM IB or between LM IB and LM II. But we have seen Khania, and I think Maria [Vlazaki] said that we will have another look at the Khania material because, unfortunately, we started with her before we had seen all of the other material from eastern Crete. I believe that you [speaking to Maria Vlazaki] argued that you have a phase later than all of the LM IB destructions.

Vlazaki Later than the material I saw from the Royal Road published in the *Kritika Chronika*, I said.

Niemeier But you argued that you have classical Marine Style, but not in the last destruction.

Vlazaki Yes, that’s what I said; I have it in the earlier destruction.

Niemeier So, if I understand your argument correctly, then you think that the destruction of Khania may be a little later than some of the other LM IB destructions with classical Marine Style.

Vlazaki As I now understand it, it looks as though we are together with the rest of Crete; only Knossos has one destruction.

Rutter Let's be fair before we say all of North-central Crete. I would say Nirou Chani, Tylissos, Knossos. Those three. And the other sites we would have to leave out.

Vlazaki We have LM IA groups of pottery from below the final destruction, below the last floor, and all of them have Marine Style. And you see also what Aleydis [Van de Moortel] said about the fine decorated material; it looks like hers. This material belongs to the earlier floor and below, but not above. It has nothing to do with the last floor. We have not found full Marine Style *in situ* in the final deposits. It doesn't mean that we might not find it in the future. We also have these vases, which are the same as one from the Royal Road excavations which could be from Khania, in deposits earlier than the final destruction. The fabric that Sinclair Hood describes looks like Khaniote. The earlier pottery is better made, at the end it is more hastily done. Of course, it only covers a short time and goes with the destruction of the Royal Road, and I put all these together, as I had some photos from the *Kritika Chronika*, in a short phase before the final one. We have Alternating Style vases, but this pottery comes from the second stage, an advanced phase. They are not locally made, they come from Knossos, I think, but we haven't yet done analysis. And we also have something different in the architecture. Repairs were being made in several rooms of House 1 when the final destruction came. The "Sevah Building" was under repair; they closed the doors and covered the clays pipes; they put a hearth on top of a door, that's why I think that this represents later activity.

Brogan Our Marine Style, like hers, is broken up; it's not in use at the time of the destruction.

Warren Right! So! Let's put the problem the other way around. Let's say we'll take Khania as the base from which, just for the purposes of the discussion, we can discuss this matter. Obviously, Maria, we fully accept that you have two stratigraphical phases, your early one and later one, both of which are LM IB. The point I am making is a purely stratigraphical one, you have two phases. What you are suggesting at the moment is that the lower, the earlier, the first of your two phases corresponds closely with the Royal Road, and that would mean also with my Stratigraphical Museum material, and that, therefore, your later material, as it were, would be later than the horizon we are talking about at Knossos. Well, the problem there is that there are perfectly good vessels, indeed the very last one, the lily cup that you showed, which are present in the Knossos destruction, that is, material from your later phase, classic pieces; Lefteris [Platon] has one in Zakros, which we saw, and we have exact parallels of classic pieces of your later phase in the Knossos material that we are talking about. So, the solution to this problem is actually very, very simple. You have two phases, Knossos has only one. The question is almost a false one: which one of your two does Knossos go with, because it's very obvious that they have to be extremely close together in time.

Vlazaki They are close together in time since we have a Marine Style amphora in the first [phase]. That's why I said it is at the end. But there are two [phases]. Something

happens after the first. And I would prefer to have the assemblage go with the example that Lefteris [Platon] showed us. It could be with your early destruction, I don't have the assemblage to see this. ... Anyway, the one from Mochlos, which is at the same stage of the Alternating Style, is not in the final destruction, it is in the middle.

E. Hallager Maria, I want to make one point, because I think that what Lefteris [Platon] pointed out to us was very important, that the Marine Style was far less than 1 % of the entire assemblage. So, even though you have excavated a lot of plots in Khania, we cannot be absolutely certain that the Marine Style will not turn up in the late phase.

Vlazaki We have not found any vase of full classic Marine Style *in situ* in the destruction. Maybe we will find it in the future, maybe a little more advanced. For the moment we have not. Just a few sherds, mainly in mixed deposits, and then we have them in the lower one.

Platon Let's see again the context in House B which we are sure belongs with the latest phase. Here we have a known cup, which is very similar to that from the Royal Road, together with ogival cups and Alternating Style pieces, as I have shown. So, I believe that the House B context dates to the latest phase, and matches very well with the Royal Road, and, of course, matches both the first and the latest phase of the Khania assemblages.

Vlazaki But these look to be the earlier stage of Alternating Style.

Mountjoy I did say this yesterday, but perhaps people didn't take it on board. I suggested that the LM IB destructions on Crete, including Kastelli, Khania and Kastri, and the abandonment on Kythera are all contemporary, and that the fact that you have a different kind of Alternating Style, an open kind, at Kastri and Kastelli, in the last phase, indicates a regional West Cretan development. That's why it's less common in Central and East Crete, but it's there, I showed some pieces, it's there in the destructions, so you can't say that it's later. There is also the matter of the everted cup, which in fact was not later, but is present in those Central Cretan destructions. At Kastri in the final IB deposit with the Alternating Style you've also got the crowded type and the open type together with classical IB; you have got Reed Style, you've got spirals with arcades, and classic Marine Style; it's contemporary, all of it. And Maria has these in her deposit. You haven't got the Marine Style, I agree with you, that's extremely curious, but you do say that what you should perhaps have is the little tiny Argonauts on the little cups. You haven't got them, but you might get them.

Cunningham I just want to make a methodological point. I don't understand why we are trying to use the Marine Style for any chronological purpose, I mean, of all the possible things you could use this seems to me by far the least trustworthy, partly because we don't really know where it's being made or where it could be copied. People will have kept this even when it's broken and in a fragmentary state. The distribution is strange and very special, so we don't know how it's being distributed or how it's being consumed; some places have it, some don't. I just don't see any reason to try to use it for any chronological purpose. And secondly, when we talk about LM II, or Knossian LM

II, I am confused as to what would mark that. Is there anything other than these Ephyraean goblets? I mean even in the deposits that Peter [Warren] was talking about, he had his sixty intrusive sherds, all kylikes, and he hadn't actually noticed if there was anything else to go along with them. I mean the normal occurrence of kylikes in an LM II deposit would be what, from one percent, ten percent? No matter what, there's thousands of other sherds that should have been LM II in that deposit. So essentially, there is no stylistic criteria for LM II, from what I've heard, or, if there is, then what is it?

Warren Actually, I am not going to accept Tim's perfectly fair challenge just yet because we haven't got to LM II in the discussion, but I did want to say a word about Marine Style. In one sense I agree with your comment about the difficulty of using Marine Style, but we might remind ourselves that we are talking about a particular form of pottery which, going right back to Sir Arthur Evans (and he was followed by Penelope [Mountjoy] in an article at the French School symposium many years ago), almost invariably is found in special contexts associated with ritual and cult. This is certainly the case in the North Building that I was illustrating at Knossos where we have plenty of Marine Style that definitely is final LM IB, but, equally due to the nature of the material, it might not appear somewhere else. The Zakros Palace has an astonishing amount, but you need to look at it room by room and see; I'm sure you will find plenty of rooms in the Zakros Palace where there is no Marine Style. But, equally, from the Zakros Palace as a whole, there is plenty. It's a very specific kind of material, so, in that sense, you can't use it as the be all and end all of defining the end of LM IB, but it does, nevertheless, have to be part of the picture of how we look at LM IB. However, its absence may not mean that we are not at the same point of time as instances where it does occur in other rooms or in other buildings.

B.P. Hallager Anyhow, for later periods it is very important when new shapes appear. I can see that there are some differences concerning shapes between LM IA and LM IB deposits. Has anyone found any flasks in LM IA? I haven't seen any presented here. Or, for that matter, the Mycenaean type squat alabastron with one handle? That also seems to appear for the first time and to be a hallmark of LM IB. There could be other shapes, like the small stirrup jars, or, for that matter, the alabastra, which are not in LM IA deposits but seem to appear in LM IB. You could go on. Shapes are very important in LM III, more important than motifs, because old motifs continue to be used on new shapes. We have many, many examples of that. One of the classic examples that we have often talked about is Mervyn Popham's famous goblet decorated with marine motifs (*BSA* 73, 1978, 181–2, fig. 1b, pl. 24). And, while some people have tried to say that it is late LM IB, this is totally impossible because it's on a new shape introduced in LM II, an LM II goblet, even Mervyn admitted that.

Cadogan From your list, Birgitta, for flasks, I can't think of any LM IA ones, but one can think of some late MM ones; therefore, I am not sure that the fact that we may not have LM IA examples matters. But I do think small stirrup jars, meaning non-transport stirrup jars, represent a very significant development in LM IB. And both the large version and that very odd small one that I showed looked as if they ought to be LM IIIB depressed!

Betancourt A light-on-dark small stirrup jar comes from Kommos in a pure MM III deposit, along with flasks.

B.P. Hallager There always has to be a beginning. When I said that the squat alabastron seems to have been introduced in LM IB deposits, there is this curious, strange forerunner in Hagia Triada, which has been dated MM IIIB (*Creta Antica* 1984, 188, fig. 289). So, of course, it has to start somewhere, but when we can see that it becomes frequent, then we will have entered another phase.

Barnard I think there is one thing that we must be careful about with phasing, and I'm feeling guilty about our Mochlos phases here, because everyone is saying "Mochlos has this, Mochlos has that". Yes, Mochlos has it, but this does not mean that the same tendencies and styles must be present everywhere. Nobody in South-central Crete is going to get an ogival cup. We will, and we won't have it in our LM IB deposits. Same thing with Marine Style. I fully agree with Peter Warren's comments on Marine Style, and Tim's as well; it is a very special type of artifact, which at so many sites is not local and thus is imported. You're not only dealing with the style and the chronology of the style, but accessibility. Are you accessing the trade route that is bringing this in to you, or not? What does it mean for social and religious preferences for things of that special nature? I think that each site must identify its own phasing and it can't be done without stratigraphy. And you can't expect them all to match up and align. The best we can do is to get the broad picture of pan-Cretan synchronisms that show tendencies across time.

Hatzaki I think that one of the major problems in trying to look at synchronisms is the fact that there are so many regional ceramic styles, so many different workshops that are producing their own things. So, it's far more easy within particular regions to look and say things are contemporary; for example, what we have been saying about North-central Crete; the Mesara region is a very tight group, at least for, let's say, table ware; Khania; East Crete. The problem is when we look at the Standard Tradition pottery, and we have ogival cups in East Crete but no production of the semiglobular cups with fancy decoration that are found in North-central Crete; that's when we start having problems and this is where we are introducing Marine Style and Alternating Style. We have to use a combination of all three different features together in order to reach synchronisms. It's not going to work only with Marine Style, or with the Standard Tradition, or Alternating Style. It must be a combination of the three, and sometimes at sites we don't have all three together, or, rather, we don't have Alternating, Marine and Standard Tradition. So, this is what I see as our main problem at the moment; we should combine features together. Also, I would like to emphasize again what Peter [Warren] said about Marine Style, it is so socially restricted that its absence on its own is not necessarily a criterion for dating something to a later phase.

Betancourt We are probably trying to do something twenty-five years too soon; that is, until we define these regional styles, we are going to have a very hard time fitting them into the same phase in another region. Maybe what we should be concentrating on is suggesting that we all try to publish our regional styles over the next few years. There

have been relatively few articles on regional styles in print, and maybe if we did that for a while it would help.

Niemeier I think that would be very important and we have seen the regional styles in these presentations, but they haven't yet been defined. Of course, everyone has to define his own regional style for his own excavation.

E. Hallager That is something you could add to your papers.

Niemeier Perhaps we should return again to the end of the period. We have now discussed Khania; the excavators of Hagia Triada, Kommos, Pseira, Mochlos and Palaikastro have all argued that they have a phase which is later than the main LM IB destruction. The question is whether we all accept this; there have also been several suggestions of how we should call this phase, including final LM IB, LM IC, LM IB2, early LM II. Sitting next to Jerry I can see that he has prepared something on this point.

Rutter I would like to start by finding out if we do in fact have a consensus on whether there are these two different horizons because it is pointless for me to continue if we don't have a consensus on that. These two horizons are, it seems to me, clearly identifiable in Central Crete. We can talk about what the problem is in East Crete later on, or how you would line them up. But, Peter [Warren], if you and I are not going to agree on the fact that we have two different horizons, we are not going to make progress. I think that Dario [Puglisi] and I are convinced that there are two different stages.

Warren For what it's worth, I have no problem at all with the fact that this has been demonstrated. Wolf [Niemeier] has just given a list of sites where there is internal evidence for phasing in LM IB. It has been very well shown; that is perhaps one of the most interesting things to come out of this workshop. We can agree on that. The question which then arises is: do we consider the latest of those phases at all of the individual sites to be more or less contemporary around the island, or are we talking about a significant period of time, which at some sites represents a later stage. I hope that we are going to move the discussion away from simply discussing ceramic typologies to some speculations about the historical interpretation of all this material. My own feeling at the moment (and I came here very ready to learn and see what people had to say) is that we seem to end with a horizon of destruction around the island, which in some sites (for example Khania) appears to be preceded by an earlier stage of disturbance in LM IB. The evidence from Zakros, Mochlos, and your [Rutter's] site of course indicates that we end with a horizon which is more or less, perhaps not exactly, contemporary with our data. So, I come back to you [Rutter] and say: are you actually proposing from the Kommos material to place something significantly in advance chronologically of what I seem to see; and as Penelope [Mountjoy] and lots of other people have said, all around the island, we seem to have more or less a contemporary, final horizon. So, do you put some sites, including your own, significantly later than that point?

Rutter I will just lay out what I see, and you tell me what you don't agree with. It seems to me that there is a major destruction of the Villa at Hagia Triada and that this is

contemporary with a destruction of the Villa at Plakes, Pitsidia; I think those are equivalent in time. And based on what I saw yesterday, I would also link them with the destruction at Makrygialos. I would put all three together with what I called in my paper LM IB Late. That is one horizon. A separate horizon is Knossos Royal Road: North, Knossos SEX North Building, Nirou Chani, Tylissos, Kolokythi Skinias, and what I was calling LM II Early in my paper. That's a separate horizon and, if you want the list of features that separate those two, I am happy to give them to you. I bet I could come up with about ten to a dozen features. And this is not Marine Style, this is not fancy, exotic stuff, this is basic stuff that, really, we should be using, that occurs on common open shapes and so on and so forth, that we can trace easily. One of the things that really impresses me about the later stage, your terminal LM IB, is that it is easily recognizable over enormous expanses of the island. So, my question to the group is: how do we articulate in a terminological fashion this distinction. Now, if you want to ignore the distinction, fine, we don't have to do any business. But, if you want to say, yes, this is a significant distinction, what can we do? It seems to me there are three options, and I think that we've heard some of them, but let me just run them by you again: 1) we can subdivide IB (IB1, IB2, IB3); 2) we can call one horizon IB and the second some kind of sub-stage of LM II, as I said in my paper; or 3) we can go with Maria [Vlazaki] and identify the later of these two stages as IC, but I suggest that we agree as a group, because if we don't, somebody is going to commit academic suicide here. I think this is important because we are defining a couple of major ceramic horizons, which do have chronological value in my estimation, and we haven't even started to talk about the interpretation. The interpretation is a whole separate ball game, as far as I'm concerned. It's the definition of these horizons and whether we agree that they exist or not, that is the key. Mochlos, the Artisans' Quarter, I think, belongs to the later of these horizons. I also think Maria's [Vlazaki] final destruction may well belong to the later horizon, I don't know, we would have to take a look into that. It seems to me that the Zakros Palace final destruction is the earlier horizon, and so what I want to suggest to you is that it's a real patchwork. Why is Zakros earlier? Because none of the features that I am calling the identifying characteristics of the later horizon show up at Zakros, and the thing that is so striking about Zakros is that so much of its material has perfect analogues at Knossos. So, where are the little cups with the loops at the rim? Where are these features that are among the latest material? Zakros would be earlier than the Knossos Royal Road destructions.

Warren I have to say that if ever two deposits looked contemporary, it's the final destruction material of the Palace at Zakros and the material we are speaking about from Knossos. I am really amazed that you want to put Zakros as an earlier LM IB horizon. And then you go the other way around, because Maria [Vlazaki] is saying exactly the opposite.

Platon I do not agree that the Zakros Palace is dated to the earlier phase. I agree with Professor Warren. I can show you what I mean. First of all, we have many of them, which are dated at Mochlos to late LM IB, the last phase, and we have also the squat alabastron, which is very late, with argonauts of Type C. And here, we have three vases from House B, belonging to the latest phase, together with a cup similar to the

Royal Road; and here we have the identical vases from the Palace destruction layer, which are, I think, proof that the Zakros Palace destruction layer is simultaneous with the House B one, which is dated to the latest phase.

Betancourt A question. Do you also have any blob cups, or any large horizontal-handled bowls with a diameter from sixteen – eighteen centimeters?

Platon No, we do not. I think it is very clear that this phase is absent from Zakros.

Barnard We are again back to this argument from silence. Just because you don't have something doesn't mean you're still not in the right period. We need to work, as Eleni [Hatzaki] said, from what we do have in common, and I have to agree with both Lefteris [Platon] and Peter [Warren] that the Royal Road is closely connected to the Zakros destruction deposits. But also, one thing I want to ask Jerry [Rutter]: Why three periods? Why A, B, C? You said you had two horizons. [Rutter responds off microphone] Oh. Okay, you're not putting three phases in LM IB. That was my confusion.

Puglisi Do you have at Zakros a whitish greenish fabric and a one-handled cup with bars or slashes on the handle?

Platon I do, but not very many examples. From House Delta Alpha I have a flask of a very soft greenish fabric.

Puglisi Do you have slashes on the handles of rounded cups or bowls, not on closed vessels?

Platon Yes, but I can't remember very well, among the thousands of fragments; I think, it does exist, it's not a strange thing.

B.P. Hallager It's not a criterion for LM II; there are several in LM IB Khania.

Puglisi And also in LM IB Late at Kommos and in LM IB contexts at Hagia Photeini and Chalara, and maybe also at Pitsidia. So, I think such characteristics may be later in LM IB. I think we have to work with contexts, not with single vases. In addition, we have handles with slashes and the whitish greenish fabric at Hagia Triada in contexts which are later than the final destruction of the Villa. So these are regional characteristics in the Mesara, the dump at Kommos confirms this. For the rest of Crete, I don't know.

Van de Moortel This is just a suggestion. Since we have such a hard time defining two really separate phases (an LM IB Late and an LM II Early or whatever), is it just possible that at the various sites certain features appeared at different stages, and the sites that we are talking about were destroyed at different moments in time between LM IB Late and LM II Early? I think that's why you don't get the real pure phases from the various sites.

Barnard You also have to look at the entire context. Yes, Mochlos in its final phase has blob cups and horizontal-handled bowls and some other strange things. We have, I think, two blob cups and maybe ten horizontal-handled-bowls. We have thousands of other

things that don't lead us into the LM II period. There is no reason not to see that any style that is going to occur later must have precursors. Things don't start from a vacuum. You're going to have traces in an earlier period of things that become standard in the later period; you can't just immediately develop a whole new style out of the blue.

Rutter It was a bad idea of mine to mention Zakros, a bad idea! I'm perfectly happy to leave Zakros out of the picture pending further information, that's fine with me. But, the question is: what are we going to call these two periods, if in fact we agree that they are different periods? And because I agree that it opens up a whole can of worms, if we talk about two ... My own preference would be to vote for IC; I don't think we want to start sub-dividing IB, if we do, then where do we begin? We haven't even agreed on how many phases we have in IB. I am happy to publish the material from Kommos as LM IC, and I'll probably never go back to Crete again for the rest of my life anyway, which is probably a good thing. But, it would be great, if I had a little company.

Warren I very much hope we shall be seeing Jerry in Crete for many, many years, but, in truth, I don't really care about what number we use. I take the point that, if you start calling things II, there is a whole lot of baggage attached to the number II in this instance, and we haven't yet even come to talk about the first moment of the arrival of Mycenaean and all of that, so, perhaps we should stay somehow or other with the number I. I don't mind, if we want to decide at this conference that the final stage of LM IB should be called LM IC, if that's the general feeling. But, what is at issue is exactly what you put in that hypothetical IC. You've accepted to withdraw your idea of putting Zakros before IC, and, we would need to see your list, because I have the feeling that quite a few people around this room would want to put things in IC that you want to put earlier, including Skinias and Makrygialos. That's what we're really talking about, what goes with what? It thus doesn't matter too much if you want to call it IC or IB Final or something like that.

Betancourt I also do not agree with putting Nerokourou in LM IC, and I think that the Zakros final phase of LM IB and the earlier phase of LM IB are both LM IB, not LM IC. I would also put the Pseira main destruction in LM IB, and I would put the later one, LM IB Final, contemporary with LM II Early, because I think it is later than the Knossos deposit that we have seen; it already has items like blob cups that are very clearly there in the Unexplored Mansion as published by Mervyn Popham. I think we have more than just two phases, I think we have identified several phases, even if we can not characterize them very carefully, or very completely.

Dabney To the earlier suggestion about having people work together to define regions, such as East, North-central and South-central, I would like to add that you should start talking about contexts, whether ceremonial or not, palatial or not, port or not, and then you might find that you really don't yet have enough material to start defining these things.

Rethemiotakis Well, after having been tired out a bit by such elaborate conversations about pottery and ceramic sequences, I feel ready to pose a fatal question to the congress: does anyone have a definitive answer, a clue about what might have caused all these destructions?

I think this is a crucial issue to be addressed, because I have the impression that such elaborate sequences with so many destructions, or sub-destructions, or whatever, in such a comparatively short period of time need a better explanation. I think that the seismic theory is not adequate to explain such events. Perhaps human agency was involved in the events we are talking about. Well, this is an open issue, which I think we must say something about. I have experience from another site, Hellenistic Lyttos, which was destroyed in a fire caused by the Knossians – once more Knossos is involved in the Pediada! Well, when I was excavating at Kastelli, Pediada, I was puzzled by the destruction sequence; the depositional history of Kastelli was very similar to what I saw at Lyttos, which was invaded and burned by the Knossians (cf. Rethemiotakis 1992–3, 34 with Rethemiotakis 1984, 53). What happened at Kastelli is unknown, of course. I realized, and this must be of some importance, that even the domestic pottery and the pithoi in the magazines were left behind in the destruction at Lyttos, as fire swept through the building. Even their contents were not removed, olive oil and cereals remained *in situ*. And also, all the other vases, domestic and fine ware, remained there trapped in the destruction debris. Exactly the same feature was observed in the destroyed building at Minoan Kastelli. So, the first event is directly related to an invasion. It is human agency – the destruction of the city, which is well described by Polybius. This is my question: can we always speak about destruction by earthquakes, such earthquakes all over the island at so many sites simultaneously, or in different periods in short time gaps?

Warren I think you're absolutely right, it really is time we moved on to major historical things, rather than an infinite discussion of pot motifs and so on. Where are we these days in scholarship? There are roughly three possibilities, aren't there, for trying to explain the LM IB destruction and whether it was a kind of staggered destruction; we discussed that fully enough. One is the earthquake, the natural agency view of things. The other is, of course, the possibility of an invasion, and, if that's so, it could only mean a Mycenaean military intervention of some kind. But there is also a third possibility: that society reached a stage of internal collapse. This was the original version years and years ago of catastrophe theory, that it is internal tensions, competition, faction and all the rest of it, which bring things to such a state that everybody starts killing everybody else and burning their settlements down. I have always felt that the natural agency view is the strongest, the earthquake view, if you like. And, if you want an example for practically the whole of the island, Ammianus Marcellinus describes the fourth century earthquake, which affected the whole of the southern Aegean, not just Crete. But, if we are going to identify earthquakes, I would say that you have to have really, really good evidence, not just burnt pots on a floor, or even a fallen wall, because they could easily result from human intervention. What you really have to have are examples of walls that have been shifted out of position. And, to be honest, almost the only example I know of is from Zominthos, where the walls have been shaken from position, though these are of course, as we've heard, probably LM IA.

E. Hallager Well, I think Peter [Warren] has summed up very well the three possibilities, and when Tom [Brogan] and I organized this conference, we were talking about whether this should also be a topic, but we thought it would be too big and it is really a topic

for a small workshop by itself. I don't want to cut off the discussion, if there is anyone else who want to make comments on what Peter said, please.

Platon Only a small comment. In Zakros we have some works activated just a few days before the final destruction. We have saws on the floors of the luxurious Hall of the Ceremonies, we also have blocks half-sawn to make some architectural members. We have some consolidation work. And these, I think, put the matter in the direction of a seismic catastrophe. And I agree with Professor Warren that it is the most possible explanation.

Betancourt A fourth possibility is that we have some of each. Some sites are destroyed in one way, and others in another. In the case of Pseira, for example, our main destruction is accompanied by buildings that are emptied of their contents and then burned, and that, to me, suggests warfare.

Cadogan Obviously the evidence from Pyrgos does not support earthquakes, as one finds destruction at the big place in the middle and not in the places around. Human wickedness is always a very strong motive, one must remember that. Going back to the earlier discussion, not to re-open things but just to leave a thought with you, there has been the same problem with what used to be called the Philia culture at the transition from the Chalcolithic to the Early Bronze Age in Cyprus. After much discussion, the present view is that, rather than trying to define it precisely, we may now call it the *Philia facies* – which allows it to float in both time and space. So, this might be a little solution.

Cunningham The final destruction at Palaikastro, as we know from the deposition, particularly of the statuette, is definitely due to human agency, which does not rule out an earthquake for other places, or even for the earlier destruction. So, there is certainly the possibility to have both. But there is absolutely no way that these fires weren't arson. We've even reconstructed the way the building was set on fire. Likewise, at Mochlos, I believe, there is a building where an ashlar wall was pulled down and the blocks pulled around the corner and down an alleyway. I think it's physically impossible for something like an earthquake to have moved those blocks there, so, definitely there is human agency, and it looks not like some kind of marauding or internal fighting but like a very well-planned, orchestrated thing done by a very major power. I mean, basically a central power coming out and taking care of business, not internal fighting.

Macdonald When Jan Driessen and I wrote *The Troubled Island*, we went through as many sites as possible detailing such things as blocked doorways, changes in circulation and similar things. But, as you know, it was ten years ago and in certain instances, we made the assumption that the original plan would have been LM IA, with the changes being made in LM IB, followed by a destruction. And it affected the way in which we interpreted the history, if you like, of Crete during that period. Obviously, if we try to rewrite that book, it will require heavy re-interpretation in light of the much more detailed stratigraphies and architectural observations that now exist. I agree totally with the idea that we may be dealing with both natural and man-made

disasters, that is certainly a possibility, and the probability of having a single Cretan-wide earthquake from one end of the island to the other is highly unlikely. It may happen once every five hundred years, or once every thousand years, but it really is unlikely. Anyway, but that's as may be. What I have been impressed by is Lefteris' observations at Zakros, of changes immediately before the destruction. The same is apparently true with Metaxia [Tsipopoulou] in her earlier LM IB destruction; before that she was thinking that things were on their last legs. This kind of observation by excavators, I think, is to be valued greatly because the person who is actually digging it up, or looking at the original notebooks, gets an idea that we can't possibly get from reading the final publication.

Brogan Mochlos is often brought up in this context because Richard Seager claims to have found human bodies inside the LM IB destruction. Seager excavated part of Block A, at least one LM IB house in Block B, and little bits of Blocks C and D. He excavated half of the site that is now exposed. In the more recent excavations, we have instances where human body parts were found in the LM IB destruction. We found part of a body in a street of Block A, and we found the head of a young woman in the basement of a house. Jeff Soles has a very different interpretation for how that head got there, so we need to keep that out (see Soles 2010). So, we have some questions. You then might say: was Richard Seager able to identify human remains? I think he probably was because Boyd had already been doing a good job identifying human remains at Gournia from the tombs. What I would note is another difference. Not only did Seager find bodies and we don't, but he found burnt destructions. In his buildings there is evidence of a major fire (i.e. Houses B and D). When you examine Richard Seager's photographs, you see the preserved marks of half timbering in the walls; we never find that. And, our buildings do not appear to have been burned. So, Seager excavates at least House D, and what he calls House B, both of which suffered major fire destructions, and that's where he finds the bodies. We don't. And so, there is some variation in how different parts of the site were destroyed. We think very strongly that it was human agency, and we describe that in *Aegean Archaeology* (Vol. 6, 2002, 95–6). Tremendous amounts of metal were left, some of which looks to have been hoarded, and we have finally started to find medium-sized knives, almost like daggers; they didn't take them with them, they were still in these hoards. It looks like a sudden event wiped out the town and then nobody went back to pick up anything from the buildings. And so, that's where we get into the argument of the gap at the site. It's a tough question as the site, like Zakros, is in full swing; they have no idea what's coming, apart from this question of the hoards. At Zakros the metal tools, the saws, axes, etc., are in use inside the houses, and we have the same thing; not all of the metal is in the hoards, twenty or thirty percent of it is found in use throughout the houses. Still there was no attempt to take the metal with them when they left the buildings, no attempt to take the stone vases, lead weights, ivory boxes, glass beads, there are all sorts of equipment that you would have expected people to have taken with them if they had had time to clear things out. So, we think the cause is human agency, unexpected and massive, wiping out the settlement.

Kanta One thing that we must keep in mind is that some of it may well have been human agency, of course, but human agency does not destroy the whole island completely,

because how are the conquerors then going to survive? What are they going to eat? Where are they going to stay? You have your battles, you subdue the inhabitants, you punish a few, you destroy a bit and you take over the rest. This is something that we must keep in mind. Also, you must keep in mind, and I noticed at Nerokourou a long time ago, and at other sites, that there was a main “political” event sometime before the final destruction, which changed the function of all these fine buildings. At Nerokourou, for example, they were storing pithoi and working in the main Minoan hall. This shows that there may have been other reasons, as said just before, a combination of reasons.

Betancourt One somewhat allied comment is that I think we could all agree that these ceramic changes had already started to occur before the destructions. That is, that they are internal Cretan developments within the ceramic tradition; they are not introduced by a putative Mycenaean invading army. I think we all would agree to separate the late LM I phases that we have suggested from the Unexplored Mansion, which is mature LM II; that is the point where we start to get the Mycenaean shapes like the Ephyraean goblet and so forth. So, what we are talking about is a transitional situation with some internal development within the LM IB pottery, but not yet the Mycenaean shapes.

Chatzi-Vallianou Yes, LM IC but not LM II.

Vlazaki The crucial point for Khania is that at the end we have the destruction of the Linear A archives, so it cannot be LM II. But I have the feeling that this last destruction came after Knossos, but maybe I am wrong, I don't know.

Hood When invasion starts, my ears go up. It is quite obvious that if there was a Mycenaean invasion, a great mass of the people survived it, and some of them may have even been quislings and joined the invaders. But, it's also clear that one aspect of that is these fashions, which I must say do seem to me a Mycenaean introduction, these Ephyraean goblets and so on, I leave it to my elders and betters like Blegen and Wace; they don't spread all over Crete, those fashions, there are large areas where they don't seem to have penetrated at all. And if you believe in invasion, there is no reason there shouldn't be some slight time lag between destructions in one part of the island and the other. You can't do that with natural causes.

Rethemiotakis Just a small remark, to state my personal opinion after the provocative question I asked. This situation reminds me very much of what is known from a much later period in Hellenistic Crete, when the two predominant cities of Crete, Knossos and Gortys, which were involved in a prolonged civil war, each captured and destroyed the allies of the other city. So, there was widespread disaster and de-population, conflagration and civil war all over Crete.

Cadogan As Giorgos was saying, of course, their primary goal would have been to take out the main buildings, and perhaps we have been doing rather too much looking at main buildings not, I agree, at Mochlos and Pseira, but in other places, or even at Gournia.

Brogan Another interesting find from Mirabello is Krzysztof Nowicki's publication of Metaxia [Tsipopoulou's] excavations at Katalimata, Monastiraki (2008). He has an intriguing phase at the site with pottery that might be late LM IB, East Cretan LM II, or maybe IIIA1; he has a hard time defining it. It's a very unusual site. I think the copper ingot also comes from this phase. You remember that the houses at Mochlos, Gournia and Pseira all have copper ingots in this period of abandonment. And so, this again, I think, points to a level of continued worry by the local population, the fact that they would flee to a place like Katalimata. And that's when they're moving to this site, during times of tension. This suggests that during LM II in Central Cretan terms, they're moving up to a site like Katalimata. It suggests that there's a real problem in the area and they're no longer able to continue living down at these coastal sites. You can see the pottery in the final publication; it's not crystal clear but I think he's on the right track.

Tsipopoulou I just thought that civil war, or an internal disturbance hypothesis would explain the lack of radical change in the material culture. And, it would also explain the change in the function of important areas from an earlier period like at Nerokourou and Petras. This is better explained by internal upheaval rather than by the arrival of Mycenaean.

Niemeier I would just like to mention again some points which already came up in the discussion of the different papers. The Special Palatial Tradition and, especially, the Marine Style we heard about also in our final discussion, that this is ceremonial pottery that comes only from very special contexts, as Penelope Mountjoy has shown. We had a question about the role of Knossos in the production and distribution of the Special Palatial Tradition. And, Sinclair Hood had the idea that they may also be diplomatic gifts to elites around the island; we had the question of whether the Special Palatial Tradition was only produced in the Palace and did this thus signify a palatial tradition. We thought up to now that the central production center was the Palace of Knossos, and we were a little embarrassed by Galatas, with its local version of the Olive Spray Painter. I still have a problem imagining traveling painters. What should be the model? So, if these were palatial workshops, then those potters and painters were employed, let us say, by the court of Knossos and there would thus be no freelance potters who could travel all around the island and paint their vases here and there. But I think we are only at the very beginning of this discussion. Perhaps we have to do more clay analysis. Is Galatas a single case, or are these individual painters? Are the Reed Painter and the Olive Spray Painter not individual painters, but did they also copy certain motifs? Did they use some kind of pattern books where certain motifs could be copied, either by individual artists, or else copied again and again by different painters? That's an open question. I remember a paper by John Cherry at the Hobart conference about the problem of the individual painter. Can we use, like Sir John Beazley, certain motifs or manners in which the motifs are executed, to distinguish individual artists; John Cherry was very skeptical about this, and denied it, and I too find it rather problematic. Because, of course, the Olive Spray Painter, if he existed, didn't paint only olive sprays for his entire life. He must also have painted other motifs. And, of course, Phil Betancourt and Penelope Mountjoy, and also myself, have tried to identify individual painters within the Marine Style, and

there you can compare the motifs. But why should the Olive Spray Painter not also have painted octopi on stirrup jars? There is no method to recognize this.

Van de Moortel About the Olive Spray Painter, actually I was thinking last night about another group of vases that the Olive Spray Painter could have produced, and those are vases that you have in Knossos, I think, and in Nirou Chani, in Kommos we have one and in Skinias: these similar teacups or rounded cups, which have a double row of very, very nicely executed spirals, small spirals (Van de Moortel 1997, 602–3, fig. 83, C9653); they have exactly the same shape as the olive spray teacups and exactly the same thicker central band and the thinner bands underneath. And, I know from the Mochlos cup that the rim is very specific, that it is slightly undercut and is actually leaf-shaped in section, so that's one of the things we can look for.

Rethemiotakis I just remembered a very similar case for the scenario of Knossos trade potters traveling all over Crete, on occasion and on demand. A few years ago, a similar event was attested by Eleni Banou and myself when we studied and published the material from Psari Phorada, Viannos (*La Crete Mycenienne* (BCH Suppl. 30), 1997, 23–57). There we had vessels which were almost exact copies of Knossian examples. Not only subjects and execution but even the fabric looked Knossian. We were uncertain whether they were Knossian imported or locally made. And besides pottery, we also had pithoi, which had exact parallels in the Knossian magazines. To our surprise, when we made clay analysis we realized that they were locally made. So, they were made, apparently, by Knossian potters and painters who traveled as far as the south coast of Crete, in the area of Viannos, in LM II and IIIA1 and not only painted vases in the Knossian manner but also chose local clays similar to Knossian so as to produce faithful copies.

Niemeier Regarding the last point, we can't discuss it here now, but we have already touched on the need to know more about regional developments and regional styles. So, I had the impression from the slides we've seen these last few days that there really are distinct regional styles. Khania and West Crete is a very special case, the Mesara, East Crete, and I think that we have to learn more about this. It's very important because, as we have seen, the Special Palatial Tradition, which connects all of Crete, represents only a very small percentage; this is just the tip of the iceberg of the pottery we have. We need more knowledge about the regional styles in order to better know and study interregional relations.

E. Hallager Again, I think the publication will be a very good starting point for this investigation.

Bibliography

- Abramovitz, K. 1980
‘Frescoes from Ayia Irini, Keos. Parts II–IV’, *Hesperia* 49, 57–85.
- Adamo, O., S. Agodi, R.M. Albanese, A.L. D’Agata, M.C. Martinelli, S. Nicotra, O. Palio, E. Procelli & L. Sapuppo 1999
‘L’Età del Bronzo e del Ferro in Sicilia’, in Cocchi Genick 1999, 475–95.
- Alexiou, S. 1967
Υστερομινωϊκοί τάφοι Λιμένος Κνωσού (Κατσαμπιά), Athens.
- Amiran R. 1969–70
Ancient pottery from the Holy Land, Jerusalem.
- Amyx, D.A. 1988
Corinthian vase painting of the Archaic period (California Studies in the History of Art 25), Berkeley.
- Amyx, D.A. & P. Lawrence 1996
Studies in Archaic Corinthian vase painting (Hesperia Supplement 28), Princeton.
- Andreadaki-Vlazaki, M. 1988
‘Υπόγειο άδυτο ή ‘δεξαμενή καθαρών’ στα Χανιά’, *AAA* 21, 56–76.
- Andreadaki-Vlazaki, M. 1987
‘Ομάδα νεοανακτορικών αγγείων απο τον Σταυρωμένο Ρεθύμνης’, in *Ειλαπίνη. Τόμος τιμητικός για τον Καθηγητή Νικόλαο Γλάτωνα*, L. Kastriaki, G. Orphanou & N. Giannadakis (eds.), Herakleion, 55–68.
- Andreadaki-Vlazaki, M. 1994–6
‘Προϊστορικός οικισμός στα Νοπήγεια Κισάμου’, *Kritiki Estia* 5, 11–45.
- Andreadaki-Vlazaki, M. 2002
‘Are we approaching the Minoan Palace of Khania?’, in Driessen, Schoep & Laffineur 2002, 157–66.
- Andreadaki-Vlazaki, M. 2005
‘Cultes et divinités dans la ville minoenne de La Canée. Quelques réflexions’, in *KPHΣ TEXNITHΣ, L’artisan cretois, Recueil d’articles en l’honneur de Jean-Claude Poursat, publié a l’occasion des 40 ans de la decouverte du Quartier Mu*, I. Bradfer-Burdet, B. Detournay & R. Laffineur (eds.), (Aegaeum 26), Liege and Austin, 17–26.
- Andreadaki-Vlazaki, M. 2009 (ed.)
Χανιά (Κυδωνία). Περιήγηση σε χώρους αρχαίας μνήμης, Χανιά.
- Andreadaki-Vlazaki, M. & L. Godart 1982
‘Une nouvelle tablette en linéaire A de la Canée’, *SMEA* 23, 51–60.
- Antona, A., U. Badas, F. Campus, T. Cossu, A. Forci, V. Leonelli, F. Lo Schiavo, D. Marras, P. Melis, M. Perra, M.G. Puddu, R. Relli, M. Sanges & A. Usai 1999
‘I criteri di nomenclatura e terminologia applicati alla definizione delle forme vascolari nuragiche dal Bronzo Medio all’Età del Ferro’, in Cocchi Genick 1999, 497–512.
- Apostolakou, S., P.P. Betancourt & T.M. Brogan 2010
‘Ανασκαφικές έρευνες στην Παχειά ‘Άμμο και τη Χρυσή Ιεράπετρας’, in *Αρχαιολογικό Έργο Κρήτης 1. Πρακτικά της 1ης Συνάντησης Ρέθυμνο, 28–30 Νοεμβρίου* 2008, M. Andrianakis & I. Tzachili (eds.), Rethymnon, 143–54.
- Apostolakou, S., T.M. Brogan & P.P. Betancourt forthcoming
‘New evidence for the production of purple dye from the Minoan settlement on Chryssi Island’, *Aegaeum*.
- Archontaki, A. forthcoming
‘Ανασυνθέτοντας τις δραστηριότητες ενός νοικοκυριού: η περίπτωση του Κτηρίου των Κογχών στο νεοανακτορικό οικισμό της Ζάκρου’, in *Πεπραγμένα του Ι’ Διεθνούς Κρητολογικού Συνεδρίου*.
- Aston, M. & T. Taylor 1998
The atlas of archaeology, New York.
- Bagella, S., A. Depalmes, M.R. Manunzu, G. Marras & S. Sebis 1999
‘Le forme vascolari del Bronzo in Sardegna’, in Cocchi Genick 1999, 513–25.
- Banou, E. 1992
Pottery groups from the west side of Area A at Pseira, Crete, Ph.D. dissertation, University of the Pennsylvania.
- Banou, E.S. 1995a
‘The pottery, Building AA’, in Betancourt & Davaras 1995, 19–21.
- Banou, E.S. 1995b
‘The pottery, Building AD North’, in Betancourt & Davaras 1995, 94–6.
- Banou, E. 1995c
‘The pottery, Building AB (Seager’s House B)’, in Betancourt & Davaras 1995, 33–40.
- Banou, E. 1996
‘ΚΓ’ Εφορεία Προϊστορικών

- και Κλασικών Αρχαιοτήτων.
Ανασκαφικές εργασίες. Πόρος.
Οικόπεδο Ι. Λιούνη', *ArchDelt* 51
B'2, 630–2.
- Banou, E.S. 1998
'The pottery, Building AC', in
Betancourt & Davaras 1998a,
13–26, 133–6.
- Banou, E. & G. Rethemiotakis
1997
'Centre and periphery: new
evidence for the relations between
Knossos and the area of Viannos
in the LM II – IIIA periods', in
Driessen & Farnoux 1997, 23–57.
- Banou, E.S. & E. Tsivilika 2006
'Provincial Middle Minoan
pottery: the case of Pera Galenoi',
in Wiener *et al.* 2006, 94–118.
- Barber, R. 1974
'Phylakopi 1911 and the history
of the later Cycladic Bronze Age',
BSA 69, 1–15.
- Barnard, K.A. 2001
*Transition, production and
standardization in Minoan ceramics:
a view from Neopalatial Mochlos*,
Ph.D. dissertation, University of
Pennsylvania.
- Barnard, K.A. 2003
'A macroscopic analysis of the
Neopalatial fabrics', in Barnard &
Brogan 2003, 3–11.
- Barnard, K.A. & T.M. Brogan
2003
*Mochlos IB. Period III. Neopalatial
settlement on the coast: the Artisans'
Quarter and the farmhouse at
Chalinomouri. The Neopalatial
pottery* (Prehistory Monographs 8),
Philadelphia.
- Barrett, J.C. & P. Halstead (eds.)
2004
The emergence of civilization revisited
(Sheffield Studies in Aegean
Archaeology 6), Oxford.
- Baurain, C. & P. Darcque 1989
'Cinq ans de fouilles au nord-est
du palais de Malia', in *Πεπραγμένα
του ΣΤ' Διεθνούς Κρητολογικού
Συνεδρίου* A1, Khania, 135–9.
- Belardelli, C., M. Bettelli, D.
Cocchi Genick, D. De Angelis, D.
Gatti, L. Incerti, M. Lo Zupone, P.
Talamo, & A.M. Tunzi Sisto 1999
'Il Bronzo Medio e Recente
nell'Italia centro-meridionale', in
Cocchi Genick 1999, 372–93.
- Bennet, J. 2008
'Now you see it; now you
don't! The disappearance of
the Linear A script on Crete',
in *The disappearance of writing
systems. Perspectives on literacy and
communication*, J. Baines, J. Bennet
& S. Houston (eds.), London and
Oakville, 1–29.
- Berg, I. 2004
'The meanings of standardisation:
conical cups in the late Bronze Age
Aegean', *Antiquity* 78, 74–85.
- Bernini, L.E. 1995
'Ceramics of the early Neo-palatial
period at Palaikastro', *BSA* 90,
55–82.
- Betancourt, P.P. 1976
'Economic implications of the
Reed Painter's vases', *TUAS* 1,
15–17.
- Betancourt, P.P. 1978
'LM IA pottery from Priniatikos
Pyrgos', in Doumas 1978b, 381–7.
- Betancourt, P.P. 1980
*Cooking vessels from Minoan
Kommos: a preliminary report*
(Occasional Paper of the Institute
of Archaeology, University of
California 7), Los Angeles.
- Betancourt, P.P. 1983
*The Cretan Collection in the
University Museum, University of
Pennsylvania Vol. I. Minoan objects
excavated from Vasilike, Pseira*,
- Sphoungaras, Priniatikos Pyrgos, and
other sites* (University Museum
Monograph 47), Philadelphia.
- Betancourt, P.P. 1984a
*East Cretan white-on-dark ware.
Studies on handmade pottery of the
Early to Middle Minoan periods*
(University Museum Monograph
51), Philadelphia.
- Betancourt, P.P. 1984b
'Ethnology and the interpretation
of the archaeological record', in
Betancourt 1984a, 158–63.
- Betancourt, P.P. 1985
The history of Minoan pottery,
Princeton.
- Betancourt, P.P. 1985
Η ιστορία της Μινωικής κεραμικής,
Athens (transl.).
- Betancourt, P.P. 1990
*Kommos II. The Final Neolithic
through Middle Minoan III pottery*,
Princeton.
- Betancourt, P.P. 1995
'Comments and conclusions,
Building AA', in Betancourt &
Davaras 1995, 23.
- Betancourt, P.P. 1999
'The pottery, Building BT', in
Betancourt & Davaras 1999,
177–83.
- Betancourt, P.P. 2001
'The household shrine in the
house of the rhyta at Pseira', in
*POTNIA. Deities and religion in the
Aegean Bronze Age. Proceedings of the
8th International Aegean Conference,
Göteborg, Göteborg University, 12–15
April 2000*, R. Laffineur & R.
Hägg (eds.), (Aegaeum 22), Liège
and Austin, 145–9.
- Betancourt, P.P. 2004
'Knossian expansion in Late
Minoan IB: the evidence of the
Spirals and Arcading Group', in

- Cadogan, Hatzaki & Vasilakis 2004, 295–8.
- Betancourt, P.P. & E. S. Banou 1999
‘The pottery, Building BQ,’ in Betancourt and Davaras 1999, 134–6.
- Betancourt, P.P. & C. Davaras (eds.) 1995
Pseira I. The Minoan buildings on the west side of Area A (University Museum Monograph 90), Philadelphia.
- Betancourt, P.P. & C. Davaras (eds.) 1998a
Pseira II. Building AC (the ‘Shrine’) and other buildings in Area A (University Museum Monograph 94), Philadelphia.
- Betancourt, P.P. & C. Davaras (eds.) 1998b
Pseira III. The plateia building (University Museum Monograph 102), by C.R. Floyd, Philadelphia.
- Betancourt, P.P. & C. Davaras (eds.) 1999
Pseira IV. Minoan buildings in Areas B, C, D, and F (University Museum Monograph 105), Philadelphia.
- Betancourt, P.P. & C. Davaras (eds.) 2001
Pseira V. The architecture of Pseira (University Museum Monograph 109), Philadelphia.
- Betancourt, P.P. & C. Davaras (eds.) 2002
Pseira VI. The Pseira cemetery 1: the cemetery survey (Prehistory Monographs 5), Philadelphia.
- Betancourt, P.P. & C. Davaras (eds.) 2003
Pseira VII. The Pseira cemetery 2: excavation of the tombs (Prehistory Monographs 6), Philadelphia.
- Betancourt, P.P. & C. Davaras (eds.) 2004
Pseira VIII. The archaeological survey of Pseira island part 1 (Prehistory Monographs 11), Philadelphia.
- Betancourt, P.P. & C. Davaras (eds.) 2005
Pseira IX. The archaeological survey of Pseira island part 2 (Prehistory Monographs 12), Philadelphia.
- Betancourt, P.P. & C. Davaras (eds.) 2009
Pseira X. The excavation of Block AF (Prehistory Monographs 28), Philadelphia.
- Betancourt, P.P., P. Goldberg, R. Hope Simpson & C.J. Vitaliano 1990
‘Excavations at Pseira: the evidence for the Thera eruption’, in Hardy & Renfrew 1990, 96–9.
- Betancourt, P.P., V. Karageorghis, R. Laffineur & W.-D. Niemeier (eds.) 1999
Meletemata. Studies in Aegean archaeology presented to Malcolm H. Wiener as he enters his 65th year (Aegaeum 20), Liège and Austin.
- Betancourt, P.P. & J.S. Silverman 1991
The Cretan Collection in the University Museum, University of Pennsylvania Vol. II. Pottery from Gournia (University Museum Monograph 72), Philadelphia.
- Bevan, A., E. Kiriati, C. Knappett, E. Kappa & S. Papachristou 2002
‘Excavation of Neopalatial deposits at Tholos (Kastri), Kythera’, *BSA* 97, 55–96.
- Blake, E. 2002
‘Spatiality past and present: an interview with Edward Soja, Los Angeles, 12 April 2001’, *Journal of Social Archaeology* 2(2), 139–58.
- Blitzer, H. 1984
‘Traditional pottery production in Kentri, Crete: workshops, materials, techniques, and trade’, in Betancourt 1984a, 143–57.
- Borgna, E. 1997
‘Kitchen-ware from LM IIIC Phaistos. Cooking traditions and ritual activities in LBA Cretan societies’, *SMEA* 39, 189–217.
- Borgna, E. 2000
‘Food preparation and ritual activity in LM IIIC Crete’, in *Πεπραγμένα του Η΄ Διεθνούς Κρητολογικού Συνεδρίου Α1*, Herakleion, 147–59.
- Bosanquet, R.C. 1901–2
‘Excavations at Palaikastro. I’, *BSA* 8, 286–316.
- Bosanquet, R.C. 1902–3
‘Excavations at Palaikastro. II’, *BSA* 9, 274–89.
- Bosanquet, R.C. & R.M. Dawkins 1923
The unpublished objects from the Palaikastro excavations 1902–1906. Part I (BSA Supplementary Paper No.1), London.
- Bosanquet, R.C., R.M. Dawkins, M.N. Tod, W.L.H. Duckworth & J.L. Myres 1902–3
‘Excavations at Palaikastro II’, *BSA* 9, 274–387.
- Boulotis, C. 1990
‘Villes et palais dans l’art égéen du IIe millénaire av. J.-C.’, in Darcque & Treuil 1990, 421–59.
- Bourriau, J.D. & K.O. Eriksson 1997
‘A Late Minoan sherd from an early 18th Dynasty context at Kom Rabi’a, Memphis’, in *Ancient Egypt, the Aegean, and the Near East. Studies in honour of Martha Rhoads Bell*, J. Phillips (ed.), San Antonio, 95–120.

- Boyd, M.J., I.K. Whitbread & J.A. MacGillivray 2006
‘Geophysical investigations at Palaikastro’, *BSA* 101, 89–134.
- Branigan, K. (ed.) 2001
Urbanism in the Aegean Bronze Age (Sheffield Studies in Aegean Archaeology 4), Sheffield.
- Brogan, T.M. 2004
‘The incised and relief lily jars from Mochlos’, in Day, Mook & Muhly 2004, 29–41.
- Brogan, T.M. & K.A. Barnard forthcoming
‘Household archaeology at Mochlos: statistical recipes from the Late Minoan I kitchen’, in Glowacki & Vogeikoff-Brogan.
- Brogan, T.M. & A.J. Koh 2008
‘Feasting at Mochlos? New evidence for wine production, storage and consumption from a Bronze Age harbor town on Crete’, in *Dais. The Aegean feast. Proceedings of the 12th International Aegean Conference, University of Melbourne, Centre for Classics and Archaeology, 25–29 March 2008*, L.A. Hitchcock, R. Laffineur & J. Crowley (eds.), (Aegaeum 29), Liège and Austin, 125–31.
- Brogan, T.M., R.A.K. Smith & J.S. Soles 2002
‘Myceneans at Mochlos? Exploring culture and identity in the Late Minoan IB to IIIA1 transition’, *Aegean Archaeology* 6, 89–118.
- Brogan, T.M. & Ch. Sofianou 2009
‘Papadiokambos: new evidence for the impact of the Theran eruption on the northeast coast of Crete’, in Warburton 2009, 117–124.
- Brogan, T.M., Ch. Sofianou, J.E. Morrison, E. Margaritis & D. Mylonas forthcoming
‘Living off the fruit of the sea House A at Papadiokampos’, in *Subsistence, economy and society in the Greek world: improving the integration of archaeology and science, International conference, Athens, 22-24 March 2010 organized by the Netherlands Institute at Athens (NIA) and the Hellenic Society of Archaeometry (EAE)*.
- Broodbank, C. 2004
‘Minoanization’, *Proceedings of the Cambridge Philosophical Society* 50, 46–81.
- Broodbank, C., E. Kiriatzi & J. Rutter 2005
‘From Pharaoh’s feet to the slave-women of Pylos? The history and cultural dynamics of Kythera in the Third Palace Period’, in *Autochthon. Papers presented to O.T.P.K. Dickinson on the occasion of his retirement, Institute of Classical Studies, University of London, 9 November 2005*, A. Dakouri-Hild & S. Sherratt (eds.), (BAR-IS 1432), Oxford, 70–96.
- Broodbank, C & E. Kiriatzi 2007
‘The first ‘Minoans’ of Kythera revisited: technology, demography, and landscape in the Prepalatial Aegean’, *AJA* 111, 241–74.
- Bruins, H.J., J.A. MacGillivray, C.E. Synolakis, C. Benjamini, J. Keller, H.J. Kisch, A. Klügel & J. Van der Plicht 2008
‘Geoarchaeological tsunami deposits at Palaikastro (Crete) and the Late Minoan IA eruption of Santorini’, *JAS* 35, 191–212.
- Burke, B. 2006
‘Textile production at Petras: the evidence from House 2’, in *Πεπραγμένα του Θ’ Διεθνούς Κρητολογικού Συνεδρίου Α1*, Herakleion, 279–95.
- Cadogan, G. 1978
‘Pyrgos, Crete, 1970–7’, *AR* 24, 70–84.
- Cadogan, G. 1979
‘Cyprus and Crete c. 2000–1400 B.C.’, in *Acts of the International Archaeological Symposium “The relations between Cyprus and Crete, ca. 2000–500 B.C.”*, V. Karageorghis (ed.), Nicosia, 63–8.
- Cadogan, G. 1984
‘Cycladic jugs at Pyrgos’, in *The prehistoric Cyclades. Contributions to a workshop on Cycladic chronology*, J.A. MacGillivray & R.L.N. Barber (eds.), Edinburgh, 162–4.
- Cadogan, G. 2009
‘Tubular stands in Neopalatial Crete’, in D’Agata & Van de Moortel 2009, 201–12.
- Cadogan, G & A. Chaniotis 2010
‘Inscriptions from Crete’, *BSA* 105, 291–304.
- Cadogan, G., E. Hatzaki & A. Vasilakis (eds.) 2004
Knossos: palace, city, state. Proceedings of the conference in Herakleion organised by the British School at Athens and the 23rd Ephoreia of Prehistoric and Classical Antiquities of Herakleion, in November 2000, for the centenary of Sir Arthur Evans’s excavations at Knossos (BSA Studies 12), London.
- Cadogan, G. & K. Kopaka 2010
‘Coping with the offshore giant: Middle Helladic interactions with Middle Minoan Crete’, in *Mesohelladika: the Greek mainland in the Middle Bronze Age*, G. Touchais et al. (ed.), (BCH Supplement 52), Paris, 847–58.
- Cameron, M.A.S. 1987
‘The ‘Palatial’ thematic system in the Knossos murals. Last notes on Knossos frescoes’ in Hägg & Marinatos 1987, 320–8.
- Cameron, C.M. 1991
‘Structure abandonment in villages’, in *Archaeological method and theory. Vol. 3*, M.B. Schiffer (ed.), Tuscon, 155–94.

- Campus, F. & V. Leonelli 2000
La tipologia della ceramica nuragica. Il materiale edito, Sassari.
- Catling, E.A., H.W. Catling & D. Smyth 1979
'Knossos 1975: Middle Minoan III and Late Minoan I houses by the Acropolis', *BSA* 74, 1–80.
- Catling, H.W. 1983
'Archaeology in Greece, 1982–83', *AR* 29, 3–62.
- Catling, H.W. 1989
'Archaeology in Greece, 1988–89', *AR* 35, 3–116.
- Catling, H.W. 1996
'Minoan and 'Minoan' pottery at the Menelaion, Sparta', in Evely, Lemos & Sherratt 1996, 70–8.
- Catling, H.W. & A. Millett 1965
'A study of the inscribed stirrup-jars from Thebes', *Archaeometry* 8, 3–85.
- Chapouthier, F. & J. Charbonneaux 1928
Fouilles exécutées à Mallia. Premier rapport (1922–1924) (ÉtCrét 1), Paris.
- Chapouthier, F. & P. Demargne 1942
Fouilles exécutées à Mallia. Troisième rapport. Exploration du palais bordures orientale et septentrionale (1927, 1928, 1931, 1932) (ÉtCrét 6), Paris.
- Chapouthier, F. & P. Demargne 1962
Fouilles exécutées à Mallia. Quatrième rapport. Exploration du palais bordure méridionale et recherches complémentaires (1929–1935 et 1946–1960) (ÉtCrét 12), Paris.
- Chapouthier, F. & R. Joly 1936
Fouilles exécutées à Mallia. Deuxième rapport. Exploration du palais (1925–1926) (ÉtCrét 4), Paris.
- Chatzi-Vallianou, D. 1987
'Πιτσιδία', *ArchDelt* 42 B'2, 548.
- Chatzi-Vallianou, D. 1988
'Πιτσιδία. Μινωική αγρόεπαυλη (θέση Πλάκειες)', *ArchDelt* 43 B'2, 531–4.
- Chatzi-Vallianou, D. 1989
'Πιτσιδία', *ArchDelt* 44 B'2, 438–41.
- Chatzi-Vallianou, D. 1990
'Πιτσιδία. Θέση Πλάκειες. Μινωική αγρόεπαυλη', *ArchDelt* 45 B'2, 417–20.
- Chatzi-Vallianou, D. 1995
'Μινωικά κεραμικά εργαστήρια. Μια εθνολογική προσέγγιση με νέα δεδομένα', in *Πεπραγμένα του Ζ' Διεθνούς Κρητολογικού Συνεδρίου* A2, Rethymnon, 1035–60.
- Chatzi-Vallianou, D. 1997a
'Κεραμική τεχνολογία στη Μινωική Κρήτη', in *Πρακτικά Α' Συνεδρίου για "Αρχαία Τεχνολογία"*, Thessaloniki, 487–503.
- Chatzi-Vallianou, D. 1997b
'Πιτσιδία', *ArchDelt* 52 B'3, 1057–63.
- Chatzi-Vallianou, D. 1998
'Πιτσιδία', *ArchDelt* 53 B'3, 920–3.
- Chatzi-Vallianou, D. 1999
'Πιτσιδία – Μινωική αγρόεπαυλη', *ArchDelt* 54 B'2, 906–10.
- Chatzi-Vallianou, D. 2002
'Επαρχία Πυργιωτίσσης. Πιτσιδία', *Kritiki Estia* 9, 326–30.
- Cherry, J.F. 1986
'Politics and palaces: some problems in Minoan state formation', in *Peer polity interaction and socio-political change*, C. Renfrew & J.F. Cherry (eds.), Cambridge, 19–45.
- Cherry, J.F. 1992
'Beazley in the Bronze Age? Reflections on attribution studies in Aegean prehistory', in Laffineur & Crowley 1992, 123–44.
- Christakis, K.S. 1996
'Craft specialization in Minoan Crete: the case for itinerant pithos makers', *Aegean Archaeology* 3, 63–74.
- Christakis, K.S. 1999a
Minoan pithoi and their significance for the household subsistence economy of Neopalatial Crete, Ph.D. dissertation, University of Bristol.
- Christakis, K.S. 1999b
'Pithoi and food storage in Neopalatial Crete: a domestic perspective', *World Archaeology* 31 (1), 1–20.
- Christakis, K.S. 2003
'Pithoi and staple storage in the South House', in Mountjoy 2003, 153–61.
- Christakis, K.S. 2004
'Palatial economy and storage in Late Bronze Age Knossos', in Cadogan, Hatzaki & Vasilakis 2004, 299–309.
- Christakis, K.S. 2005
Cretan Bronze Age pithoi. Traditions and trends in the production and consumption of storage containers in Bronze Age Crete (Prehistory Monographs 18), Philadelphia.
- Christakis, K.S. 2006
'Traditions and trends in the production and consumption of storage containers in Protopalatial and Neopalatial Crete', in Wiener *et al.* 2006, 119–37.
- Christakis, K.S. 2008
The politics of storage. Storage and sociopolitical complexity in Neopalatial Crete (Prehistory Monographs 25), Philadelphia.
- Christakis, K.S. 2011
'Redistribution and political economies in Bronze Age Crete', *AJA* 115, 197–205.

- Christakis, K.S. forthcoming
‘The implications of archaeological formation processes in the study of the domestic sector of Late Minoan IB society’, in Glowacki & Vogeikoff-Brogan.
- Christakis, K.S. & G. Rethemiotakis forthcoming
‘Identifying household activities: the case of House 2 at Galatas Padiada, Crete’, in Glowacki & Vogeikoff-Brogan.
- Chryssoulaki, S. 2000
‘Εργαστηριακές εγκαταστάσεις στην περιοχή Ζάκρου’, in *Πεπραγμένα του Η' Διεθνούς Κρητολογικού Συνεδρίου* A3, Herakleion, 581–97.
- Cocchi Genick, D. (ed.) 1999
Criteri di nomenclatura e di terminologia inerente alla definizione delle forme vascolari del Neolitico/ Eneolitico e del Bronzo/Ferro, Atti del Congresso di Lido di Camaiore, 26–29 Marzo 1998, Florence.
- Coldstream, J.N. 1978
‘Kythera and the southern Peloponnese in the LM I period’, in Doumas 1978b, 389–401.
- Coldstream, J.N. & G.L. Huxley (eds.) 1972
Kythera. Excavations and studies conducted by the University of Pennsylvania Museum and the British School at Athens, London.
- Coldstream, J.N. & G.L. Huxley 1984
‘The Minoans of Kythera’, in Hägg & Marinatos 1984, 107–12.
- Crouwel, J. H. & C. E. Morris 1995
‘Pictorial pottery of Late Minoan II–IIIA2 Early from Knossos’ *BSA* 90, 157–82.
- Cucuzza, N. 2003
‘Il volo del grifo: osservazioni sulla Haghia Triada ‘micenea’, *Creta Antica* 4, 199–272.
- Cummer, W.W. & E. Schofield 1984
Keos. Results of excavations conducted by the University of Cincinnati under the auspices of the American School of Classical Studies at Athens. Vol. III. *Ayia Irini: House A*, Mainz.
- Cunningham, T. 2001
‘Variations on a theme: divergence in settlement patterns and spatial organization in the far east of Crete during the Proto- and Neopalatial periods’, in Branigan 2001, 72–86.
- Cunningham, T. 2007
‘Havoc: the destruction of power and the power of destruction in Minoan Crete’, in *Power and architecture. Monumental public architecture in the Bronze Age Near East and Aegean. Proceedings of the international conference Power and Architecture organized by the Katholieke Universiteit Leuven, the Université Catholique de Louvain and the Westfälische Wilhelms-Universität Münster on the 21st and 22nd of November 2002*, J. Bretschneider, J. Driessen & K. Van Lerberghe (eds.), Leuven, Paris, and Dudley, MA, 23–43.
- Dabney, M.K. 1997
‘Craft product consumption as an economic indicator of site status in regional studies’, in Laffineur & Betancourt 1997, 467–71.
- D’Agata, A.L. 1989
‘Some MM IIIB/LM IA pottery from Haghia Triada’, in Laffineur 1989, 93–7.
- D’Agata, A.L. 1999
‘Dinamiche sociali, modelli culturali e indicatori etnici a Haghia Triada nel TM III. L’evidenza offerta dalla ceramica’, in *Epi pònton plazòmenoi. Simposio Italiano di Studi Egei (Roma 1998)*, V. La Rosa, D. Palermo & L. Vagnetti (eds.), Rome, 189–98.
- D’Agata, A.L. & A. Van de
- Moortel (eds.) 2009
Archaeologies of cult. Essays on ritual and cult in Crete in honor of Geraldine C. Gesell (Hesperia Supplement 42), Princeton.
- Darcque, P. & R. Treuil (eds.) 1990
L’habitat égéen préhistorique. Actes de la table ronde internationale organisée par le Centre National de la Recherche Scientifique, l’Université de Paris I et l’École française d’Athènes (Athènes, 23–25 juin 1987) (BCH Supplement 19), Paris.
- Darcque, P. & A. Van de Moortel 2009
‘Special, ritual or cultic: a case study from Malia’, in D’Agata & Van de Moortel 2009, 31–42.
- Davaras, C. 1973
‘Μακρυγιαλός Σητείας’, *ArchDelt* 28 B’2, 590–1.
- Davaras, C. 1977
‘Μακρυγιαλός Σητείας’, *ArchDelt* 32 B’2, 338–9.
- Davaras, C. 1980
‘A Minoan pottery kiln at Palaikastro’, *BSA* 75, 115–26.
- Davaras, C. 1985
‘Αρχιτεκτονικά στοιχεία της ΥΜ ΙΒ έπαυλης του Μακρυγιαλού’, in *Πεπραγμένα του Ε' Διεθνούς Κρητολογικού Συνεδρίου Α*, Herakleion, 77–92.
- Davaras, C. 1997
‘The “cult villa” at Makrygialos’, in Hägg 1997, 117–35.
- Davis, J.L. 1986
Keos. Results of excavations conducted by the University of Cincinnati under the auspices of the American School of Classical Studies at Athens. Vol V. Ayia Irini: Period V, Mainz.
- Davis, J.L. & J.F. Cherry 2007
‘The Cycladic pottery from Late

- Bronze I levels', in Renfrew 2007, 265–306.
- Davis, J.L. & D.F. Williams 1981 'Petrological examination of later Middle Bronze Age pottery from Ayia Irini, Keos', *Hesperia* 50, 291–300.
- Dawkins, R.M. 1903 'Pottery from Zakro', *JHS* 23, 248–60.
- Dawkins, R.M. 1905–6 'Excavations at Palaikastro. V', *BSA* 12, 1–8.
- Dawkins, R.M. & C.T. Currelly 1903–4 'Excavations at Palaikastro. III', *BSA* 10, 192–231.
- Dawkins, R.M., C.H. Hawes & R.C. Bosanquet 1904–5 'Excavations at Palaikastro. IV', *BSA* 11, 258–308.
- Dawkins, R.M. & J.P. Droop 1910–11 'The excavations at Phylakopi in Melos, 1911', *BSA* 17, 1–22.
- Day, L.P., M.S. Mook & J.D. Muhly (eds.) 2004 *Crete beyond the palaces: proceedings of the Crete 2000 Conference* (Prehistory Monographs 10), Philadelphia.
- Day, P.M. 1988 'The production and distribution of storage jars in Neopalatial Crete', in *Problems in Greek prehistory. Papers presented at the centenary conference of the British School of Archaeology at Athens, Manchester, April 1986*, E.B. French & K.A. Wardle (eds.), Bristol, 499–508.
- Day, P.M. 1991 *A petrographic approach to the study of pottery in Neopalatial East Crete*, Ph.D. dissertation, Cambridge University.
- Day, P.M. 1995 'Pottery production and consumption in the Sitia Bay area during the New Palace Period', in Tsipopoulou & Vagnetti 1995, 149–75.
- Day, P.M. 1997 'Ceramic exchange between towns and outlying settlements in Neopalatial East Crete', in Hägg 1997, 219–28.
- Day, P.M., L. Joyner & M. Relaki 2003 'A petrographic analysis of the Neopalatial pottery', in Barnard & Brogan 2003, 13–32.
- Day, P.M. & M. Relaki 2002 'Past factions and present fictions; palaces in the study of Minoan Crete', in Driessen, Schoep & Laffineur 2002, 217–34.
- Day, P.M., M. Relaki & E.W. Faber 2006 'Pottery making and social reproduction in the Bronze Age Mesara', in Wiener *et al.* 2006, 22–72.
- Day, P.M., M. Relaki, M., & S. Todaro 2010 'Living from pots? Ceramic perspectives on the economies of Prepalatial Crete', in Pullen 2010b, 205–29.
- Day, P.M., D.E. Wilson & E. Kiriati 1997 'Reassessing specialization in Prepalatial Cretan ceramic production', in Laffineur & Betancourt 1997, 275–89.
- Demakopoulou, K. 1993 'Argive Mycenaean pottery: evidence from the necropolis at Kokla', in Zerner, Zerner & Winder 1993, 57–75.
- Demargne, P. & H. Gallet de Santerre 1953 *Fouilles exécutées à Mallia*.
- Exploration des maisons et quartiers d'habitation (1921–1948) I* (ÉtCrét 9), Paris.
- Deshayes, J. & A. Dessenne 1959 *Fouilles exécutées à Mallia. Exploration des maisons et quartiers d'habitation (1948–1954) II* (ÉtCrét 11), Paris.
- Dewolf, Y, F. Postel, & H. Van Effenterre 1963 'Géographie préhistorique de la région de Mallia', in *Fouilles exécutées à Mallia. Étude du site (1956–1957) et exploration des nécropoles (1915–1928)*, H. Van Effenterre & M. Van Effenterre (eds.), (ÉtCrét 13), Paris, 28–53.
- Dickinson, O.T.P.K. 1974 'The definition of Late Helladic I', *BSA* 69, 109–20.
- Dickinson, O. 1994 *The Aegean Bronze Age*, Cambridge.
- Dikaios, P. 1969 *Enkomi. Excavations 1948–1958 I–III*, Mainz.
- Dimopoulou, N. 1999 'The Marine Style ewer from Poros', in Betancourt *et al.* 1999, 217–26.
- Dimopoulou, N. 2000 '119α-β. Πρόχους του «θαλάσσιου πυθμού»', in Karetsoy, Andreadaki-Vlazaki & Papadakis 2000, 142–4.
- Dimopoulou-Rethemiotaki, N. 1987 'ΚΓ' Εφορεία Προϊστορικών και Κλασικών Αρχαιοτήτων. Ανασκαφικές εργασίες. Πόρος', *ArchDelt* 42 B'2, 528–9.
- Dimopoulou-Rethemiotaki, N. 1993 'Πόρος-Κατσαμπάς', *ArchDelt* 48 B'2, 450–9.

- Dimopoulou–Rethemiotaki, N. 2004
‘Το επίγειο της Κνωσού στον Πόρο-Κατσμπά’, in Cadogan, Hatzaki & Vasilakis 2004, 363–80.
- Dimopoulou–Rethemiotaki, N. 2005
The Archaeological Museum of Herakleion, Athens.
- Di Vita, A. 1984a
‘Atti della Scuola 1981–1984’, *ASAtene* 62 (n.s. 46), 199–263.
- Di Vita, A. (ed.) 1984b
Creta Antica. Cento anni di archeologia italiana (1884–1984), Rome.
- Di Vita, A. 1986–7
‘Atti della Scuola 1986–1987’, *ASAtene* 64–5 (n.s. 48–9), 435–534.
- Doumas, C. 1978a
‘Πιθάρια με ενδείξη για το υγρό περιεχόμενο τους απο την ΥΜ ΙΑ Θήρα’, in *STELE. Τόμος εις μνήμην Νικολάου Κοντολέοντος*, N. Zafeiropoulos et al. (eds.), Athens, 117–24.
- Doumas, C. (ed.) 1978b
Thera and the Aegean world I. Papers presented at the Second International Scientific Congress, Santorini, Greece, August 1978, London.
- Doumas, C. 1980
‘Ανασκαφή Θήρας’, *Prakt* 1980, 289–96.
- Doumas, C. 1992
The wall-paintings of Thera, Athens.
- Doumas, C. 1999
‘Εικονιστικός πύθος απο το Ακρωτήρι Θήρας’, in *Φως κωλαδικόν. Τιμητικός τόμος στη μνήμη του Νίκου Ζαφειρόπουλου*, N.C. Stampolidis (ed.), Athens, 54–73.
- Doumas, C. & A.G. Constantinides 1990
‘Pithoi, size and symbols: some preliminary considerations on the Akrotiri evidence’, in Hardy et al. 1990, 41–3.
- Doumas, C., M. Marthari & C. Televantou 2000
Museum of prehistoric Thera. A brief guide, Athens.
- Doumas, C. & L. Papazoglou 1980
‘Santorini tephra from Rhodes’, *Nature* 287, 322–4.
- Driessen, J. 2001
‘History and hierarchy. Preliminary observations on the settlement pattern of Minoan Crete’, in Branigan 2001, 51–71.
- Driessen, J. & A. Farnoux (eds.) 1997
La Crète Mycénienne. Actes de la table ronde internationale organisée par l’École française d’Athènes 26–28 Mars 1991 (BCH Supplement 30), Paris.
- Driessen, J. & C.F. Macdonald 1997
The troubled island. Minoan Crete before and after the Santorini eruption (Aegaeum 17), Liège and Austin.
- Driessen, J. 2000
‘The New Palace period’, in *Cretan quests. British explorers, excavators and historians*, D. Huxley (ed.), London, 113–28.
- Driessen, J. 2001
‘History and hierarchy’, in Branigan 2001, 51–71.
- Driessen, J.M. and J.A. MacGillivray forthcoming
‘Swept away in LM IA’, in *Πεπραγμένα του Γ’ Διεθνούς Κρητολογικού Συνεδρίου*.
- Driessen, J., A. MacGillivray & H. Sackett (eds.) 2002
Palaikastro. A Bronze Age town of Minoan Crete, birthplace of Diktaian Zeus. A retrospective exhibit to mark the centenary of archaeological research by the British School at Athens (1902–2002), London.
- Driessen, J., J.A. MacGillivray & A.L.H. Sackett 2006
‘The Late Minoan I period at Palaikastro. New evidence for the Santorini eruption’, in *Πεπραγμένα του Θ’ Διεθνούς Κρητολογικού Συνεδρίου* A1, Herakleion, 379–87.
- Driessen, J., I. Schoep & R. Laffineur (eds.) 2002
Monuments of Minos. Rethinking the Minoan palaces. Proceedings of the International Workshop “Crete of the hundred Palaces?” held at the Université Catholique de Louvain, Louvain-la-Neuve, 14–15 December 2001 (Aegaeum 23), Liège and Austin.
- Eriksson, K.O. 2003
‘A preliminary synthesis of recent chronological observations on the relations between Cyprus and other eastern Mediterranean societies during the late Middle Bronze – Late Bronze II periods’, in *The synchronisation of civilisations in the eastern Mediterranean in the second millennium B.C. II*, M. Bietak (ed.), Vienna, 411–29.
- Eustratiou, K. 1980
‘Από την κερραμική των νεοανακτορικών χρόνων στα Χανιά’, in *Πεπραγμένα του Δ’ Διεθνούς Κρητολογικού Συνεδρίου* A2, Athens, 654–8.
- Evans, A.J. 1903–4
‘The Palace of Knossos’, *BSA* 10, 1–62.
- Evans, A.J. 1906
Essai de classification des époques de la civilisation minoenne. Resume d’un discours fait au Congrès d’Archéologie à Athènes, Londres.
- Evans, A. 1921
The Palace of Minos at Knossos, I, London.

- Evans, A. 1928
The Palace of Minos at Knossos, II, London.
- Evans, A. 1930
The Palace of Minos at Knossos, III, London.
- Evans, A. 1934
The Palace of Minos at Knossos, IV, London.
- Evans, J. 1936
Index to the Palace of Minos, London.
- Evely, R.D.G. 1999
Fresco: a passport into the past. Minoan Crete through the eyes of Mark Cameron. Athens.
- Evely, R.D.G. 2000
Minoan crafts: tools and techniques. An introduction. Vol. 2 (SIMA 92:2), Jonsered.
- Evely, D., I.S. Lemos & S. Sherratt (eds.) 1996
Minotaur and centaur. Studies in the archaeology of Crete and Euboea presented to Mervyn Popham (BAR-IS 638), Oxford.
- Filippa-Touchais, A. 2000
‘Η τριποδική χύτρα στον αιγιαλό χώρο κατά τη Μέση Χαλκοκρατία. Διάδοση και σημασία’, in *Πεπραγμένα του Η΄ Διεθνούς Κρητολογικού Συνεδρίου Α3*, Herakleion, 421–2.
- Fitton, L. 2000
‘124. Αλάβαστρο’, in Karetsoy, Andreadaki-Vlazaki & Papadakis 2000, 147.
- Floyd, C.R. 1998
Pseira III. The Plateia Building (University Monographs 102), Philadelphia.
- Floyd, C.R. 1999
‘The Minoan scoop’, in Betancourt *et al.* 1999, 249–57.
- Floyd, C.R. 2000
‘Chrysokamino. The habitation site’, in *One hundred years of American archaeological work on Crete*, J.D. Muhly (ed.), Athens, 65–9.
- Floyd, C.R. 2009
‘Pottery from Block AF’, in Betancourt & Davaras, 39–98.
- Foster, K.P. 1982
Minoan ceramic relief (SIMA 64), Göteborg.
- Furumark, A. 1941a
The Mycenaean pottery. Analysis and classification, Stockholm.
- Furumark, A. 1941b
The chronology of Mycenaean pottery, Stockholm.
- Furumark, A. 1950
‘The settlement at Ialysos and Aegean history c. 1550–1400 B.C.’, *OpArch* 6, 150–271.
- Furumark, A. 1972
Mycenaean pottery II. Chronology, Stockholm.
- Galanaki, P. & G. Rethemiotakis 1999
‘Καστέλλι’, *Κρητική Εστία* 7, 241–4.
- Georgiou, H.S. 1980
‘Minoan fireboxes: a study of form and function’, *SMEA* 21, 123–92.
- Georgiou, H. 1983
‘Minoan coarse ware and Minoan technology’, in *Minoan society. Proceedings of the Cambridge Colloquium 1981*, O. Krzyszkowska & L. Nixon (eds.), Bristol, 75–91.
- Gerondakou, E. 2000
‘Λεκανές σε σχήμα σκαφής από τη Ζάκρο’, in *Πεπραγμένα του Η΄ Διεθνούς Κρητολογικού Συνεδρίου Α1*, Herakleion, 211–22.
- Gerondakou, E. forthcoming
‘Ο χαρακτήρας ενός σημαντικού «στρωματογραφικού οριζόντα» στη μινωική εγκατάσταση της Ζάκρου’, in *Πεπραγμένα του Γ΄ Διεθνούς Κρητολογικού Συνεδρίου*.
- Gesell, G.C. 1976
‘The Minoan snake tube: a survey and catalogue’, *AJA* 80, 247–59.
- Gesell, G.C. 1999
‘Ritual kalathoi in the shrine at Kavousi’, in Betancourt *et al.* 1999, 283–8.
- Giannopoulou, M. & S. Demesticha 1998
Τσιγαλαριά: τα εργαστήρια αγγειοπλαστικής της περιοχής Μανταμάδου Λέσβου, Athens.
- Gillis, C. 1990
Minoan conical cups. Form, function and significance (SIMA 89), Göteborg.
- Glowacki, K. & N. Vogeikoff-Brogan forthcoming
Stega: the archaeology of houses and households in ancient Crete (Hesperia Supplement).
- Gosselain, O.P. 2000
‘Materialising identities: an African perspective’, *Journal of Archaeological Method and Theory* 7(3), 187–217.
- Hägg, R. (ed.) 1997
The function of the “Minoan Villa”. *Proceedings of the Eighth International Symposium at the Swedish Institute at Athens, 6–8 June 1992* (SkrAth 4°, 46), Stockholm.
- Hägg, R. & N. Marinatos (eds.) 1984
The Minoan thalassocracy. Myth and reality. Proceedings of the Third International Symposium at the Swedish Institute in Athens, 31 May – 5 June, 1982 (SkrAth 4°, 32), Stockholm.
- Hägg, R. & N. Marinatos (eds.) 1987
The function of the Minoan palaces. Proceedings of the fourth international

- symposium at the Swedish Institute in Athens, 10–16 June, 1984* (SkrAth 4°, 35), Stockholm.
- Haggis, D.C. 2000
‘Coarse ware ceramic distribution in the north isthmus of Ierapetra in the Bronze Age’, *Πεπραγμένα του Η' Διεθνούς Κρητολογικού Συνεδρίου* A1, Herakleion, 535–43.
- Haggis, D.C. 2007
‘Stylistic diversity and diacritical feasting at Protopalatial Petras: a preliminary analysis of the Lakkos deposit’, *AJA* 111, 715–75.
- Haggis, D.C. & M.S. Mook 1993
‘The Kavousi coarse ware: a Bronze Age chronology for survey in the Mirabello area, East Crete’, *AJA* 97, 265–93.
- Halbherr, F., E. Stefani & L. Banti 1977
‘Haghia Triada nel periodo tardo palaziale’, *ASAtene* 55 (n.s. 39), 7–296.
- Hallager, B.P. 1997a
‘Terminology – the Late Minoan goblet, kylix and footed cup’, in Hallager & Hallager 1997, 15–44.
- Hallager, B.P., 1997b
‘Appendix. LM III pottery shapes and their nomenclature’, in Hallager & Hallager 1997, 407–17.
- Hallager, E. 1985
The Master Impression. A clay sealing from the Greek-Swedish excavations at Kastelli, Khania (SIMA 69), Göteborg.
- Hallager, E. 1996
The Minoan roundel and other sealed documents in the Neopalatial Linear A Administration (Aegaeum 14), Liège.
- Hallager, B.P. & E. Hallager 1995
‘The Knossian bull-political propaganda in Neo-palatial Crete?’, in *Politeia: society and state in the Aegean Bronze Age. Proceedings of the 5th International Aegean Conference, University of Heidelberg, Archäologisches Institut, 10–13 April, 1994*, R. Laffineur & W.-D. Niemeier (eds.), (Aegaeum 12), Liège, 547–56.
- Hallager, E. & B.P. Hallager (eds.) 1997
Late Minoan III pottery. Chronology and terminology. Acts of a meeting held at the Danish Institute at Athens, August 12–14, 1994 (Monographs of the Danish Institute at Athens 1), Athens.
- Hallager, E. & B.P. Hallager (eds.) 2000
The Greek-Swedish excavations at the Agia Aikaterini Square, Kastelli, Khania, 1970–1987. Vol. II. The Late Minoan IIIC settlement (SkrAth 4° 47/2), Stockholm.
- Hallager, E. & B.P. Hallager (eds.) 2003
The Greek-Swedish excavations at the Agia Aikaterini Square, Kastelli, Khania, 1970–1987 and 2001. Vol. III. The Late Minoan IIIB:2 settlement (SkrAth 4° 47/3 i-ii), Stockholm.
- Hallager E. & Y. Tzedakis 1988
‘The Greek–Swedish Excavations at Kastelli, Khania I. The 1989 excavation, II. The 1990 excavation’, *AAA* 21, 15–55.
- Halstead, P. 1996
‘Pastoralism or household herding? Problems of scale and specialisation in early Greek animal husbandry’, *World Archaeology* 28, 20–42.
- Halstead, P. & J.C. Barrett (eds.) 2004
Food, cuisine and society in prehistoric Greece (Sheffield Studies in Aegean Archaeology 5), Oxford.
- Hamilakis, Y. 1996
‘Wine, oil, and the dialectics of power in Bronze Age Crete: a review of the evidence’, *OJA* 15, 1–32.
- Hamilakis, Y. 1999
‘Food technologies/technologies of the body: the social context of wine and oil production and consumption in Bronze Age Crete’, *World Archaeology* 31, 38–54.
- Hamilakis, Y. 2002
‘Factional competition in Neopalatial Crete’, in Driessen, Schoep & Laffineur 2002, 179–99.
- Hankey, V. 1987
‘The chronology of the Aegean Late Bronze Age’, in *High, middle or low? Acts of an international colloquium on absolute chronology held at the University of Gothenburg 20th–22nd August 1987, part 2*, P. Åström (ed.), Gothenburg, 39–59.
- Hardy, D.A., C.G. Doulas, J.A. Sakellarakis & P.M. Warren (eds.) 1990
Thera and the Aegean world III. Vol. 1. Archaeology. Proceedings of the Third International Congress, Santorini, Greece, 3–9 September 1989, London.
- Hardy, D.A. & A.C. Renfrew (eds.) 1990
Thera and the Aegean world III. Vol. 3. Chronology. Proceedings of the Third International Congress, Santorini, Greece, 3–9 September 1989, London.
- Hatzaki, E. M. 2005
Knossos: The Little Palace (BSA, Supplementary Volume 38), London.
- Hatzaki, E. 2007a
‘Neopalatial (MM IIIB–LM IB): KS 178, Gypsades Well (upper deposit), and SEX North House groups’, in Momigliano 2007b, 151–96.

- Hatzaki, E. 2007b
‘Final Palatial (LM II-LM IIIA2) and Postpalatial (LM IIIB-LM IIIC early): MUM South Sector, Long Corridor cists, MUM pits (8, 10–11), Makritikhos ‘kitchen’, MUM North Platform pits, and SEX southern half groups’, in Momigliano 2007b, 197–252.
- Hatzaki, E.M. 2007c
‘Well 576: the pottery deposits and ceramic sequence’, in MacGillivray, Sackett & Driessen 2007, 15–95.
- Hatzaki, E. forthcoming a
‘Pots, frescoes, textiles and people. The social life of decorated pottery at Late Bronze Age Knossos, Crete’, in *Technologies of representation*, J. Bennet (ed.), Sheffield Round Table 2008.
- Hatzaki, E. forthcoming b
‘The end of an intermezzo at Knossos: ceramic wares, deposits, and architecture in context’, in *Intermezzo: intermediacy and regeneration in Middle Minoan III Crete*, C. Knappett, C. Macdonald & E. Banou (eds), BSA Studies Series.
- Hatzaki, E. forthcoming c
‘Mortuary practices and ideology in Bronze–Early Iron Age’, in *Parallel lives: ancient island societies in Crete and Cyprus*, G. Cadogan, M. Iacovou, K. Kopaka and J. Whitley (eds), BSA Studies Series.
- Hatzaki, E. forthcoming d
‘Ceramic production and consumption at the Neopalatial settlement of Myrtos-Pyrgos’.
- Hatzaki, E., M. Prent, N. Coldstream, D. Evely, A. Livarda, 2008
‘Knossos, the Little Palace North Project, Part 1: the Early Greek periods’ BSA 103, 235–89.
- Hawes, H. Boyd, B.E. Williams, R.B. Seager & E.H. Hall 1908
Gournia, Vasiliki and other prehistoric sites on the isthmus of Hierapetra, Crete. Excavations of the Wells-Houston-Cramp Expeditions 1901, 1903, 1904, Philadelphia.
- Hazzidakis, I. 1912
‘Τύλισος Μινωική’, *ArchEph* 1912, 197–233.
- Hazzidakis, J. 1921
Tylissos a l'époque Minoenne, Paris.
- Hazzidakis, J. 1934
Les villas Minoennes de Tylissos (ÉtCrét 3), Paris.
- Hitchcock, L.A. 2000
‘Of bar stools and beehives: an interpretive dialog about a Minoan store room’, in *Πεπραγμένα του Η' Διεθνούς Κρητολογικού Συνεδρίου A1*, Herakleion, 593–606.
- Hitchcock, L.A. 2007
‘Naturalising the cultural: architectonised landscape as ideology in Minoan Crete’, in *Building communities: house, settlement and society in the Aegean and beyond* (British School at Athens Studies 15), R. Westgate, N. Fisher & J. Whitley (eds.), London, 91–7.
- JHogarth, D.G. 1900–1
‘Excavations at Zakro, Crete’, *BSA* 7, 121–49.
- Hood, M.S.F. 1956
‘Another warrior-grave at Ayios Ioannis near Knossos’, *BSA* 51, 81–99.
- Hood, M.S.F. 1961–2
‘Stratigraphic excavations at Knossos, 1957–61’, in *Πεπραγμένα του Α' Διεθνούς Κρητολογικού Συνεδρίου A*, Herakleion, 92–8.
- Hood, M.S.F. 1962a
‘Sir Arthur Evans vindicated: a remarkable discovery of Late Minoan IB vases from beside the Royal Road at Knossos’, *ILN* 240 no. 6394 [17 February], 259–61.
- Hood, M.S.F. 1962b
‘Archaeology in Greece, 1961–62’, *AR* 8, 3–31.
- Hood, M.S.F. 1962c
‘Stratigraphic excavations at Knossos, 1957–61’, *CretChron* 15–16, 92–8.
- Hood, S. 1964
‘Inscribed cup from a Late Minoan IB deposit at Knossos’, *Kadmos* 3, 111–3.
- Hood, S. 1973
‘The eruption of Thera and its effects in Crete in Late Minoan I’, in *Πεπραγμένα του Γ' Διεθνούς Κρητολογικού Συνεδρίου A*, Athens, 111–18.
- Hood, S. 1978
‘Traces of the eruption outside Thera’, in Dumas 1978b, 681–90.
- Hood, S. 1985
‘Warlike destruction in Crete c. 1450 B.C.’, in *Πεπραγμένα του Ε' Διεθνούς Κρητολογικού Συνεδρίου A*, Herakleion, 170–8.
- Hood, S. 1996
‘Back to basics with Middle Minoan IIIB’, in Evely, Lemos & Sherratt 1996, 10–16.
- Hood, S. 2005
‘Dating the Knossos frescoes’ in *Aegean wall painting: a tribute to Mark Cameron*, L. Morgan (ed.) (BSA Studies 13), London, 45–81.
- Hood, S. & D. Smyth 1981
Archaeological survey of the Knossos area (BSA Supplement 14), London.
- Housely, R.A., S.W. Manning, G. Cadogan, R.E. Jones, & R.E.M. Hedges 1999
‘Radiocarbon, calibration, and the chronology of the Late Minoan IB phase’, *JAS* 26, 159–71.

- Hutchinson, R.W. 1939–40
‘Unpublished objects from Palaikastro and Praisos’, *BSA* 40, 38–50.
- Johnson, M. 1999
Archaeological theory: an introduction, Oxford.
- Johnston, A. 2000
‘120α. Κύπελλο. 120β. Κύπελλο. 121. Κύπελλο’, in Karetsoy, Andreadaki-Vlazaki & Papadakis 2000, 144–6.
- Jones, R.E. 1993
‘Appendix: chemical analysis of some Mycenaean vases from Kokla’, in Zerner, Zerner & Winder 1993, 76–80.
- Kanta A. 1984
‘The Minoan settlement of the northern part of the district Apokoronas and Minoan Apatawa’, in *Aux origines de l’Hellénisme: La Crète et Grèce. Hommage à Henri van Effenterre présente par le Centre G. Glotz*, Paris, 9–14.
- Kanta, A. & L. Rocchetti 1989
‘La ceramica del primo edificio’, in Tzedakis & Sacconi 1989, 101–279.
- Karageorghis, V. 2002
Early Cyprus. Crossroads of the Mediterranean, Los Angeles.
- Karetsoy, A. 1975
‘Το Ιερό Κορυφής του Γιούχτα’, *Prakt* 1975, 330–42.
- Karetsoy, A., M. Andreadaki-Vlazaki & N. Papadakis (eds.) 2000
Κρήτη-Αίγυπτος. Πολιτισμικοί δεσμοί τριών χιλιετιών. Κατάλογος, Herakleion.
- Karetsoy, A., M. Andreadaki-Vlazaki & N. Papadakis (eds.) 2001
Crete-Egypt. Three thousand years of cultural links. Catalogue, Herakleion.
- Katsa-Tomara, L. 1990
‘The pottery-producing system at Akrotiri: an index of exchange and social activity’, in Hardy *et al.* 1990, 31–40.
- Kemp, B.J. & R.S. Merrillees 1980
Minoan pottery in second millennium Egypt, Mainz.
- Kenna, V.E.G. 1972
CMS 12. Nordamerika I. New York, The Metropolitan Museum of Art, Berlin.
- Knappett, C. 1997
‘Ceramic production in the Protopalatial Mallia “State”’: evidence from Quartier Mu and Myrtos Pyrgos’, in Laffineur & Betancourt 1997, 305–11.
- Knappett, C. 1999
‘Can’t live without them – producing and consuming Minoan conical cups’, in Betancourt *et al.* 1999, 415–20.
- Knappett, C. 2000
‘The production of domestic pottery from Middle Minoan II Myrtos Pyrgos’, in *Πεπραγμένα του Η’ Διεθνούς Κρητολογικού Συνεδρίου Β’*, Herakleion, 51–62.
- Knappett, C. & T.F. Cunningham 2003
‘Three Neopalatial deposits from Palaikastro, East Crete’, *BSA* 98, 107–88.
- Knappett, C.J. & T. Cunningham forthcoming
Block M at Palaikastro: the Proto- and Neopalatial town. Excavations 1986–2003 (BSA Supplement), London.
- Koehl, R.B. 1986
‘A marinescape floor from the palace at Knossos’, *AJA* 90, 407–17.
- Koehl, R.B. 1990
‘The rhyta from Akrotiri and some preliminary observations on their functions in selected contexts’, in Hardy *et al.* 1990, 350–62.
- Koehl, R.B. 2000
‘Minoan rhyta in Egypt’, in Karetsoy, Andreadaki-Vlazaki & Papadakis 2000, 94–100.
- Koehl, R.B. 2006
Aegean Bronze Age rhyta (Prehistory Monographs 19), Philadelphia.
- Kopaka, K. & L. Platon 1993
‘Ληνοί μινωικοί. Installations Minoennes de traitement des produits liquides’, *BCH* 117, 35–101.
- Kopytroff, I. 1986
‘The cultural biography of things: commodization as process’, in *The social life of things. commodities in cultural perspective*, A. Appadurai (ed.), Cambridge.
- Krzyszowska, O. 2005
Aegean seals. An introduction (BICS Supplement 85), London.
- Laffineur, R. & P.P. Betancourt (eds.) 1997
TEXNH. Craftsmen, craftswomen and craftsmanship in the Aegean Bronze Age. Proceedings of the 6th International Aegean Conference, Philadelphia, Temple University, 18–21 April 1996 (Aegaeum 16), Liège and Austin.
- Laffineur, R. & J.L. Crowley (eds.) 1992
EIKON. Aegean Bronze Age Iconography: Shaping a Methodology. 4th International Aegean Conference, University of Tasmania, Hobart, 6–9 April 1992 (Aegaeum 8), Liège and Austin.
- Lamb, W. 1936
Corpus vasorum antiquorum. Great Britain, fascicule II. Cambridge, Fitzwilliam Museum, fascicule 2, Oxford.

- LaMotta, V.M. & M.B. Schiffer 1999
‘Formation processes of house floor assemblages’, in *The archaeology of household activities*, P.M. Allison (ed.), London, 19–29.
- La Rosa, V. 1979–80
‘Haghia Triada, II: relazione preliminare sui saggi del 1978 e 1979’, *ASAtene* 57–8 (n.s. 41–2), 49–164.
- La Rosa, V. 1989a
‘Nouvelles données du bronze moyen au bronze récent à Haghia Triada’, in *Transition. Le monde égéen du bronze moyen au bronze récent. Actes de la deuxième Rencontre égéenne internationale de l’Université de Liège (18–20 avril 1988)*, R. Laffineur (ed.), (Aegaeum 3), Liège, 81–92.
- La Rosa, V. 1989b
‘Recenti acquisizioni nel settore nord dell’abitato di Haghia Triada’, in *Πεπραγμένα του ΣΤ’ Διεθνούς Κρητολογικού Συνεδρίου Α1*, Khania, 411–18.
- La Rosa, V. 1992–3
‘La c.d. Tomba degli ori e il nuovo settore nord-est dell’insediamento di Haghia Triada’, *ASAtene* 70–1 (n.s. 54–5), 121–74.
- La Rosa, V. 1995
‘Le campagne 1986–1991 e la conclusione del primo ciclo di lavori ad Haghia Triada’, in *Πεπραγμένα του Ζ’ Διεθνούς Κρητολογικού Συνεδρίου Α2*, Rethymnon, 523–43.
- La Rosa, V. 1997
‘Haghia Triada à l’époque mycénienne: l’utopie d’une ville capitale’, in Driessen & Farnoux 1977, 149–266.
- La Rosa, V. 2000
‘Preghiere fatte in casa? Altari mobili da un edificio di H. Triada’, in *Πεπραγμένα του Η’ Διεθνούς Κρητολογικού Συνεδρίου Α2*, Herakleion, 137–53.
- La Rosa, V. 2002
‘Pour une révision préliminaire du second palais de Phaistos’, in Driessen, Schoep & Laffineur 2002, 71–97.
- La Rosa, V. 2006
‘Considerazioni sull’area ad W del c.d. Bastione di Haghia Triada’, *ASAtene* 84 (Series III, 6), 819–78.
- La Rosa, V. & N. Cucuzza 2001
L’insediamento di Seli di Kamilari nel territorio di Festòs (Studi di Archeologia Cretese 1), Padova.
- La Rosa, V. & A.L. D’Agata 1984
‘Festòs’, ‘Haghia Triada’, ‘Materiali dalle Raccolte pubbliche italiane’, in Di Vita 1984b, 121–226.
- Lebessi, A. 1967
‘Ανασκαφή σπηλαιώδους τάφου εις Πόρον Ηρακλείου’, *Prakt* 1967, 195–209.
- Leonard Jr., A. 1994
An index to the Late Bronze Age Aegean pottery from Syria-Palestine (SIMA 114), Jonsered.
- Levi, D. 1959
‘La villa rurale minoica di Gortina’, *BdA* 44, 237–65.
- Levi, D. 1961–2
‘Gli scavi a Festòs negli anni 1958–1960’, *ASAtene* 39–40 (n.s. 23–4), 377–504.
- Levi, D. 1965–6
‘La conclusione degli scavi a Festòs’, *ASAtene* 43–4 (n.s. 27–8), 313–99.
- Levi, D. 1967–8
‘L’abitato di Festòs in località Chálara’, *ASAtene* 45–6 (n.s. 29–30), 55–166.
- Levi, D. 1976
Festòs e la civiltà minoica I (Incunabula Graeca 60), Rome.
- Levi, D. 1988
Festòs e la civiltà minoica II (Incunabula Graeca 77), Rome.
- Levi, D. & C. Laviosa 1979–80
‘Il forno minoico da vasaio di Haghia Triada’, *ASAtene* 57–8 (n.s. 41–2), 7–47.
- Lolos, J.G. 1985
‘*The Late Helladic I pottery of the southwestern Peloponnesos and its local characteristics*’, Ph.D. dissertation, University of London, Bedford College.
- Lolos, Y.G. 1990
‘On the Late Helladic I of Akrotiri, Thera’, in Hardy & Renfrew 1990, 51–6.
- Macdonald, C. 1990
‘Destruction and construction in the palace at Knossos: LM IA-B’, in Hardy & Renfrew 1990, 82–8.
- Macdonald, C.F. 1996
‘Notes on some Late Minoan IA contexts from the palace of Minos and its immediate vicinity’, in Evely, Lemos & Sherratt 1996, 17–26.
- Macdonald, C.F. 2001
Review of *A test of time: the volcano of Thera and the chronology and history of the Aegean and East Mediterranean in the mid-second millennium B.C.* by Stuart Manning, *AJA* 105, 527–32.
- Macdonald, C. 2004
‘Ceramic and contextual confusion in the Old and New Palace periods’, in Cadogan, Hatzaki & Vasilakis 2004, 239–51.
- Macdonald, C.F. 2005
Knossos, London.

- Macdonald, C. F. & C. Knappett 2007
Knossos: Protopalatial deposits in Early Magazine A and the South-West Houses (BSA Supplement 41), London.
- MacGillivray, J.A. 1997a
‘Late Minoan II and III pottery and chronology at Palaikastro: an introduction’, in Hallager & Hallager 1997, 193–207.
- MacGillivray, J.A. 1997b
‘The re-occupation of eastern Crete in the Late Minoan II-III A1/2 periods’, in Driessen & Farnoux 1997, 275–9.
- MacGillivray, J.A. 2000a
‘Sir Arthur Evans’s Minoans and the Egyptian Renaissance of the New Kingdom’, in *Κρήτη-Αίγυπτος. Πολιτισμικοί δεσμοί τριών χιλιετιών. Μελέτες*, A. Karetsou (ed.), Athens, 150–3.
- MacGillivray, J.A. 2000b
‘The Great Kouros in Cretan art’, in MacGillivray, Driessen & Sackett 2000, 123–30.
- MacGillivray, J.A. 2009
‘Thera, Hatshepsut and the Keftiu: crisis and response in Egypt and the Aegean in the mid-second millennium BC’, in Warburton 2009, 155–70.
- MacGillivray, J.A. & J.M. Driessen 1989
‘Excavations at Palaikastro, 1988’, *BSA* 84, 417–45.
- MacGillivray, J.A. & J.M. Driessen 1990
‘Minoan settlement at Palaikastro’, in Darcque & Treuil 1990, 395–412.
- MacGillivray, J.A., J.M. Driessen & L.H. Sackett (eds.) 2000
The Palaikastro kouros. A Minoan chryselephantine statuette and its Aegean Bronze Age context (BSA Supplement 6), London.
- MacGillivray, J.A. & L.H. Sackett 1992
‘Palaikastro’, in *The aerial atlas of ancient Crete*, J.W. Myers, E.E. Myers & G. Cadogan (eds.), Berkeley and Los Angeles, 222–31.
- MacGillivray, J.A., L.H. Sackett & J.M. Driessen 1998
‘Excavations at Palaikastro, 1994 and 1996’, *BSA* 93, 221–68.
- MacGillivray, J.A., L.H. Sackett & J.M. Driessen (eds.) 2007
Palaikastro: two Late Minoan wells (BSA Supplement 43), London.
- MacGillivray, J.A., L.H. Sackett, J. Driessen, R. Bridges & D. Smyth 1989
‘Excavations at Palaikastro, 1988’, *BSA* 84, 417–45.
- MacGillivray, J.A., L.H. Sackett, J. Driessen, A. Farnoux & D. Smyth 1991
‘Excavations at Palaikastro, 1990’, *BSA* 86, 121–47.
- MacGillivray, J.A., L.H. Sackett, J.M. Driessen & S. Hemingway 1992
‘Excavations at Palaikastro, 1991’, *BSA* 87, 121–52.
- MacGillivray, J.A., L.H. Sackett, J. Driessen, C. Macdonald & D. Smyth 1988
‘Excavations at Palaikastro, 1987’, *BSA* 83, 259–82.
- McEnroe, J.C. 2010
Architecture of Minoan Crete: constructing identity in the Aegean Bronze Age, Austin.
- Mandalaki, S. 1998
Σκηνιάς. Θέση κολοκίθι (αγρός Ε. Μπριτζολάκη - Γ. Γαλανάκη)’, *ArchDelt* 53 B’3, 849–51.
- Manning, S.W. 1999
A test of time: the volcano of Thera and the chronology and history of the Aegean and East Mediterranean in the mid-second millennium BC, Oxford.
- Manning, S.W. 2009
‘Beyond the Santorini eruption: some notes on dating the Late Minoan IB period on Crete, and implications for Cretan–Egyptian relations in the 15th century BC (and especially LM II)’ in Warburton 2009, 207–26.
- Manning, S. 2010
‘Chronology and terminology’ in *The Oxford handbook of the Bronze Age Aegean (ca. 3000–1000 BC)*, E. Cline (ed.), Oxford.
- Manning, S.W. & C.B. Ramsey 2003
‘A Late Minoan I-II absolute chronology for the Aegean – combining archaeology with radiocarbon’, in *The synchronisation of civilisations in the eastern Mediterranean in the second millennium B.C. II. Proceedings of the SCIEM 2000 – EuroConference, Haindorf, 2nd of May – 7th of May 2001*, M. Bietak (ed.), Vienna, 111–33.
- Manning, S.W., C.B. Ramsey, C. Doumas, T. Marketou, G. Cadogan & C.L. Pearson 2002
‘New evidence for an early date for the Aegean Late Bronze Age and Thera eruption’, *Antiquity* 76, 733–44.
- Manning, S.W., C.B. Ramsey, W. Kutschera, T. Higham, B. Kromer, P. Steier & E.M. Wild 2006
‘Chronology for the Aegean Late Bronze Age 1700–1400 B.C.’, *Science* 312, 565–9.
- Mannoni, T. & E. Giannichedda 1996
Archeologia della produzione, Torino.
- Mantzourani, E., G. Vavouranakis & C. Kanellopoulos 2005
‘The Klimataria-Manares building reconsidered’, *AJA* 109, 743–76.

- Marinatos, S. 1924–5
‘Μεσομινωικό οικία εν Κάτω
Μεσαρά’, *ArchDelt* 9, 53–78.
- Marinatos, S. 1925–6
‘Ανασκαφαί Νιούρου Χάνι Κρήτης’,
Prakt 1925–6, 141–7.
- Marinatos, S. 1939–41
‘Το Μινωικόν μέγαρον
Σιλαβόκαμπου’, *ArchEph* 1939–41,
69–96.
- Marinatos, S. 1969
*Excavations at Thera II (1968
season)*, Athens.
- Marinatos, S. 1971
*Excavations at Thera IV (1970
season)*, Athens.
- Marinatos, S. 1972
*Excavations at Thera V (1971
season)*, Athens.
- Marinatos, S. 1974
*Excavations at Thera VI (1972
season)*, Athens.
- Marinatos, S. 1976
Excavations at Thera VII. Athens.
- Marinatos, S. 1999a
*Excavations at Thera IV–V. 1970–
1971 seasons* (The Archeological
Society at Athens Library no. 179),
Athens.
- Marinatos, S. 1999b
*Excavations at Thera VI–VII. 1972–
1973 seasons* (The Archeological
Society at Athens Library no. 180),
Athens.
- Marinatos, S. & M. Hirmer 1960
Crete and Mycenae, London.
- Marinatos, S. & M. Hirmer 1973
*Kreta, Thera und das mykenische
Hellas*, Munich.
- Marketou, T. 1990
‘Santorini tephra from Rhodes and
Kos: some chronological remarks
based on the stratigraphy’, in
Hardy & Renfrew 1990, 100–13.
- Marketou, T. *et al.* 2006
‘Pottery wares from the prehistoric
settlement at Ialysos (Trianda) in
Rhodes’, *BSA* 106, 1–55.
- Marthari, M. 1980
‘Ακρωτήρι, κεραμεική
Μεσοελλαδικής παράδοσης
στο στρώμα της ηφαιστειακής
καταστροφής’, *AE* 1980, 182–211.
- Marthari, M. 1987
‘The local pottery wares with
painted decoration from the
volcanic destruction level of
Akrotiri, Thera. A preliminary
report’, *AA* 1987, 359–79.
- Marthari, M. 1990
‘The chronology of the last phases
of occupation at Akrotiri in the
light of the evidence from the West
House pottery groups’, in Hardy &
Renfrew 1990, 57–70.
- Marthari, M. 1993a
*Ακρωτήρι Θήρας. Η κεραμεική
του στρώματος της ηφαιστειακής
καταστροφής*, Ph.D. dissertation,
University of Athens.
- Marthari, M. 1993b
‘The ceramic evidence for contacts
between Thera and the Greek
mainland’, in Zerner, Zerner &
Winder 1993, 249–56.
- Marthari, M. 2000
‘The attraction of the pictorial:
observations on the relationship of
Theran pottery and Theran fresco
iconography’, in *Proceedings of the
First International Symposium “The
wall paintings of Thera”*, Petros M.
Nomikos Conference Centre, Thera,
Hellas, 30 August–4 September 1997,
S. Sherratt (ed.), Athens, 873–89.
- Martlew, H. 1988
‘Domestic coarse pottery in
Bronze Age Crete’, in *Problems in
Greek prehistory. Papers presented at
the centenary conference of the British
School of Archaeology at Athens,
Manchester, April 1986*, E.B. French
& K.A. Wardle (eds.), Bristol,
421–4.
- Martlew, H. 1996
‘What a difference a spout makes:
Minoan and Mycenaean cooking
vessels and what they can tell us’,
BICS 41, 144–5.
- Matthäus, H. 1980
*Die bronzegefäße der kretisch-
mykenischen kultur* (Prähistorische
Bronzefunde II: 1), Munich.
- Mavroudi, N. 2004
*Προσεργίσεις της οικιακής
αρχιτεκτονικής στην Κρήτη κατά
τη Νεοανακτορική περίοδο. Το
παράδειγμα του Σπιτιού ΙΙ στον
Πετρό*, Unpublished MA Thesis,
University of Rethymnon.
- Merrillees, R.S. & J. Evans 1980
‘An essay in provenance: the Late
Minoan IB pottery from Egypt’,
Berytus 28, 1–45.
- Merrillees, R.S. & J. Winter 1972
‘Bronze Age trade between the
Aegean and Egypt: Minoan and
Mycenaean pottery from Egypt in
the Brooklyn Museum’, *Miscellanea
Wilbouriana* 1, 101–33.
- Michaelidis, P. 1993
‘Potters’ workshops in Minoan
Crete’, *SMEA* 32, 7–39.
- Militello, P. 1989
‘Gli scribi di Hagia Triada, alcune
osservazioni’, *PP* 44, 126–47.
- Militello, P. 1992
‘Aspetti del funzionamento del
sistema amministrativo ad Hagia
Triada’, in *Mykenaika. Actes du
IXe colloque international sur les
texts mycéniens et égéens organisé par
le Centre de l’Antiquité Grecque et
Romaine de la Fondation Hellénique
des Recherches Scientifiques et l’École
française d’Athènes* (Athènes, 2–6

- octobre 1990), J.-P. Olivier (eds.), (BCH Supplement 25), Paris, 411–4.
- Militello, P. 2000
‘Organizzazione dello spazio e vita quotidiana nelle case TM I di Haghia Triada’, in *Πεπραγμένα του Η’ Διεθνούς Κρητολογικού Συνεδρίου* A2, Herakleion, 313–34.
- Moak, M. 2000
‘The Palaikastro kouros’, in MacGillivray, Driessen & Sackett 2000, 65–86.
- Molloy, B. 2008
‘Martial arts and materiality: a combat archaeology perspective on Aegean swords of the fifteenth and fourteenth centuries BC’, *World Archaeology* 40.1, 116–34.
- Molloy, B., 2010. ‘Swords and swordsmanship in the Aegean Bronze Age’ *AJA* 114, 403–28.
- Momigliano, N. 1999
Duncan Mackenzie: a cautious canny Highlander and the palace of Minos at Knossos, London.
- Momigliano, N. 2001
‘Bronze Age Carian Iasos’, *Anatolian Archaeology* 7, 15.
- Momigliano, N. 2007a
‘Kamares or not Kamares? This is [not] the question. Southeast Aegean Light-On-Dark (LOD) and Dark-On-Light (DOL) pottery: synchronisms, production centers, and distribution’, in *Middle Helladic pottery and synchronisms. Proceedings of the International Workshop held at Salzburg, October 31st–November 2nd, 2004*, F. Felten, W. Gauss & R. Smetana (eds.), Vienna, 257–72.
- Momigliano, N. (ed.) 2007b
Knossos pottery handbook. Neolithic and Bronze Age (Minoan) (BSA Studies 14), London.
- Moody, J. 1985
‘The development of a Bronze Age coarse ware chronology for the Khania region of West Crete’, *TUAS* 10, 51–65.
- Moody, J. forthcoming
‘Hinterlands and hinterseas: resources and production zones in Bronze and Iron Age Crete’, in *Parallel lives: ancient island societies in Crete and Cyprus*, G. Cadogan, K. Kopaka & M. Iacovou (eds.), (BSA Studies Series)
- Moody, J., H.L. Robinson, J. Francis, L. Nixon & L. Wilson 2003
‘Ceramic fabric analysis and survey archaeology: the Sphakia Survey’, *BSA* 98, 37–105.
- Mook, M.S. 1999
‘Cooking dishes from the Kastro’, in Betancourt *et al.* 1999, 503–9.
- Morgan, L. 1988
The miniature wall paintings of Thera: a study in Aegean culture and iconography, Cambridge.
- Morgan, L. (ed.) 2005
Aegean wall painting. A tribute to Mark Cameron (BSA Studies 13), London.
- Morricone, L. 1972–3
‘Coo – scavi e scoperte nel “serraglio” e in località minori (1935–1943)’, *ASAtene* 50–1 (n.s. 34–5), 139–396.
- Mountjoy, P.A. 1974a
‘A later development in the Late Minoan IB Marine Style’, *BSA* 69, 177–80.
- Mountjoy, P.A. 1974b
‘A note on the LM IB Marine Style at Knossos’, *BSA* 69, 173–5.
- Mountjoy, P.A. 1976a
‘Late Helladic IIIB 1 pottery dating the construction of the South House at Mycenae’, *BSA* 71, 77–111.
- Mountjoy, P.A. 1976b
‘A Late Minoan IB Marine Style rhyton from Pseira’, *AAA* 9, 83–6.
- Mountjoy, P.A. 1983
‘The Ephyraean goblet reviewed’, *BSA* 78, 265–71
- Mountjoy, P.A. 1984
‘The Marine Style pottery of LM IB/LH IIA: towards a corpus’, *BSA* 79, 161–219.
- Mountjoy, P.A. 1985
‘Ritual associations for LM IB Marine Style vases’, in *L’iconographie minoenne. Actes de la table ronde d’Athènes (21–22 avril 1983)*, P. Darceque & J.-C. Poursat (eds.), (BCH Supplement 11), Athens, 231–42.
- Mountjoy, P.A. 1986
Mycenaean decorated pottery: a guide to identification (SIMA 73), Göteborg.
- Mountjoy, P.A. 1999
Regional Mycenaean decorated pottery, Rahden/Westf.
- Mountjoy, P.A. 2003
Knossos. The South House (BSA Supplement 34), London.
- Mountjoy, P.A. 2004
‘Knossos and the Cyclades in Late Minoan IB’, in Cadogan, Hatzaki & Vasilakis 2004, 399–404.
- Mountjoy, P.A. 2007
‘The Mycenaean and Late Minoan I-II pottery’, in *Excavations at Phylakopi in Melos 1974–77*, C. Renfrew (ed.), (BSA Supplement 42), London, 307–70.
- Mountjoy, P.A. 2009
‘Some LM IB/LH IIA Marine Style pottery from Kea’, in *ΔΩΡΟΝ: Τιμητικός τόμος για*

- τον Καθηγητή Σπύρο Ιακωβίδη, D. Danielidou (ed.), Athens, 441–56.
- Mountjoy, P.A., R.E. Jones & J.F. Cherry 1978
‘Provenance studies of the LMIB/LHIIA Marine Style’, *BSA* 73, 143–71.
- Mountjoy, P.A. & M.J. Ponting 2000
‘The Minoan thalassocracy reconsidered: provenance studies of LH II A/LM I B pottery from Phylakopi, Ay. Irini and Athens’, *BSA* 95, 141–84.
- Muhly, P. 1984
‘Minoan hearths’, *AJA* 88, 107–22.
- Muhly, P. 1992
Μινωικός λαξευτός τάφος στον Πόρο Ηρακλείου (ανασκαφής 1967) (Βιβλιοθήκη της εν Αθήναις Αρχαιολογικής Εταιρείας αρ. 129), Athens.
- Müller, W. 1997
Kretische tongefässe mit meeresdekor. Entwicklung und stellung innerhalb der feinen keramik von Spätminoisch I B auf Kreta (AF 19), Berlin.
- Myer, G.H. & P.P. Betancourt 1990
‘The fabrics at Kommos’, in Betancourt 1990, 3–13.
- Myer, G.H., K.G. McIntosh & P.P. Betancourt 1995
‘Definition of pottery fabrics by ceramic petrography’, in Betancourt and Davaras 1995, 143–53.
- Niemeier, W.-D. 1980
‘Die katastrophe von Thera und die Spätminoische chronologie’, *JdI* 95, 1–76.
- Niemeier, W.-D. 1983
‘The character of the Knossian palace society in the second half of the fifteenth century B.C.: Mycenaean or Minoan?’, in *Minoan Society. Proceedings of the Cambridge Colloquium 1981*, O. Krzyszkowska & L. Nixon (eds.), Bristol, 217–27.
- Niemeier, W.-D. 1984
‘The end of the Minoan thalassocracy’, in Hägg & Marinatos 1984, 205–15.
- Niemeier, W.-D. 1985
Die Palaststilkeramik von Knossos. Stil, chronologie und historischer kontext (AF 13), Berlin.
- Niemeier, W.-D. 1994
‘Knossos in the New Palace period (MM III-LM IB)’, in *Knossos. A labyrinth of history. Papers presented in honour of Sinclair Hood*, D. Evely, H. Hughes-Brock & N. Momigliano (eds.), Athens, 71–88.
- Nikolakopoulou, I. 2002
Storage, storage facilities and island economy: the evidence from LC I Akrotiri, Thera, Ph.D. dissertation, University of Bristol.
- Nikolakopoulou, I. 2003
‘Ακρωτήρι Θήρας. Η πόλη σε κατάσταση έκτακτης ανάγκης’, in *Αργοναυτής. Τιμητικός τόμος για τον Καθηγητή Χρίστο Γ. Ντούμα*, A. Vlachopoulos & K. Birtacha (eds.), Athens, 554–73.
- Nikolakopoulou, I. 2006
‘Μινωικοί πίθοι απο το Ακρωτήρι Θήρας’, in *Πεπραγμένα Θ’ Διεθνούς Κρητολογικού Συνεδρίου Α4*, Herakleion, 91–107.
- Nikolakopoulou, I. 2010
‘Middle Cycladic iconography: a social context for ,a new chapter in Aegean art’, *In Cretan offerings. Studies in honour of Peter Warren*, O. Krzyszkowska (ed.), (BSA Studies 18), Athens, 213–22.
- Nikolakopoulou, I., F. Georma, A. Moschou & F. Sophianou 2008
‘Trapped in the middle: new stratigraphic and ceramic evidence from Middle Cycladic Akrotiri, Thera’, in *Horizon. A colloquium on the prehistory of the Cyclades*, N. Brodie, J. Doole, G. Gavalas & C. Renfrew (eds), Cambridge, 311–24.
- Nodarou, E. 2003
‘A petrographic analysis of a clay sample from the field adjacent to the Artisans’ Quarter’, in Barnard & Brogan 2003, 171–4.
- Nowicki, K. 2002
‘A Middle Minoan II deposit at the refuge site of Monastiraki Katalimata (East Crete)’, *Aegean Archaeology* 5, 27–45.
- Nowicki, K. 2008
Monastiraki Katalimata. Excavation of a Cretan refuge site, 1993–2000 (Prehistory Monographs 24), Philadelphia.
- Overbeck, J.C. 1989
Keos. Results of excavations conducted by the University of Cincinnati under the auspices of the American School of Classical Studies at Athens. Vol. VII. Ayia Irini: Period IV. Part 1: the stratigraphy and the find deposits, Mainz.
- Palio, O. 2001a
‘La casa tardo minoico I di Chalara a Festòs’, in *Studi di Archeologia Cretese II*, Padova, 243–422.
- Palio, O. 2001b
‘Tardo Minoico I: la casa di Haghia Fotini’, in *I cento anni dello scavo di Festòs (Roma, 13–14 dicembre 2000)* (Accademia Nazionale dei Lincei: Atti dei Convegni Lincei 173), Rome, 243–72.
- Palio, O. in press
‘Consumo di cibo e attività rituale a Festòs in età neopalaziale: l’edificio di Haghia Photini’, in *Cibo per gli uomini, cibo per gli dei. Archeologia del pasto rituale* (Piazza Armerina – Enna, 4–8 maggio 2005).

- Palyvou, C. 2005
‘Architecture in Aegean Bronze Age art: façades with no interiors’, in Morgan 2005, 185–97.
- Panagiotakis, N. 2003
‘L’évolution archéologique de la Pédiada (Crète centrale): premier bilan d’une prospection’, *BCH* 127, 327–430.
- Papadatos, Y. forthcoming
‘Η μετάβαση από τη Νεολιθική στην Πρώιμη Εποχή του Χαλκού: νέα δεδομένα από τον οικισμό στην Κεφάλα Πετρά Σητείας’, in *Πεπραγμένα του Ι΄ Διεθνούς Κρητολογικού Συνεδρίου*.
- Papadopoulos, S. 1999
Παραδοσιακά Αγγειοπλαστεία της Θάσου, Αθήνα.
- Papagiannopoulou, A.G. 1991
The influence of Middle Minoan pottery on the Cyclades (SIMA-PB 96), Göteborg.
- Papastamatiou, J. et al. 1959a
Geological Map of Greece 1:50,000. Sitia Sheet. Institute for Geology and Subsurface Research, Athens.
- Papastamatiou, J. et al. 1959b
Geological Map of Greece 1:50,000. Ierapetra Sheet. Institute for Geology and Subsurface Research, Athens.
- Pecorella, P.E. 1973
‘Mycenaean pottery from Ayia Irini’, in *Acts of the International Archaeological Symposium ‘The Mycenaeans in the eastern Mediterranean’*, Nicosia 27th March – 2nd April 1972, V. Karageorghis (ed.), Nicosia, 19–24.
- Pecorella, P.E. 1977
Le tombe dell’età del bronzo tardo della necropoli a mare di Ayia Irini ‘Paleokastro’ (Biblioteca di antichità cypriote 4), Rome.
- Pelon, O. 1966
‘Maison d’Hagia Varvara et architecture domestique à Mallia’, *BCH* 90, 552–85.
- Pelon, O. 1970
Fouilles exécutées à Mallia. Exploration des maisons et quartiers d’habitation (1963–1966). Troisième fascicule (ÉtCrét 16), Paris.
- Pelon, O. 1980
Le palais de Malia V, 1 (ÉtCrét 25), Paris.
- Pelon, O. 1992
Guide de Malia. Le palais et la nécropole de Chrysolakkos (École Française d’Athènes: Sites et monuments 9), Athens.
- Pelon, O. 1997
‘Le palais post-palatial à Malia’, in Driessen & Farnoux 1997, 341–55.
- Pelon, O. 2005
‘Les deux destructions du palais de Malia’, in *KPHΣ TEXNITHΣ. L’artisan crétois. Recueil d’articles en l’honneur de Jean-Claude Poursat, publié à l’occasion des 40 ans de la découverte du Quartier Mu*, I. Bradfer-Burdet, B. Detournay & R. Laffineur (eds.), (Aegaeum 26), Liège and Austin, 185–97.
- Pendlebury, J.D.S. 1933
A guide to the Stratigraphical Museum in the palace at Knossos, London.
- Pendlebury, J.D.S. 1939
The Archaeology of Crete. London.
- Pendlebury, H.W., J.D.S.
Pendlebury & M.B. Money-Coutts 1935–36.
‘Excavations in the plain of Lasithi. I. The cave of Trapeza’, *BSA* 36, 5–131.
- Pernier, L. 1935
Il Palazzo Minoico di Festòs. Scavi e studi della Missione Archeologica Italiana a Creta dal 1900 al 1934.
- Vol. I. *Gli strati più antichi e il primo palazzo*, Rome.
- Pernier, L. & L. Banti 1951
Il Palazzo Minoico di Festòs. Scavi e studi della Missione Archeologica Italiana a Creta dal 1900 al 1950.
Vol. II. *Il Secondo Palazzo*, Rome.
- Petrakos, V. 2005
‘Ζάκρος’, *Ergon* 2005, 74–5.
- Phaklaris, P.B. 1990
Αρχαία Κονουρσία. Ανθρώπινη δραστηριότητα και περιβάλλον (Publications of ArchDelt 43), Athens.
- Pilafidis-Williams, K 1998
The sanctuary of Aphaia on Aigina in the Bronze Age, Munich.
- Platon, L. 1996
‘Εργασίες συντήρησης και προκαταρκτικής μελέτης υλικού ανασκαφών Ζάκρου’, *Prakt* 1996, 321–4.
- Platon, L. 1997a
‘Εκθεση εργασιών μελέτης και συντήρησης ευρημάτων των ανασκαφών Ζάκρου’, *Prakt* 1997, 211–4.
- Platon, L. 1997b
‘The Minoan “villa” in eastern Crete. Riza, Akhkladia, and Prophetes Elias, Praissos: two different specimens of one category?’, in Hägg 1997, 187–202.
- Platon, L. 1997c
‘Caractère, morphologie et datation de la baurgade post-palatial de Kèphali Chondrou Viannou’, in Driessen & Farnoux 1977, 357–74.
- Platon, L. 1998
‘Εργασίες μελέτης και συντήρησης ευρημάτων ανασκαφών Ζάκρου’, *Prakt* 1998, 189–93.

- Platon, L. 1999a
‘Ανυπόγραφα έργα τέχνης» στα χέρια ιδιωτών κατά τη νεοανακτορική περίοδο στην Κρήτη’, in *Eliten in der Bronzezeit. Ergebnisse zweier Kolloquien in Mainz und Athen*, Mainz, 37–50.
- Platon, L. 1999b
‘New evidence for the occupation at Zakros before the LM I palace’, in Betancourt *et al.* 1999, 671–81.
- Platon, L. 2000a
‘Ανακτορικά χαρακτηριστικά στη μινωική οικιακή αρχιτεκτονική’, in *Πεπραγμένα του Η’ Διεθνούς Κρητολογικού Συνεδρίου* A3, Herakleion, 51–77.
- Platon, L. 2000b
‘Εργασίες μελέτης και συντήρησης ευρημάτων ανασκαφών Ζάκρου’, *Prakt* 2000, 195–8.
- Platon, L. 2001
‘Εργασίες μελέτης και συντήρησης ευρημάτων ανασκαφών Ζάκρου’, *Prakt* 2001, 137–40.
- Platon, L. 2002a
‘Τα μινωικά αγγεία και το κρασί’, in *Όινοσ παλαιός ηδύποτος. Το κρητικό κρασί από τα προϊστορικά ως τα νεότερα χρόνια*, A.K. Mylopotamitaki (ed.), (Αρχαιολογικού Ινστιτούτου Κρήτης, Αρ. 1), Herakleion, 5–24.
- Platon, L. 2002b
‘The political and cultural influence of the Zakros palace on nearby sites and in a wider context’, in Driessen, Schoep & Laffineur 2002, 145–56.
- Platon, L. 2004
‘Το Υστερομινωικό Ι ανάκτορο της Ζάκρου: μία “Κνωσός” έξω από την Κνωσό;’, in Cadogan, Hatzaki & Vasilakis 2004, 381–92.
- Platon, L. forthcoming
‘Το ανάκτορο και ο μινωικός οικισμός της Ζάκρου, λίγες μόνο ώρες πριν από τη μεγάλη καταστροφή’, in *Πεπραγμένα του Γ’ Διεθνούς Κρητολογικού Συνεδρίου*.
- Platon, L. & E. Karantzali 2003
‘New evidence for the history of the Minoan presence on Karpathos’, *BSA* 98, 189–202.
- Platon, N. 1951
‘Το Ιερόν Μαζά (Καλού Χωριού Πεδιάδος) και τα μινωικά Ιερά Κορυφής’, *CretChron* 5, 96–160.
- Platon N. 1956
‘Ανασκαφή μινωικής αγροικίας εις Ζου Σητείας’, *Prakt* 1956, 232–40.
- Platon, N. 1961
‘Ανασκαφή Κάτω Ζάκρου’, *Prakt* 1961, 216–24.
- Platon, N. 1962
‘Ανασκαφή Ζάκρου’, *Prakt* 1962, 142–68.
- Platon, N. 1963
‘Ανασκαφαι Ζάκρου’, *Prakt* 1963, 160–88.
- Platon, N. 1964
‘Ανασκαφαι Ζάκρου’, *Prakt* 1964, 142–68.
- Platon, N. 1965
‘Ανασκαφαι Ζάκρου’, *Prakt* 1965, 187–224.
- Platon, N. 1966
‘Ανασκαφαι Ζάκρου’, *Prakt* 1966, 139–73.
- Platon, N. 1967
‘Ανασκαφαι Ζάκρου’, *Prakt* 1967, 162–94.
- Platon, N. 1968a
‘Ανασκαφή Ζάκρου’, *Prakt* 1968, 149–83.
- Platon, N. 1968b
‘Η τελική καταστροφή των μινωικών ανακτόρων’, in *Πεπραγμένα του Β’ Διεθνούς Κρητολογικού Συνεδρίου* A, Athens, 220–8.
- Platon, N. 1969
‘Ανασκαφή Ζάκρου’, *Prakt* 1969, 197–237.
- Platon, N. 1970
‘Ανασκαφή Ζάκρου’, *Prakt* 1970, 208–51.
- Platon, N. 1971a
‘Ανασκαφή Ζάκρου’, *Prakt* 1971, 231–75.
- Platon, N. 1971b
Zakros. The discovery of a lost palace of ancient Crete, New York.
- Platon, N. 1972
‘Ανασκαφή Ζάκρου’, *Prakt* 1972, 159–92.
- Platon, N. 1973a
‘Ανασκαφή Ζάκρου’, *Prakt* 1973, 137–66.
- Platon, N. 1973b
‘La chronologie des réceptacles de trésors du sanctuaire – the “Temple Repositories” – et des autres dépôts contemporains du palais de Cnossos’, in *Πεπραγμένα του Γ’ Διεθνούς Κρητολογικού Συνεδρίου* A, Athens, 241–53.
- Platon, N. 1974
Ζάκρος. Το νέον μινωικόν ανάκτορον, Athens.
- Platon, N. 1975
‘Ανασκαφή Ζάκρου’, *Prakt* 1975, 343–75.
- Platon, N. 1976
‘Ανασκαφή Ζάκρου’, *Prakt* 1976, 419–39.
- Platon, N. 1977
‘Ανασκαφή Ζάκρου’, *Prakt* 1977, 421–46.
- Platon, N. 1978
‘Ανασκαφή Ζάκρου’, *Prakt* 1978, 259–99.

- Platon, N. 1985
‘Ανασκαφή Ζάκρου’, *Prakt* 1985, 217–62.
- Platon, N. 1986
‘Ανασκαφή Ζάκρου’, *Prakt* 1986, 243–97.
- Poblome, J. & C. Dumon 1987–8
‘A Minoan building program? Some comments on the Unexplored Mansion at Knossos’, *ActaArchLov* 26–7, 69–73.
- Popham, M. 1967
‘Late Minoan pottery, a summary’, *BSA* 62, 337–51.
- Popham, M. 1969
‘The Late Minoan goblet and kyllix’, *BSA* 64, 299–304.
- Popham, M. 1970a
‘A Late Minoan shrine at Knossos’, *BSA* 65, 191–4.
- Popham, M.R. 1970b
The destruction of the Palace at Knossos. Pottery of the Late Minoan III A period, (SIMA 12), Göteborg.
- Popham, M. 1974
Review of Coldstream & Huxley 1972, *Antiquaries Journal* 54, 320–31.
- Popham, M. 1977
‘Notes from Knossos, part I’, *BSA* 72, 185–95.
- Popham, M. 1978
‘Notes from Knossos, part II’, *BSA* 73, 179–87.
- Popham, M.R. (ed.) 1984
The Minoan Unexplored Mansion at Knossos (BSA Supplement 17), London.
- Popham, M. 1987
‘Four alabaster from Ayia Triadha’, in *Ελληνική. Τόμος τιμητικός για τον Καθηγητή Νικόλαο Πλάτωνα*, L. Kastriaki, G. Orphanou & N. Giannadakis (eds.), Herakleion, 457–60.
- Popham, M.R. 1994
‘Late Minoan II to the end of the Bronze Age’, in *Knossos: a labyrinth of history. Papers presented in honour of Sinclair Hood*, D. Evely, H. Hughes-Brock & N. Momigliano (eds.), Athens, 89–102.
- Poursat, J.-C. 1988
‘La ville minoenne de Malia: recherches et publications récentes’, *RA* 1, 61–82.
- Poursat, J.-C. & C. Knappett 2005
Fouilles exécutées à Mallia. Le Quartier Mu IV. La poterie du minoen moyen II: production et utilisation (ÉtCrét 33), Paris.
- Preston, L. 2004
‘A mortuary perspective on political changes in Late Minoan II-III B Crete’, *AJA* 108, 321–48.
- Psaropoulou, B. 1984
Last potters of the East Aegean, Nauplion.
- Psaropoulou, B. 1990
Η κεραμική του χτέος στα Κύθηρα και στην Κύθνο, Athens.
- Puglisi, D. 2001
‘Il problema degli inizi del TM I nella Messarà alla luce dei nuovi dati da Haghia Triada’, *Creta Antica* 2, 91–104.
- Puglisi, D. 2003a
‘Haghia Triada nel periodo Tardo Minoico I’, *Creta Antica* 4, 145–98.
- Puglisi, D. 2003b
‘Il Bastione Tardo Minoico I ad Haghia Triada: nuove osservazioni su cronologia e funzione’, *ASAtene* 81 (Series III, 3), 573–93.
- Puglisi, D. 2006
Produzioni ceramiche TM I ad Haghia Triada nel contesto della Creta centro-
- meridionale*, Ph.D. dissertation, University of Udine.
- Puglisi, D. 2007
‘L’organizzazione a terrazze nel ‘Villaggio’ TM I di Haghia Triada’, *Creta Antica* 8, 169–200.
- Puglisi, D. forthcoming a
‘Nuovi depositi ceramici Tardo Minoico I da Haghia Triada’, in *Πεπραγμένα του Γ’ Διεθνούς Κρητολογικού Συνεδρίου*.
- Puglisi, D. forthcoming b
‘Le ceramiche Tardo Minoico I dal saggio nell’area della fornace di Haghia Triada’, forthcoming in *Creta Antica* 12.
- Pullen, D.J. 2010a
‘Introduction: political economies of the Aegean Bronze Age’, in Pullen 2010b, 1–11.
- Pullen, D. (ed.) 2010b
Political economies of the Aegean Bronze Age. Papers from the Langford Conference, Florida State University, Tallahassee, 22-24 February 2007, Oxford.
- Quilici, L. 1990
La tomba dell’età del bronzo tardo dall’abitato di Paleokastro presso Ayia Irini (Biblioteca di antichità cypriote 6), Rome.
- Raban, A. 1980
The commercial jar in the ancient Near East: its evidence for interconnections amongst the Biblical Lands, Ph.D. dissertation, Hebrew University.
- Relaki, M. 2004
‘Constructing a region: the contested landscapes of Prepalatial Mesara’, in Barrett & Halstead 2004, 170–88.
- Renfrew, C. 2007
Excavations at Phylakopi in Melos 1974–77 (BSA Supplementary Volume 42), London

- Rethemiotakis, G. 1984
‘Ανασκαφική έρευνα στη Λύκτο’,
Λύκτος 1, 49–65.
- Rethemiotakis, G. 1992–3
‘Το μινωικό ‘κεντρικό κτήριο’ στο
Καστέλλι Πεδιάδας’, *ArchDelt* 47–8,
A, 29–64.
- Rethemiotakis, G. 1994
‘ΚΓ’ Εφορεία Προϊστορικών
και Κλασικών Αρχαιοτήτων.
Ανασκαφικές εργασίες. Γαλατάς
Πεδιάδος’, *ArchDelt* 49 B’2, 701–7.
- Rethemiotakis, G. 1999
‘Το νέο μινωικό ανάκτορο στον
Γαλατά Πεδιάδος και το “ιερό
σπήλαιο” Αρκαλοχωρίου’,
in *Κρήτες Θαλασσοδρόμοι. Κύκλος
διαλέξεων, Ιανουάριος – Απρίλιος 1996
(συνεργασία ΚΓΕΠΚΑ & 13 ΕΒΑ,
χορηγός ΟΑΝΑΚ)*, A. Karestou
(ed.), Herakleion, 91–111.
- Rethemiotakis, G. 2002
‘Evidence on social and economic
changes at Galatas and Pediaa
in the New-Palace period’, in
Driessen, Schoep & Laffineur
2002, 55–69.
- Rethemiotakis, G. & K.S.
Christakis 2004
‘Cultural interaction between
Knossos and Pediaa: the evidence
from the Middle Minoan IB
pottery’, in Cadogan, Hatzaki &
Vasilakis 2004, 169–75.
- Rethemiotakis, G. & K.S.
Christakis, in preparation
‘Power strategies and cultural
idiosyncrasies: an assessment of
the current evidence from the
Protopalatial settlement at Galatas,
Pediaa’ (to be submitted in the
BSA).
- Rice, P.M. 1976
‘Rethinking the ware concept’,
American Antiquity 41, 538–43.
- Rice, P.M. 1987
Pottery analysis. A sourcebook,
Chicago.
- Richards, C.C., & J.S. Thomas
1984
‘Ritual activity and structured
deposition in later Neolithic
Wessex’, in *Neolithic studies: a review
of some current research*, R. J. Bradley
& J. Gardiner (eds.), (BAR-BS
133), Oxford, 189–218.
- Riley, J.A. 1983
‘The contribution of ceramic
petrology to our understanding
of Minoan society’, in *Minoan
Society. Proceedings of the Cambridge
Colloquium 1981*, O. Krzyszkowska
& L. Nixon (eds.), Bristol, 283–92.
- Rizza G. & M. Rizzo 1984
‘Prinias’, in Di Vita 1984b, 227–
56.
- Roehrig, C.H., R. Dreyfus & C.A.
Keller (eds.) 2005
Hatshepsut: from Queen to Pharaoh,
New York.
- Rutter, J. B. 1998
‘Review of Hallager & Hallager
1997, *AJA* 102, 435–6.
- Rutter, J.B. 2004
‘Ceramic sets in context: one
dimension of food preparation and
consumption in a Minoan palatial
setting’, in *Food, cuisine and society
in prehistoric Greece*, P. Halstead
& J.C. Barrett (eds.), (Sheffield
Studies in Archaeology 5), Oxford,
63–89.
- Rutter, J.B. 2006a
‘Neopalatial and later Minoan
pottery’, in Shaw & Shaw 2006,
377–630.
- Rutter, J.B. 2006b
‘Ceramic imports of the
Neopalatial and later Bronze Age
eras’, in Shaw & Shaw 2006,
646–88.
- Rutter, J.B. 2006c
‘Southwestern Anatolian pottery
from Late Minoan Crete: evidence
for direct contacts between Arzawa
and Keftiu?’, in Wiener *et al.* 2006,
138–53.
- Rutter, J.B. in progress
*Kommos: House X, A Minoan
mansion near the sea II: the pottery*,
Philadelphia.
- Rutter, J.B. & S.H. Rutter 1976
*The transition to Mycenaean. A
stratified Middle Helladic II to
Late Helladic IIA pottery sequence
from Ayios Stephanos in Lakonia*
(Monumenta Archaeologica 4),
Los Angeles.
- Rutter, J.B. & A. Van de Moortel
2006
‘Minoan pottery from the
Southern Area’, in Shaw & Shaw
2006, 261–715.
- Sackett, L.H. 1992
*Knossos: from Greek city to Roman
colony. Excavations at the Unexplored
Mansion 2* (BSA Supplement 21),
London.
- Sackett, H. 1996
‘A bull’s head rhyton from
Palaikastro’, in Evely, Lemos &
Sherratt 1996, 51–8.
- Sackett, L.H. 2006
*The Palaikastro kouros. A masterpiece
of Minoan sculpture in ivory and gold*,
Athens.
- Sackett, L.H. & M. Popham 1970
‘Excavations at Palaikastro VII’,
BSA 65, 203–42.
- Sackett, L.H., M.R. Popham &
P.M. Warren 1965
‘Excavations at Palaikastro VI’,
BSA 60, 248–315.
- Sakellarakis, Y. 1983
‘Ανασκαφή Ιδαίου Άνδρου’, *Prakt*
1983, 415–500.

- Sakellarakis, Y. 1984
'Ανασκαφή Ιδαίου Άνδρου', *Prakt* 1984, 507–99.
- Sakellarakis, Y. 1996
Digging for the past, Athens.
- Sakellarakis, Y. & D. Panagiotopoulos 2004
'Ανασκαφή Ζομίνθου', *Prakt* 2004, 99–110.
- Sakellarakis, Y. & D. Panagiotopoulos 2006
'Minoan Zominthos', in *O Μυλοπόταμος απο την αρχαιότητα ως σήμερα. Περιβάλλον – αρχαιολογία – ιστορία – λαογραφία – κοινωνιολογία. II: αρχαίοι χρόνοι*, E. Gavrilaki & Y.Z. Tzifopoulos (eds.), Rethymnon, 47–75.
- Sakellarakis, Y. & E. Sapouna-Sakellarakis 1991
Archanes, Athens.
- Sakellarakis, Y. & E. Sakellarakis 1997
Archanes. Minoan Crete in a new light, Athens.
- Sakellariou, A. 1980
'The West House miniature frescoes', in *Thera and the Aegean world II. Papers and proceedings of the Second International Scientific Congress, Santorini, Greece, August 1978*, C. Doumas (ed.), London, 147–53.
- Sapouna-Sakellarakis, E. 1988–9
'Η κεραμική του θαλάσσιου ρυθμού από τις Αρχάνες και η πιθανή ύπαρξη τοπικού εργαστηρίου', *CretChron* 28–9, 28–52.
- Sarpaki, A. 1992
'A palaeoethnobotanical study of the West House, Akrotiri', *BSA* 87, 219–30.
- Sarpaki, A. 2001
'Processed cereals and pulses from the Late Bronze Age site of Akrotiri, Thera: preparations prior to consumption. A preliminary approach to their study', *BSA* 96, 27–40.
- Schäfer, J. 1992
Amnisos. Nach den archäologischen, historischen und epigraphischen zeugnissen des altertums und der neuzeit, Berlin.
- Scheffer, C. 1984
'Aegean, bronze-age, spit supports with scalloped tops', *OpAth* 15, 155–62.
- Schiffer, M.B. 1987
Formation process of the archaeological record, Albuquerque.
- Schoch, M. 1995
Die minoische chronologie: möglichkeiten und grenzen konventioneller und naturwissenschaftlicher methoden (Documenta naturae no.94), Munich.
- Schoep, I.M. 1999
'Tablets and territories? Reconstructing Late Minoan IB political geography through undeciphered documents', *AJA* 103, 201–21.
- Schoep, I.M. 2002
The administration of Neopalatial Crete. A critical assessment of the Linear A tablets and their role in the administrative process (Minos Supplement 17), Salamanca.
- Schoep, I. 2004
'The socio-economic context of seal use and administration at Knossos', in Cadogan, Hatzaki & Vasilakis 2004, 283–94.
- Seager, R.B. 1907
'Report of excavations at Vasiliki, Crete, in 1906', in *Transactions of the Free Museum of Science and Art (University Museum)* 2:2, Philadelphia, 111–32.
- Seager, R.B. 1910
Excavations on the island of Pseira, Crete, Philadelphia.
- Shaw, J.W. 2009
Minoan architecture: materials and techniques, Padova.
- Shaw, J.W. & M.C. Shaw (eds.) 1985
A great Minoan triangle in southcentral Crete: Kommos, Hagia Triadha, Phaistos (Scripta Mediterranea 6), Toronto.
- Shaw, J.W. & M. Shaw (eds.) 1996
Kommos I. The Kommos region and houses of the Minoan town, Princeton.
- Shaw, J.W. & M.C. Shaw (eds.) 2006
Kommos V. The monumental Minoan buildings at Kommos, Princeton.
- Shaw, J.W., A. Van de Moortel, P.M. Day & V. Kilikoglou 2001
A LM IA ceramic kiln in south-central Crete. Function and pottery production (Hesperia Supplement 30), Princeton.
- Shelmerdine, C.W. (ed.) 2008
The Cambridge companion to the Aegean Bronze Age, Cambridge.
- Siebenmorgen, H. (ed.) 2000
Im labyrinth des Minos. Kreta – erste europäische hochkultur. Ausstellung des Badischen Landesmuseums 27.1. bis 29.4.2001, Karlsruhe, Schloss (Archäologische Veröffentlichungen des Badischen Landesmuseums Band 2), Munich.
- Silverman, J. 1978
'The LM IB painted pottery of eastern Crete', *TUAS* 3, 31–5.
- Smith, A.T. 2003
The political landscape. Constellations of authority in early complex polities, Berkeley.

- Sofianou, Ch. & T.M. Brogan 2009
‘The excavation of House A.1 at Papadiokampos’, *Kentro. The newsletter of the INSTAP Study Center for East Crete* 12, 6–9.
- Sofianou, Ch. & T.M. Brogan 2010
‘Μινωικός οικισμός Παπαδιόκαμπου Σητείας. Η ανασκαφή της οικίας Β1 κατά το 2008’, in *Αρχαιολογικό Έργο Κρήτης 1. Πρακτικά της 1ης Συνάντησης Ρέθυμνο, 28–30 Νοεμβρίου* 2008, M. Andrianakis & I. Tzachili (eds.), Rethymnon, 134–42.
- Soles, J.S. 2002
‘A central court at Gournia?’, in Driessen, Schoep & Laffineur 2002, 123–32.
- Soles, J.S. 2003
Mochlos IA. Period III. Neopalatial settlement on the coast: the Artisans’ Quarter and the farmhouse at Chalinomouri. The sites, Philadelphia.
- Soles, J.S. 2004
‘New construction at Mochlos in the LM IB period’, in Day, Mook & Muhly 2004, 153–62.
- Soles, J.S. 2004b
Mochlos IC. Period III. Neopalatial settlement on the coast: the Artisans’ Quarter and the Farmhouse at Chalinomouri. The small finds, (Prehistory Monographs 9), Philadelphia.
- Soles, J.S. 2009
‘The impact of the Minoan eruption of Santorini on Mochlos, a small Minoan town on the north coast of Crete’, in Warburton 2009, 107–16.
- Soles, J.S. & T.M. Brogan 2008
‘The Late Minoan III settlement’, in *Mochlos IIA. Period IV. The Mycenaean settlement and cemetery. The sites*, J.S. Soles & C. Davaras (eds.), (Prehistory Monographs 23), Philadelphia, 5–128.
- Soles, J.S. & C. Davaras 1990
‘Theran ash in Minoan Crete: new excavations on Mochlos’, in Hardy & Renfrew 1990, 89–95.
- Soles, J.S. & C. Davaras 1992
‘Excavations at Mochlos, 1989’, *Hesperia* 61, 413–45.
- Soles, J.S. & C. Davaras 1994
‘Excavations at Mochlos, 1990–1991’, *Hesperia* 63, 391–436.
- Soles, J.S. & C. Davaras 1996
‘Excavations at Mochlos, 1992–1993’, *Hesperia* 65, 175–230.
- Tainter, J.A. 1988
The collapse of complex societies, Cambridge.
- Tarling, D.H. & W.S. Downey 1989
‘Archaeomagnetic study of the Late Minoan Kiln 2, Stratigraphical Museum Extension, Knossos’, *BSA* 84, 345–52.
- Tarling, D.H. & W.S. Downey 1990
‘Archaeomagnetic results from Late Minoan destruction levels on Crete and the ‘Minoan’ tephra on Thera’, in Hardy & Renfrew 1990, 146–59.
- Touchais, G. 1989
‘Chronique des fouilles et découvertes archéologiques en Grèce en 1988’, *BCH* 113, 581–788.
- Tournavitou, I. 2000
‘Μινωικό ιερό κορυφής στα Κύθηρα: η κεραμεική’, in *Πεπραγμένα Η’ Διεθνούς Κρητολογικού Συνεδρίου* A3, Herakleion, 297–316.
- Traunmueller, S. 2009
The Neopalatial pottery from the ceramic workshop at Zominthos and its implications for Minoan relative chronology, Ph.D. dissertation, University of Heidelberg.
- Tsakanika-Theochari, E. 2006
Ο δομικός ρόλος του ξύλου στην τοιχοποιία των ανακτορικών τύπων κτιρίων της Μινωικής Κρήτης, Ph.D. dissertation, Εθνικό Μετσόβιο Πολυτεχνείο, Τμήμα Αρχιτεκτόνων Μηχανικών.
- Tsipopoulou M. 1990
‘Νέα στοιχεία για τη μινωική κατοίκηση στην περιοχή της πόλης της Σητείας’, in *Πεπραγμένα του ΣΤ’ Διεθνούς Κρητολογικού Συνεδρίου* A2, Khandia, 305–21.
- Tsipopoulou, M. 1995
‘Κεραμεικά σημεία από την ανασκαφή Πετρά Σητείας (1989–1990)’, in *Πεπραγμένα του Ζ’ Διεθνούς Κρητολογικού Συνεδρίου* A2, Rethymnon, 931–71.
- Tsipopoulou, M. 1997
‘Late Minoan III reoccupation in the area of the Palatial Building at Petras, Siteia’, in Hallager & Hallager 1997, 209–57.
- Tsipopoulou, M. 1998
‘The hieroglyphic archive at Petras, Siteia’, *BCH* 122, 436–40.
- Tsipopoulou, M. 1999
‘Before, during, after: architectural phases of the Palatial Building at Petras, Siteia’, in Betancourt *et al.* 1999, 847–56.
- Tsipopoulou, M. 2002
‘Petras, Siteia: the palace, the town, the hinterland and the Protopalatial background’, in Driessen, Schoep, & Laffineur, 133–44.
- Tsipopoulou, M. 2007
‘The central court of the Palace of Petras’, in *Krinoi and limenes. Studies in honor of Joseph and Maria Shaw* (Prehistory Monographs 22), P.P. Betancourt, M.C. Nelson & H. Williams (eds.), Philadelphia, 49–59.

- Tsiporoulou, M. forthcoming
 'Πρόσφατα ευρήματα στον Πετρώ Σητείας. Οι ανασκαφές του 21^{ου} αιώνα', in *Πεπραγμένα του 1^{ου} Διεθνούς Κρητολογικού Συνεδρίου*.
- Tsiporoulou, M. & H. Dierckx 2006
 'Υστερομινωικό ΙΑ Σπίτι Ι.1 στον Πετρώ Σητείας: δομή, λειτουργία και κατανομή των ευρημάτων', *Πεπραγμένα του Θ' Διεθνούς Κρητολογικού Συνεδρίου Α1*, Herakleion, 298–315.
- Tsiporoulou, M. & B. Hayden 2005
 'Excavations at Priniatikos Pyrgos, Istron, Mirabello, 2005', *Kentro* 8, 2–7.
- Tsiporoulou, M. & E. Hallager 1996a
 'Inscriptions with hieroglyphs and Linear A from Petras, Siteia', *SMEA* 37, 7–46.
- Tsiporoulou, M. & E. Hallager 1996b
 'A new hieroglyphic archive at Petras, Siteia', *Kadmos* 35, 164–7.
- Tsiporoulou, M. & L. Vagnetti 1994
 'A Late Minoan III grey wheel-made piriform jar from eastern Crete', *SMEA* 34, 43–50.
- Tsiporoulou, M. & A. Papacostopoulou 1997
 "'Villas" and villages in the hinterland of Petras, Siteia', in Hägg 1997, 203–14.
- Tsiporoulou, M. & L. Vagnetti 1995
Achladia. Scavi e ricerche della Missione Greco-Italiana in Creta Orientale (1991–1993) (Incunabula Graeca 97), Rome.
- Tsiporoulou, M. & M. Wedde 2000
 'Διαβάζοντας ένα χωματίνο παλίμψηστο: στρωματογραφικές τομές στο ανακτορικό κτίριο του Πετρώ Σητείας', *Πεπραγμένα του Η' Διεθνούς Κρητολογικού Συνεδρίου Α3*, Herakleion, 359–77.
- Tzedakis, Y. 1973–4
 'Αρχαιότητες και μνημεία δυτικής Κρήτης', *ArchDelt* 29 Β'3, 917–21.
- Tzedakis, Y. 1977
 'Αρχαιότητες και μνημεία δυτικής Κρήτης', *ArchDelt* 32 Β'2, 323–33.
- Tzedakis, Y. 1980
 'ΚΕ' Εφορεία Προϊστορικών και Κλασικών Αρχαιοτήτων', *ArchDelt* 35 Β'2, 501–17.
- Tzedakis, Y., S. Chryssoulaki, Y. Venieri & M. Avgouli 1990
 'Les routes minoennes: le poste de Χοιρόμανδρες et le contrôle des communications', *BCH* 114, 43–65.
- Tzedakis, Y. & H. Martlew (eds.) 1999
Minoans and Mycenaeans. Flavours of their time. National Archaeological Museum, 12 July – 27 November 1999, Athens.
- Tzedakis, I. & A. Sacconi (eds.) 1989
Scavi a Nerokourou, Kydonias (Incunabula Graeca 90), Rome.
- Vagnetti, L. 1977
 'Tracce di due insediamenti neolitici nel territorio dell'antica Gortina', *AntCr* 1, 1–9.
- Vallianou, D. 1996
 'New evidence of earthquake destructions in Late Minoan Crete', in *Archaeoseismology*, S. Stiros & R.E. Jones (eds.), (Fitch Laboratory Occasional Paper 7), Athens, 153–67.
- Van de Moortel, A. 1997
The transition from the Protopalatial to the Neopalatial society in south-central Crete: a ceramic perspective, Ph.D. dissertation, Bryn Mawr College.
- Van de Moortel, A. 2001
 'The area around the kiln, and the pottery from the kiln and the kiln dump', in Shaw *et al.* 2001, 25–110.
- Van de Moortel, A. & P. Darcque 2006
 'Late Minoan I architectural phases and ceramic chronology at Malia', in *Πεπραγμένα Θ' Διεθνούς Κρητολογικού Συνεδρίου Α1*, Herakleion, 177–88.
- Van Effenterre, H. 1980
Le palais de Mallia et la cité minoenne II (Incunabula Graeca 76), Rome.
- Van Effenterre, H. & M. Van Effenterre 1969
Fouilles exécutées à Mallia. Le centre politique I. L'agora (1960–1966) (ÉtCrét 17), Paris.
- Van Effenterre, H. & M. Van Effenterre 1976
Fouilles exécutées à Mallia. Explorations des maisons et quartiers d'habitation (1956–1960) (ÉtCrét 22), Paris.
- Vasilakis, A. 1997
Τύλισος, Tylisos.
- Vitale, S. 2006
 'L'insediamento di "Serraglio" durante il Tardo Bronzo. Riesame dei principali contesti portati alla luce da Luigi Morricone tra il 1935 ed il 1946', *ASAtene* 83 (Series III, 5), 71–94.
- Vitaliano, C.J. & D.B. Vitaliano 1998
 'Volcanic ash and pumice studies', in Betancourt & Davaras 1998a, 43–6.
- Vokotopoulos, L. 2006
 'Το κτηριακό συγκρότημα του «Φυλακίου της θάλασσας» στις Καρούμες Σητείας', in *Πεπραγμένα Θ' Διεθνούς Κρητολογικού Συνεδρίου Α1*, Herakleion, 347–63.

- Vokotopoulos, L. 2007
Το κρηιακό συγκρότημα του Φυλακίου της Θάλασσας στον όρμο Καρούμες και η περιοχή του. Ο χαρακτήρας της κατοίκησης στην ύπαιθρο της ανατολικής Κρήτης κατά τη Νεοανακτορική εποχή, Ph.D. dissertation, Aristotle University of Thessaloniki.
- Vokotopoulos, L. forthcoming
‘A view of the Neopalatial countryside: settlement and social organization in the area of Karoumes, eastern Crete’, in *STEGA: The archaeology of houses and households in ancient Crete*, N. Vogeikoff-Brogan & K. Glowacki (eds.), (Hesperia Suppl. Series), Princeton.
- Voyatzoglou, M. 1984
‘Thrapsano, village of jar makers. Traditional ceramics in modern Greece’, in Betancourt 1984a, 130–42.
- Wace, A.J.B. & C.W. Blegen 1939
‘Pottery as evidence for trade and colonisation in the Aegean Bronze Age’, *Klio* 32, 131–47.
- Walberg, G. 1981
‘Mittelminoische keramik. Methoden und probleme’, *AA* 1981, 1–14.
- Walberg, G. 1992
Middle Minoan III – a time of transition (SIMA 97), Jonsered
- Wall, S.M., J.H. Musgrave & P.M. Warren 1986
‘Human bones from a Late Minoan IB house at Knossos’, *BSA* 81, 333–88.
- Warburton, D.A. (ed.) 2009
Time’s up! Dating the Minoan eruption of Santorini. Acts of the Minoan Eruption Chronology Workshop, Sandbjerg November 2007 initiated by Jan Heinemeier & Walter L. Friedrich (Monographs of the Danish Institute at Athens 10), Athens.
- Warren, P. 1972
Myrtos. An Early Bronze Age settlement in Crete (BSA Supplement 7), London.
- Warren, P. 1973a
‘Knossos. Excavation in the area of the Royal Road’, *ArchDelt* 28 B’2, 574–6.
- Warren, P. 1973b
Review of Coldstream and Huxley 1972, *Antiquity* 47, 321–3.
- Warren, P.M. 1980–1
‘Knossos: Stratigraphical Museum excavations, 1978–1980. Part I’, *AR* 27, 73–92.
- Warren, P. 1981
‘Minoan Crete and ecstatic religion. Preliminary observations on the 1979 excavations at Knossos’, in *Sanctuaries and cults in the Aegean Bronze Age. Proceedings of the First International Symposium at the Swedish Institute in Athens, 12–13 May, 1980*, R. Hägg & N. Marinatos (eds.), (SkrAth 4°, 28), Stockholm 155–67.
- Warren, P.M. 1982–3
‘Knossos: Stratigraphical Museum excavations, 1978–1982. Part II’, *AR* 29, 63–87.
- Warren, P. 1984a
‘Circular platforms at Minoan Knossos’, *BSA* 79, 307–23.
- Warren, P. 1984b
‘Knossos: new excavations and discoveries’, *Archaeology* 37 (4), 48–56.
- Warren, P. 1988
Minoan religion as ritual action, Göteborg.
- Warren, P.M. 1990–1
‘The Minoan civilisation of Crete and the volcano of Thera’, *Journal of the Ancient Chronology Forum* 4, 29–39.
- Warren, P. 1991
‘A new Minoan deposit from Knossos, c. 1600 B.C., and its wider relations’, *BSA* 86, 319–40.
- Warren, P. 1996
‘A new Minoan decoration – the Jackson Pollock style – and its place in Minoan art’, in Evely, Lemos & Sherratt 1996, 46–50.
- Warren, P. 1999
‘LM IA: Knossos, Thera, Gournia’, in Betancourt *et al.* 1999, 893–903.
- Warren, P. 2001
Review of Driessen & Macdonald 1997, *AJA* 105, 115–8.
- Warren, P.M. 2002
‘Political Structure in Neopalatial Crete’, in Driessen, Schoep & Laffineur 2002, 201–5.
- Warren, P. 2004
‘Terra cognita? The territory and boundaries of the early Neopalatial Knossian state’, in Cadogan, Hatzaki & Vasilakis 2004, 159–68.
- Warren, P. 2005
‘Flowers for the goddess? New fragments of wall paintings from Knossos’, in Morgan 2005, 131–48.
- Warren, P.M. 2006
‘The date of the Thera eruption in relation to Aegean-Egyptian interconnections and the Egyptian historical chronology’, in *Timelines. Studies in honour of Manfred Bietak* II, E. Czerny, I. Hein, H. Hunger, D. Melman & A. Schwab (eds.), (Orientalia Lovaniensia Analecta 149), Leuven, 305–21.
- Warren, P. & V. Hankey 1989
Aegean Bronze Age chronology, Bristol.
- Watrous, L.V. 1981
‘The relationship of Late Minoan II to Late Minoan III A1’, *AJA* 85, 75–7.

- Watrous, L.V. 1992
Kommos III. The Late Bronze Age pottery, Princeton.
- Watrous, L.V. & D. Hadzi-Vallianou 2004
‘Palatial rule and collapse (Middle Minoan IB-Late Minoan IIIB)’, in Watrous, Hadzi-Vallianou & Blitzer 2004, 277–304.
- Watrous, L.V., D. Hadzi-Vallianou & H. Blitzer 2004
The plain of Phaistos. Cycles of social complexity in the Mesara region of Crete (Monumenta Archaeologica 23), Los Angeles.
- Weingarten, J. 1990
‘Three upheavals in Minoan sealing administration: evidence for radical change’, in *Aegean seals, sealings, and administration. Proceedings of the NEH-Dickinson Conference of the Program of Aegean Scripts and Prehistory of the Department of Classics, University of Texas at Austin, January 11-13 1989*, T. Palaima (ed.), Liège, 105–20.
- Whitbread, I.K. 1995
Greek transport amphorae. A petrological and archaeological study (BSA Fitch Laboratory Occasional Paper 4), Athens.
- Whitelaw, T. 2001
‘From sites to communities: defining the human dimensions of Minoan urbanism’, in Branigan 2001, 15–37.
- Whitelaw, T. 2000
‘191. Φιάλη και κύπελλα. 192. Άωτα κύπελλα. 193. Λοπάδια και κύπελλα’, in Karetsoy, Andreadaki-Vlazaki & Papadakis 2000, 197–9.
- Whitelaw, T., P.M. Day, E. Kiriati, V. Kilikoglou, & D.E. Wilson 1997
‘Ceramic traditions at EM IIB Myrtos Fournou Korifi’, in Laffineur and Betancourt 1997, 265–74.
- Whitley, J. et al. 2007
‘Archaeology in Greece 2006–2007’, *AR* 53, 1–122.
- Wiener, M.H. 1984
‘Crete and the Cyclades in LM I: the tale of the conical cups’, in Hägg & Marinatos 1984, 261–6.
- Wiener, M.H. 1990
‘The isles of Crete? The Minoan thalassocracy revisited’, in Hardy et al. 1990, 128–61.
- Wiener, M.H., J.L. Warner, J. Polonsky & E.E. Hayes (eds.) 2006
Pottery and society. The impact of recent studies in Minoan pottery. Gold Medal Colloquium in honor of Philip P. Betancourt (104th Annual Meeting of the Archaeological Institute of America, New Orleans, Louisiana, 5 January 2003), Boston.
- Wilson, D. & P. Day 1994
‘Ceramic regionalism in Prepalatial central Crete: the Mesara imports at EM I to EM IIA Knossos’, *BSA* 89, 1–87.
- Xanthoudides, S.A. 1922
‘Μινωικόν μέγαρον Νιζου’, *ArchEph* 1922, 1–25.
- Zapheiropoulou, D. 2007
Archaeological Museum of Herakleion. Temporary exhibition, Athens.
- Zerner, C., P. Zerner & J. Winder (eds.) 1993
Proceedings of the international conference “Wace and Blegen: pottery as evidence for trade in the Aegean Bronze Age, 1939–1989” held at the American School of Classical Studies at Athens, Athens, December 2–3, 1989, Amsterdam.
- Zois, A. 1976
Ανασκαφή Βρυσών Κυδωνίας I. 1974, Athens.