



UNIVERSITÀ  
DEGLI STUDI  
FIRENZE

## FLORE

# Repository istituzionale dell'Università degli Studi di Firenze

### **Cascade refrigeration system with inverse Brayton cycle on the cold side**

Questa è la Versione finale referata (Post print/Accepted manuscript) della seguente pubblicazione:

*Original Citation:*

Cascade refrigeration system with inverse Brayton cycle on the cold side / Giannetti, Nicolã²; Milazzo, Adriano; Rocchetti, Andrea; Saito, Kiyoshi. - In: APPLIED THERMAL ENGINEERING. - ISSN 1359-4311. - STAMPA. - 127:(2017), pp. 986-995. [10.1016/j.applthermaleng.2017.08.067]

*Availability:*

This version is available at: 2158/1123062 since: 2018-04-03T12:30:07Z

*Published version:*

DOI: 10.1016/j.applthermaleng.2017.08.067

*Terms of use:*

Open Access

La pubblicazione è resa disponibile sotto le norme e i termini della licenza di deposito, secondo quanto stabilito dalla Policy per l'accesso aperto dell'Università degli Studi di Firenze (<https://www.sba.unifi.it/upload/policy-oa-2016-1.pdf>)

*Publisher copyright claim:*

Conformità alle politiche dell'editore / Compliance to publisher's policies

Questa versione della pubblicazione è conforme a quanto richiesto dalle politiche dell'editore in materia di copyright.

This version of the publication conforms to the publisher's copyright policies.

(Article begins on next page)

# CASCADE REFRIGERATION SYSTEM WITH INVERSE BRAYTON CYCLE ON THE COLD SIDE

Niccolò GIANNETTI<sup>(\*)</sup>, Adriano MILAZZO<sup>(\*\*)</sup>, Andrea ROCCHETTI<sup>(\*\*)</sup>, Kiyoshi SAITO<sup>(\*)</sup>

<sup>(\*)</sup> Waseda University, Department of Applied Mechanics and Aerospace Engineering, 3-4-1 Okubo,  
Shinjuku-ku, Tokyo 169-8555, Japan

[niccolo@aoni.waseda.jp](mailto:niccolo@aoni.waseda.jp), [saitowaseda@gmail.com](mailto:saitowaseda@gmail.com)

Tel/Fax: +81-3-5286-3259 (Japan)

<sup>(\*\*)</sup> University of Florence, Department of Industrial Engineering, Via di Santa Marta 3, Florence, 50139 Italy  
[adriano.milazzo@unifi.it](mailto:adriano.milazzo@unifi.it), [andrea.rocchetti@unifi.it](mailto:andrea.rocchetti@unifi.it)

Keywords: Cold-store refrigeration; Cascade system; Inverse Brayton cycle; Performance analysis

## ABSTRACT

Low temperature refrigeration of cold stores poses some specific issues: single stage, vapour compression cycles have modest COP at low evaporation temperature; cold evaporator surfaces require de-frosting and a fan for air circulation; a part of the refrigeration load may be delivered at intermediate temperature levels, e.g. for the cold store loading dock.

Cascade system may improve the COP and add flexibility on the temperature levels and working fluids, but the problems related to the cold evaporator surface remain unsolved.

The refrigeration system presented herein features a cascade configuration combining a vapour compression cycle and an inverse Brayton cycle. Both cycles use “natural” fluids, complying with strictest regulations. The top cycle uses Ammonia in order to increase efficiency, while the bottom cycle uses air, which directly circulates in the cold space and hence eliminates the cold heat exchanger. A detailed thermodynamic analysis allows a complete screening of the relevant design parameters for an overall system optimization.

The results show that, notwithstanding the intrinsic gap of efficiency suffered by the Brayton cycle, the proposed system features an acceptable global performance and widens the implementation field of this technology. This system configuration shows a COP 50% higher than the corresponding simple Brayton cycle at temperatures of the refrigerated storage of -50°C.

28	<b>Nomenclature</b>	54	$\pi$	Compression ratio
29	$A$			Cross-section area [ $\text{m}^2$ ]
30	$c_p$			Isobaric specific heat [ $\text{kJ}\cdot\text{kg}^{-1}\text{K}^{-1}$ ]
31	$c_v$			Isochoric specific heat [ $\text{kJ}\cdot\text{kg}^{-1}\text{K}^{-1}$ ]
32	$COP$			Coefficient of performance
33	$G$			Mass velocity [ $\text{kg}\cdot\text{m}^{-2}\text{s}^{-1}$ ]
34	$h$			Specific enthalpy [ $\text{kJ}\cdot\text{kg}^{-1}$ ]
35	$J$			Humid air specific enthalpy [ $\text{kJ}\cdot\text{kg}^{-1}$ ]
36	$k$			Heat capacity ratio
37	$L$			Axial length [m]
38	$\dot{m}$			Mass flow rate [ $\text{kg}\cdot\text{s}^{-1}$ ]
39	$P$			Absolute pressure [kPa]
40	$Q_f$			Cooling load [kW]
41	$r$			Latent heat [ $\text{kJ}\cdot\text{kg}^{-1}$ ]
42	$s$			Specific entropy [ $\text{kJ}\cdot\text{kg}^{-1}\text{K}^{-1}$ ]
43	$S$			Transfer surface [ $\text{m}^2$ ]
44	$T$			Temperature [K]
45	$W$			Power [kW]
46	$x$			absolute humidity
47	$z$			Compressibility factor
48				
49	<b>Greek symbols</b>			
50	$\alpha$			Transfer area per unit volume [ $\text{m}^{-1}$ ]
51	$\beta$			Heat transfer coefficient [ $\text{W}\cdot\text{m}^{-2}\text{K}^{-1}$ ]
52	$\varepsilon$			Thermal effectiveness
53	$\eta$			Efficiency
		54	$\pi$	Compression ratio
		55		
		56	<b>Subscripts</b>	
		57	<i>air</i>	Air
		58	<i>amb</i>	Ambient
		59	<i>aux</i>	Auxiliary fan
		60	<i>B</i>	Inverse Brayton
		61	<i>C</i>	Compressor
		62	<i>cond</i>	Condenser
		63	<i>corr</i>	Accounting for fan and defrost loads
		64	<i>el</i>	Electrical
		65	<i>eva</i>	Evaporator/Cascade heat exchanger
		66	<i>ice</i>	Ice
		67	<i>is</i>	Iso-entropic
		68	LD	Loading dock
		69	max	Maximum
		70	<i>mech</i>	Mechanical
		71	min	Minimum
		72	<i>R</i>	Regenerative heat exchanger
		73	<i>RS</i>	Cold storage
		74	<i>sat</i>	Saturation
		75	<i>sh</i>	Super-heat
		76	<i>T</i>	Expander
		77	<i>v</i>	Water vapour
		78	<i>VC</i>	Vapour compression
		79		
		80		

81

82

## 1. INTRODUCTION

### 1.1 Cascade systems

The low storing temperature required by many perishable goods may be efficiently guaranteed by a staged refrigeration system, featuring one or more intermediate temperature levels. This reduces the irreversibilities of the thermodynamic cycle, both on the compression and on the expansion side. Cascade refrigeration systems, when compared to other staged configurations (e.g. double stage with economizer), offer an additional degree of freedom for their optimization, i.e. the choice of a suitable combination of refrigerant fluids, and may offer enhanced performance [1]. Ideally, the refrigerants should be environmentally friendly, non-flammable, non-toxic, and yield the lowest possible initial investment and operative cost.

Several thermodynamic simulations for low temperature refrigeration systems have been reported in the literature. A summary is presented in Table 1. Apparently, NH<sub>3</sub> is the best choice as a fluid for the high temperature cycle (apart from ethanol). CO<sub>2</sub> is often proposed for the low temperature cycle, as it is environmentally safe, non-flammable and non-toxic. However, it has a worsening effect on COP, as shown e.g. by comparing the result of Kilicarslan and Hosoz [2], who used R23, with Lee et al. [3], who used CO<sub>2</sub>.

96

97

Table 1 – Literature results of simulations for cascade refrigeration systems

Reference	HT Fluid	LT Fluid	$T_{cond}$	$T_{eva}$	COP
Aminyavari et al. 2014 [5]	NH <sub>3</sub>	CO <sub>2</sub>	40	-49	1.5
Nasruddin et al. 2016 [6]	C <sub>3</sub> H <sub>8</sub>	C <sub>2</sub> H <sub>6</sub> + CO <sub>2</sub>	56	-49	0.79
Di Nicola et al. 2011 [4]	NH <sub>3</sub>	C <sub>2</sub> H <sub>6</sub>	40	-70	0.97
		C <sub>3</sub> H <sub>8</sub>			1.01
		C <sub>2</sub> H <sub>6</sub> + CO <sub>2</sub>			0.93
		C <sub>3</sub> H <sub>8</sub> + CO <sub>2</sub>			0.87
Gettu, Bansal 2008 [7]	NH <sub>3</sub>	CO <sub>2</sub>	40	-50	1.43
	Ethanol				1.5
	R404				1.35
Lee et al. 2006 [3]	NH <sub>3</sub>	CO <sub>2</sub>	30	-55 ÷ -45	1.1 ÷ 1.44
			35		1.01 ÷ 1.31
			40		0.92 ÷ 1.2
Kilicarslan, Hosoz 2010 [2]	NH <sub>3</sub>	R23	40	-65 ÷ -45	0.89 ÷ 1.25
	R134				0.77 ÷ 1.08
	R404				0.64 ÷ 0.8
Mosaffa et al. 2016 [8]	NH <sub>3</sub>	CO <sub>2</sub>	35	-45 ÷ -35	1.17 ÷ 1.37

98

99

100 The same result was shown by Di Nicola et al. [4] who compared pure hydrocarbons with mixtures of  
101 hydrocarbons and CO<sub>2</sub>. Furthermore, CO<sub>2</sub> is unusable at very low temperatures, triple point being at -56.6°C,  
102 and requires high operating pressures, increasing the cost of the refrigeration system.

103 Experimental data on NH<sub>3</sub>/CO<sub>2</sub> cascade refrigeration systems have been collected e.g. by Bingmin et  
104 al. [1] and by Dopazo and Fernandez-Seara [9]. A comparison between these data and other experimental  
105 results on a R134a/CO<sub>2</sub> cascade system (Sanz-Kock et al. [10]) is shown in Fig.1. Once again, NH<sub>3</sub> seems to  
106 be a preferable option for the high temperature cycle. Ammonia does pose safety problems, but the  
107 refrigeration industry has been using it from the very beginning and has acquired the due experience for  
108 managing any possible risk. Ammonia is commonly included among the “natural” refrigerants and is  
109 receiving an increasing attention from many global players in the refrigeration area [11]. Furthermore, in a  
110 cascade system ammonia may be confined to a restricted part of the plant.

111

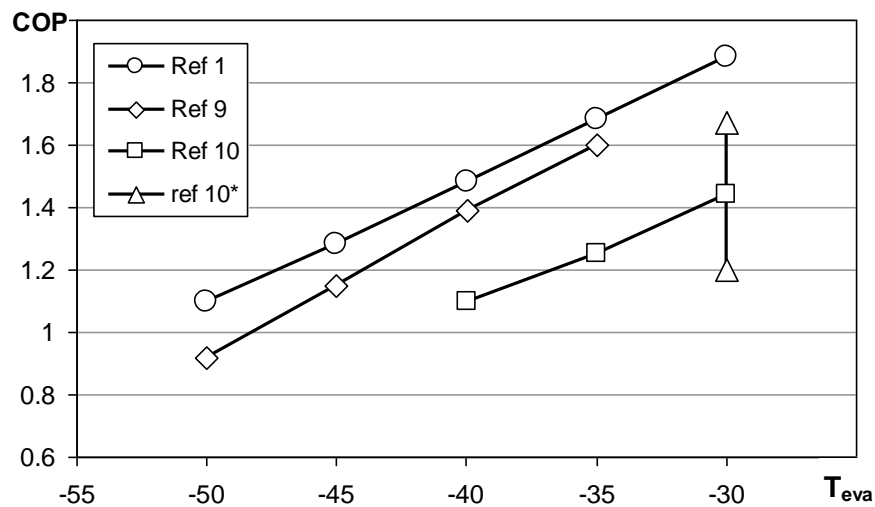

112

113 Fig. 1 – Experimental data from the literature on cascade refrigeration systems

114 Ref. [1]: Bingmin et al.; NH<sub>3</sub>/CO<sub>2</sub>; T<sub>cond</sub> = 40°C; Ref. [9]: Dopazo, Fernandez-Seara; NH<sub>3</sub>/CO<sub>2</sub>, T<sub>cond</sub> = 30°C;

115 Ref. [10]: Sanz-Kock et al.; R134a/CO<sub>2</sub>; T<sub>cond</sub> = 40°C; Ref. [10]\*: same with T<sub>cond</sub> = 30-50°C

116

## 117 1.2 Air cycle

118 A further option for the low-temperature working fluid is air, which may be used in an inverse Brayton  
119 cycle. This cycle has been extensively analysed in various configurations and under different evaluation

120 approaches. Zhang et al. [12] developed an irreversible model and compared the optimal performance of a  
 121 regenerative cycle with that of a simple Brayton cycle. Chen et al. [13] derived a general expression for the  
 122 exergetic efficiency of a regenerated air refrigerator, whereas Ust [14] based his cycle optimization on an  
 123 ecological coefficient of performance (ECOP). Obvious advantages of air as a refrigerant are absolute  
 124 environmental and operational safety. Air is available everywhere at no cost, which has prompted its use as  
 125 working fluid in many devices from the early stages of civilization, immediately after water [15]. Not  
 126 surprisingly, among the first refrigeration systems we find the air machine patented by John Gorrie that dates  
 127 back to the first half of the 19<sup>th</sup> century and had a good success until the introduction of synthetic refrigerants  
 128 [16]. Perishable goods are normally stored in air, so that this same air can be used as working fluid by  
 129 opening the cycle on the cold side (**high pressure cycle** – Fig. 2a), whence the low temperature heat  
 130 exchanger is eliminated. Alternatively, we may use the ambient air as working fluid, eliminating the high  
 131 temperature heat exchanger (**low pressure cycle** – Fig. 2b).

132 Grazzini and Milazzo [17] have shown that, in both cases, an open cycle yields a significant increase  
 133 in efficiency, but the low pressure configuration of Fig.2b is somewhat better. On the other hand, the high  
 134 pressure scheme of Fig. 2a has the major advantage of eliminating the cold heat exchanger which, when  
 135 operated below 0°C, is prone to frost accumulation.

136

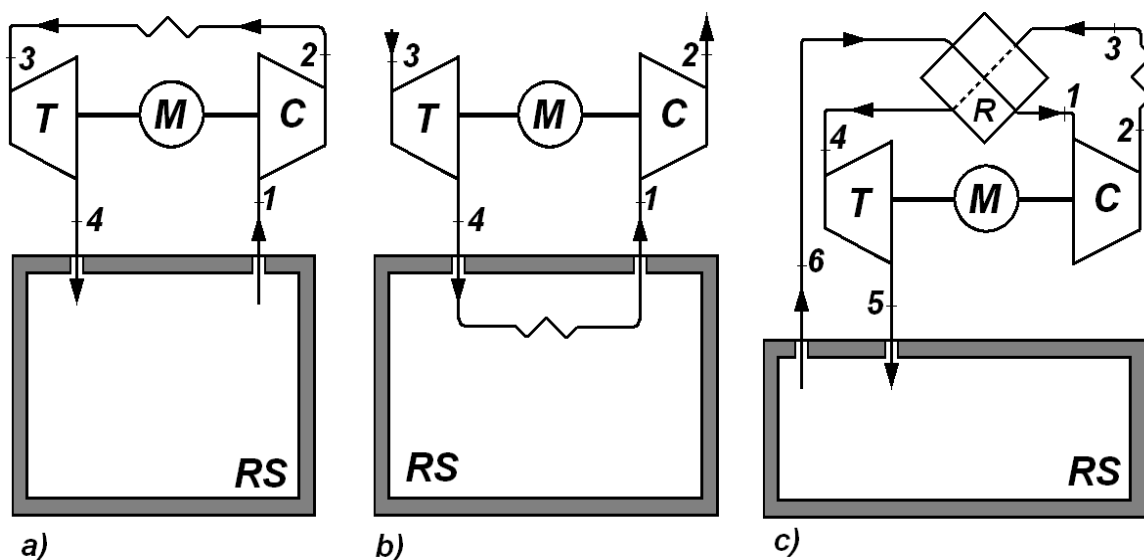

137

138 Figure 2. Inverse Brayton cycles; a) high pressure; b) low pressure; c) regenerated

139 M: electric motor; C: compressor; T: turbine; R: regenerator, RS: refrigerated space.

140

141 The inevitable ingestion of the air humidity causes water condensation and eventually icing in the cold  
142 sections of the system, but the ice particles are formed within the air stream and, as far as they are small, they  
143 move with the air flow, instead of sticking on a cold surface which must be periodically defrosted. The ice  
144 particles can be captured, allowing some humidity control.

145 As far as the residual air velocity at turbine exit is sufficient, even the electric fan that normally  
146 circulates the cold air within the cell (and adds a further electric and thermal load) may be eliminated.

147 The inclusion of a regenerative heat exchanger (Fig. 2c), increases efficiency and reduces the  
148 performance gap between the high and low pressure configuration as shown by Giannetti and Milazzo [18].  
149 This component plays a crucial role in the thermodynamic optimization of the whole system, as will be  
150 shown later.

151 A cascade configuration employing an inverse Brayton as the bottom cycle was suggested by Nobrega  
152 and Sphaier [19] or Elsayed et al. [20], who used a desiccant top cycle. However, to the authors' knowledge,  
153 a cascade of a standard vapour compression cycle and an open inverse Brayton was not discussed in previous  
154 literature, and the integration of these two well-established technologies could be useful to overcome some  
155 of their downsides for a cold store application. The present proposal may be near to market application and  
156 worth of a detailed analysis in terms of design parameters and expected performance. Additionally, the effect  
157 of the phase change of the humidity carried from the air stream circulating within the Brayton cycle is  
158 accounted for in the present modelling effort. The air expansion is reconstructed as a series of equilibrium  
159 states to accurately predict the conditions of the air at the outlet of the expander, which can considerably  
160 deviate from the results obtained for an ideal-gas behaviour. An accurate prediction of the outlet stream  
161 properties in the cold store is critical for an accurate design and optimization of the specific plant. Moreover,  
162 ice separation from the expanding air stream represents a promising alternative to the traditional defrosting  
163 process of aero-evaporators used in cold stores and an evaluation of its potential may be useful.

164

165

## 2. SYSTEM ANALYSIS

166 From a practical point of view, an air cycle refrigeration system may be fairly simple, with compressor and  
167 turbine on a single shaft, driven by a high speed electric motor. Magnetic bearings reduce friction and allow

168 a completely oil-free operation. These concepts are well proven by state-of-the-art centrifugal compressors  
169 which are gaining an increasing market share in many refrigeration applications. The avoidance of a closed  
170 cycle (which could present fluid leakage) increases reliability. Highly efficient compressor, turbine and heat  
171 exchangers are required in order to achieve acceptable COP. The residual efficiency gap with respect to  
172 vapour compression plants must be evaluated on a system basis and over a seasonal operating period that  
173 includes defrosting cycles.

174         Regeneration, i.e. internal heat exchange between the warm air on the high-pressure side of the cycle  
175 and the cold air on the low-pressure side (Fig 2c), allows to overcome the constraint that links the  
176 compression ratio of the simple cycle to the temperature range to be covered.

177         The approach featuring a high pressure, regenerated cycle with single-stage compression is confirmed  
178 by a refrigeration system named “Pascal Air”, manufactured in Japan by Mayekawa [21] and a similar  
179 system developed by Mitsubishi [22]. Another system, the “AIRS50”, featuring a staged compression [23]  
180 was developed by Kajima Inc. and later by Earthship Ltd. and reached a pre-commercial stage of  
181 development, but is no longer available.

182         In the case of a food storage facility, a loading/shipping dock is common everywhere and absolutely  
183 necessary in humid and warm climates. The benefits of a refrigerated loading dock are [24]:

- 184         - The refrigeration load in the low-temperature storage (where the energy demand per unit capacity is  
185             higher) is reduced;
- 186         - A lower amount of humid air is infiltrated in the low-temperature area, reducing ice formation;
- 187         - Refrigerated products held on the dock for loading/shipping maintain their quality;
- 188         - Products packaging, equipment and floor areas stay drier, increasing goods quality, system reliability  
189             and operators’ safety.

190         The loading dock (*LD*) is normally kept around 5°C. The combined need for a low temperature  
191 refrigerated space and intermediate temperature loading dock may be favourably satisfied by a cascade  
192 refrigeration concept that has an intermediate heat exchanger between the two cycles.

193         A hybrid vapour compression / inverse Brayton cascade system may be envisaged as follows (Fig. 3):  
194 the top cycle 7-8-9-10 could be any high temperature vapour compression system, featuring a compressor *C*,  
195 a condenser *K*, an expansion valve *EV* and two evaporators *E*<sub>1</sub> and *E*<sub>2</sub>. The first evaporator refrigerates the



196 loading dock *LD*, while the second couples the vapour compression and the inverse Brayton cycle, cooling  
 197 down the hot compressed air between points 2 and 3. The regenerator further cools the air flow between  
 198 points 3 and 4. The expansion brings the air back to ambient pressure and produces the minimum system  
 199 temperature at point 5. The exhaust air 6 from the refrigerated space *RS* is warmed up in the regenerator  
 200 before entering the compressor in 1. Auxiliary components (e.g. liquid receiver at condenser exit) and other  
 201 practical issues (load control, etc.) are not included in this analysis, which is mainly devoted to  
 202 thermodynamics for a preliminary system design and screening of its potential.

203

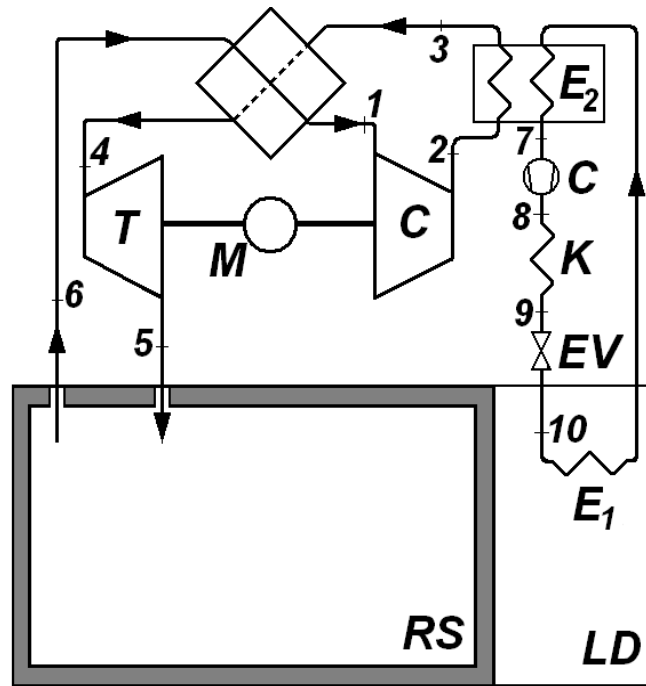

204

205

206

## 207 2.1 Thermodynamic modelling

208 The system efficiency may be expressed by a coefficient of performance defined as:

$$209 \quad COP = \frac{Q_{f-RS} + Q_{f-LD}}{W_B + W_{VC} + W_{aux}} \quad (1)$$

210 where  $Q_f$  = cooling load [kW],  $W_B$  = input power for Brayton cycle [kW],  $W_{VC}$  = input power for vapour  
 211 compression cycle,  $W_{aux}$  = auxiliary power input (condenser fan, etc.).

212 The corresponding thermodynamic cycles are shown on a  $Ts$  diagram in Fig. 4 for the preliminary  
 213 design values of the operative parameters listed in Table 2.  
 214

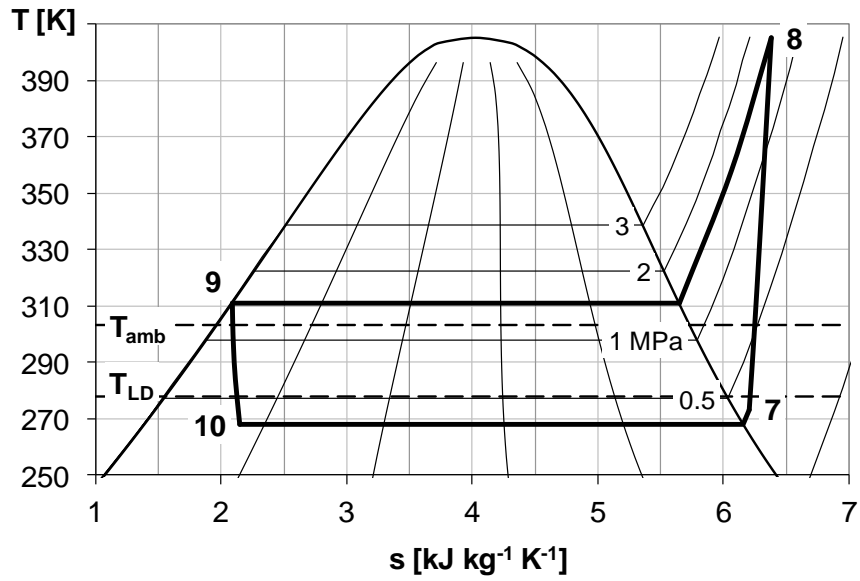

215 a)

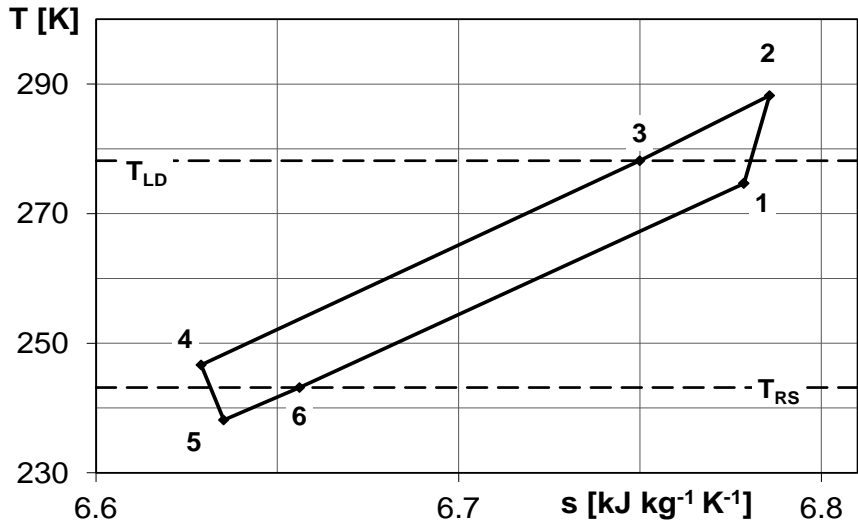

216 b)

217 Figure 4. Temperature-entropy diagrams of the top (a) and bottom (b) cycles

218

Table 2 – Reference system parameters.

Refrigerated store temperature (°C)	$T_{RS}$	-30
Loading dock temperature (°C)	$T_{LD}$	5
Ambient temperature	$T_{amb}$	30
Minimum temperature difference at heat exchangers (°C)	$\Delta T_{eva,min}$	10
<b>Top cycle</b>		
Fluid		NH <sub>3</sub>
Evaporation temperature (°C)	$T_{10}$	-5
Condensation temperature (°C)	$T_9$	40
Superheating at evaporator (°C)	$\Delta T_{sh}$	5
Subcooling at condenser outlet (°C)	$\Delta T_{sc}$	0
Cooling capacity (kW)	$Q_{f-VC}$	103
Input power (kW)	$W_{VC}$	26.5
Fluid temperature at compressor outlet (°C)	$T_8$	132
<b>Air cycle</b>		
Temperature difference between inlet cold air and store (°C)	$\Delta T_{5,6}$	10
Specific heat ratio (air)	$k$	1.4
Regenerative heat exchanger effectiveness	$\varepsilon_R$	0.9
Compression efficiency	$\eta_C$	0.85
Expansion efficiency	$\eta_T$	0.85
Combined mechanical and electrical efficiencies	$\eta_{mech}\eta_{el}$	0.9

220

221

222

223

224

225

226

227

228

229

230

231

The high temperature cycle is calculated using the selection software available at the compressor manufacturer website (<https://www.bitzer.de/websoftware/Calculate.aspx> [25]). NH<sub>3</sub> is assumed as the working fluid. The compressor performance and the working cycle are specified according to EN 12900. The selected compressor is an open, reciprocating unit with 6 cylinders, operating at 50 Hz (Bitzer W6FA). The performance of the top cycle is summarized in Fig. 5 for two evaporation temperatures. Note that this temperature is related to the loading dock temperature and hence is not used as a design parameter in this analysis. The conservative value  $T_{eva} = -5^\circ\text{C}$  (i.e.  $10^\circ\text{C}$  temperature difference between evaporation and loading dock temperature) is assumed hereafter. The  $Ts$  diagram in Fig. 4a is calculated by NIST REFPROP [26] functions.

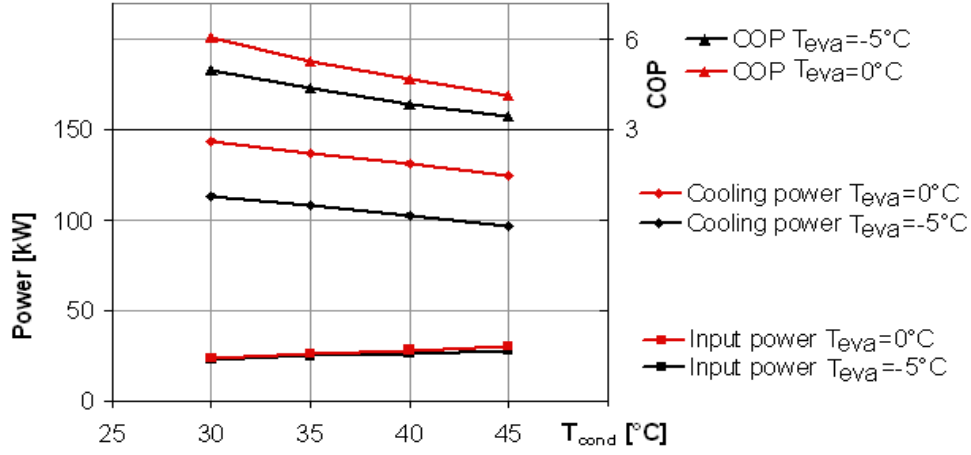

Fig. 5. High temperature cycle performance

232

233

234

235

236

237

238

239

240

241

242

243

244

245

246

Losses within compressors and turbine are accounted for by isentropic efficiencies:

247

$$\eta_C = \frac{W_{C-is}}{W_C}; \quad \eta_T = \frac{W_T}{W_{T-is}} \quad (2)$$

248

249

When the compressor and expander are assembled on a single shaft, the electric motor of the Brayton cycle consumes a power

250

$$W_B = \frac{W_C - W_T}{\eta_{mech}\eta_{el}} \quad (3)$$

251 The regenerator effectiveness  $\varepsilon_R$ , neglecting the specific heat variation, is given by:

$$252 \quad \varepsilon_R = \frac{T_3 - T_4}{T_3 - T_6} = \frac{T_1 - T_6}{T_3 - T_6} \quad (4)$$

253 Cycle point numbering is specified in Fig. 4.

254 The regenerator inlet temperatures are  $T_6 = T_{RS}$  and  $T_3$ , which is fixed by setting a minimum  
 255 temperature difference between air flow and evaporating fluid temperature  $T_{10}$ . The inverse Brayton cycle is  
 256 hence calculated as follows (cycle points are numbered as in Fig. 2):

$$257 \quad T_5 = T_{RS} - \Delta T_{5-6}; \quad T_3 = T_{10} + \Delta T_{\min}; \quad T_4 = T_3 - \varepsilon_R(T_3 - T_6); \quad T_1 = T_6 + \varepsilon_R(T_3 - T_6) \quad (5)$$

258 Temperature  $T_2$  is a function of the compression ratio  $\pi = P_2 / P_1$ :

$$259 \quad T_2 = T_1 \left[ 1 + \frac{1}{\eta_c} \left( \pi^{\frac{k-1}{k}} - 1 \right) \right] \quad (6)$$

260 The pressure ratio is obtained from a simulation of the expansion 4-5 accounting for ice formation.  
 261 The transformation is reconstructed as a series of equilibrium states, iteratively calculating the inlet condition  
 262 that gives the required outlet temperature after a “humid expansion” process, which accounts for the possible  
 263 phase-change of the vapour. Pressure losses in the heat exchangers being neglected, compression ratio and  
 264 expansion ratio are equal. The adopted method for the calculation of  $\pi$  accounts for the deviation of the real  
 265 expansion process from the ideal adiabatic-isentropic transformation of the humid air by means of the  
 266 expansion efficiency defined in eq. (7).

$$267 \quad \eta_T = \frac{J_4 - J_5}{J_4 - J_{5is}} \quad (7)$$

268 where point  $5_{is}$  is defined with reference to the thermodynamic state at turbine inlet ( $s_{5is}=s_4$ ). Enthalpy  
 269 and entropy of the humid air are calculated as follows:

$$270 \quad J = h_{air} + x_4 h_v \quad (8)$$

$$271 \quad s = s_{air} + x_4 s_v \quad (9)$$

272 where  $x$  is the absolute humidity of the working air stream. Water enthalpy and entropy are evaluated  
 273 assuming ideal gas behaviour until saturation, whereas after saturation they are given, respectively, by eq.s  
 274 10 and 11.

$$275 \quad h_v = h_{v,sat} - \left(1 - \frac{x_5}{x_4}\right) r \quad (10)$$

$$276 \quad s_v = s_{v,sat} - \left(1 - \frac{x_5}{x_4}\right) \frac{r}{T} \quad (11)$$

277  $r$  being the latent heat of ice formation. When phase change occurs, the total flowrate includes the  
 278 three contributions of ice, vapour and dry air flowrates. If the absolute humidity decreases with respect to the  
 279 preceding step, the difference is taken as the quantity of ice produced. The ice formation is considered as  
 280 instantaneously defined by eq. 12; where the vapour and the ice flowrates change with the local temperature,  
 281 whereas the dry air's flowrate stays constant.

$$282 \quad \dot{m}_{ice} = (x_4 - x_{sat}) \dot{m}_{air} \quad (12)$$

283 The corresponding latent heat release is added to the air enthalpy (eq. 13);

$$284 \quad J = \frac{\dot{m}_{air} h_{air} + \dot{m}_v h_{v,sat} + \dot{m}_{ice} r}{\dot{m}_{air}} \quad (13)$$

285 and a corrected temperature is calculated via NIST functions. Pressure  $P_4$  is calculated by iteratively  
 286 increasing its value, from an initial one that gives the due state (state 5) at the end of an isentropic expansion,  
 287 until the eq. 7 is verified with a preset tolerance.

288 Once the compression ratio is known, all properties can be calculated throughout the cycle. The  
 289 amount of ice collected is define by eq. 12 and the cooling capacity is

$$290 \quad Q_{f-RS} = \dot{m}_{air} (J_6 - J_5) \quad (14)$$

291

## 292 2.2 Heat Transfer surfaces

293 The cascade system presented eliminates the low temperature heat transfer surface, but features an air-  
 294 refrigerant heat exchanger between the top and bottom cycles, and introduces an air-air regenerator, which  
 295 might suffer from high pressure drops. A good design requires a compromise between volume of the heat

296 exchanger and related pressure drops. Considering the definition from Kays and London [29], the evaporator  
 297 has effectiveness,

$$298 \quad \varepsilon_{eva} = \frac{Q_{eva}}{Q_{max}} = \frac{Q_{eva}}{C_{min} (T_2 - T_{10})} = \left( 1 + \frac{\Delta T_{eva,min}}{T_2 - T_{LD}} \right)^{-1} \quad (15)$$

299 where, due to the refrigerant phase-change occurring on the vapour compression cycle side, the  
 300 minimum thermal capacity  $C_{min}$  pertains to the air flux circulating in the inverse Brayton cycle. Referring to  
 301 eq.s 4-6,

$$302 \quad \varepsilon_{eva} = \left( 1 + \frac{\Delta T_{eva}}{\left[ T_{RS} + \varepsilon_R (T_{LD} - T_{RS}) \right] \left\{ 1 + \frac{1}{\eta_C} \left[ \frac{(1 - \varepsilon_R)(T_{LD} - T_{RS}) + \Delta T_{5-6}}{(T_{RS} - \Delta T_{5-6}) \eta_T} \right] \right\} - T_{LD}} \right)^{-1} \quad (16)$$

303 Equation (16) highlights the dependence of the effectiveness of the cascade heat exchanger  
 304 (evaporator of the top cycle) on the effectiveness of the regenerative heat exchanger of the Brayton cycle.  
 305 Introducing the general expression of the effectiveness of a counter-current flow heat exchanger as a function  
 306 of the number of transfer unit  $NTU = \beta S / C_{min}$ ,

$$307 \quad \varepsilon = \frac{1 - e^{-NTU(1 - C_{min}/C_{max})}}{1 - \frac{C_{min}}{C_{max}} e^{-NTU(1 - C_{min}/C_{max})}} \quad (17)$$

308 the total transfer surface required by the low temperature cycle may be written as a function of the  
 309 regenerator effectiveness (Fig. 7). Specifically,  $C_{min} / C_{max}$  being 0 for the cascade Heat exchanger and 1 for  
 310 the regenerative heat exchanger, equation (17) yields:

$$311 \quad \varepsilon_R = \frac{NTU}{1 + NTU} \quad , \quad \varepsilon_{eva} = 1 - e^{-NTU} \quad (18)$$

312 A higher regenerator effectiveness  $\varepsilon_R$  reduces the load at the cascade heat exchangers  $\dot{m}_{air} c_p (T_2 - T_3)$  for  
 313 the same air flowrate and, consequently, the size of the heat exchanger (Fig. 7) required to achieve a target  
 314 minimum temperature difference  $\Delta T_{eva,min}$ .

315

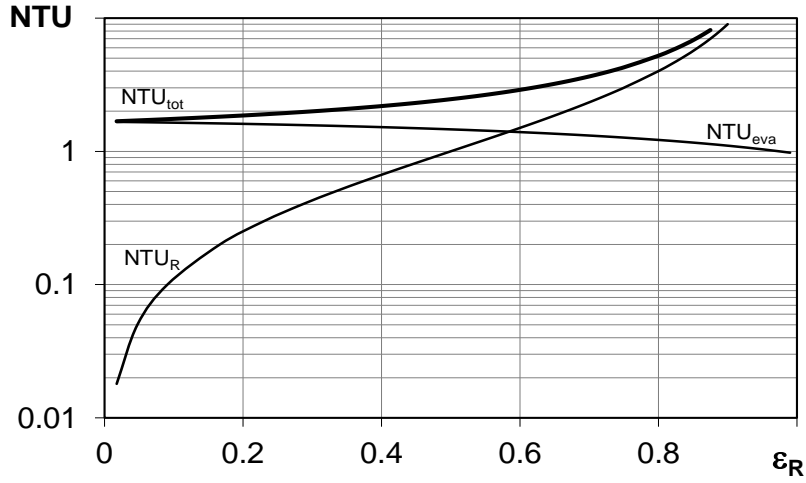

Figure 7.  $NTU-\varepsilon_R$  diagram of the bottom cycle

316

317

318

319 A higher regenerator effectiveness reduces also the compression ratio required for a given operative  
 320 temperature difference  $T_{LD}-T_{RS}$ , therefore increasing cycle efficiency.

321 In the regenerator, the hot and cold flows have practically equal thermal capacities and the driving  
 322 temperature difference is approximately constant along the axial length of the heat exchanger  $L$  (eq. 19).

$$323 \quad Q_R = \dot{m}_{air} c_p (T_{LD} - T_4) = \dot{m}_{air} c_p \varepsilon_R (T_{LD} - T_{RS}) = \int_0^L \beta \eta \alpha A \Delta T dl = \beta \eta \alpha A \Delta T L \quad (19)$$

324 where  $\beta$  is the convective heat transfer coefficient,  $\alpha$  the value of transfer area per unit volume,  $\eta$  is  
 325 the global effectiveness of the exchange surface and  $A$  is the frontal flow area. Neglecting the wall thermal  
 326 resistance, the solid surface temperature  $T_p$  corresponds to the mean value between the two streams,

$$327 \quad |T - T_p| = \frac{\varepsilon_R (T_{LD} - T_{RS})}{2} = \Delta T \quad (20)$$

328 Accordingly, by introducing the mass velocity of the air flow  $G_{air}$  circulating in the low temperature  
 329 cycle,

$$330 \quad \varepsilon_R = \frac{\beta \eta \alpha L}{2G_{air} c_p + \beta \eta \alpha L} \quad (21)$$

331 The heat transfer coefficient  $\beta$  refers to the experimental correlation of Colburn factor reported by  
 332 Kays and London [29] and  $\eta$  is assumed to be 0.77 for realistic values of convective heat transfer coefficient



333 and usual fin geometry. The same reference gives the calculation procedure for the global pressure losses  
 334 (inlet boundary-layer-separation drop, distributed losses through the passages and outlet recovery)

335

336 Table 3 - Possible features of a counter-flow regenerator with  $\varepsilon = 0.9$ .

Transfer surface per unit volume ( $\text{m}^{-1}$ )			$\alpha$	899
Regeneration effectiveness			$\varepsilon_R$	0.9
Global effectiveness of the exchange surface			$\eta$	0.77
Case 1			Case 2	
Mass velocity ( $\text{kg}\cdot\text{m}^{-2}\text{s}^{-1}$ )	$G_{air}$	13.7	Mass velocity ( $\text{kg}\cdot\text{m}^{-2}\text{s}^{-1}$ )	$G_{air}$ 6.37
Pressure drops hot side (kPa)	$\Delta P$	2.59	Pressure drops hot side (kPa)	$\Delta P$ 0.64
Pressure drops cold side (kPa)	$\Delta P$	4.15	Pressure drops cold side (kPa)	$\Delta P$ 1.02
Axial length (m)	$L$	2.00	Axial length (m)	$L$ 1.20
Frontal area ( $\text{m}^2$ )	$A$	0.95	Frontal area ( $\text{m}^2$ )	$A$ 2.04

337

338

339 The regenerator features are listed in Table 3, for a target effectiveness of 0.9. This tentative sizing of  
 340 the regenerator supports the feasibility of the selected design parameters shown in Table 1, where the  
 341 assumed efficiency  $\varepsilon_R$  is conservative if compared to the claimed value ( $\varepsilon_R \sim 95\%$ ) of the counter-flow  
 342 regenerator featured by the 30 kW commercial product ‘‘Pascal Air’’ operating at design condition (NEDO  
 343 documents [28]).

344 Case 1 features a smaller frontal cross-section area (higher mass velocity) and overall volume, but has  
 345 higher pressure drop. Case 2 has a length  $L=1.2$  m and the volume increases, but the pressure drop is reduced  
 346 significantly ( $\Delta P=1.02$  kPa). Therefore, the pressure drops of the regenerative heat exchanger are  
 347 preliminarily considered to be negligible when compared to the overall pressure ratio  $\pi$  of the bottom cycle  
 348 and disregarded with respect to the whole system performance.

349

### 3. RESULTS AND DISCUSSION

350 As a first step, we consider the cascade system serving the refrigerated space  $RS$  without any  
 351 additional cooling load due to the loading dock. In this case, as all the cooling power is delivered at the

352 minimum temperature, the system operates in its most severe condition. Assuming the reference parameter  
353 values listed in Table 2, the system performance is summarized in Table 4.

354 In this configuration the compression ratio turns out to be  $\pi=1.26$ , yielding a very low temperature rise  
355 within the compressor ( $T_1=1.5^\circ\text{C}$ ;  $T_2=23.6^\circ\text{C}$ ). With respect to state-of-the-art centrifugal compressors used  
356 for refrigeration,  $\pi$  is lower by one order of magnitude. This means that the turbine and compressor may  
357 have a very simple design and fairly high efficiency, e.g. they may both have a single axial stage.  
358 Furthermore, this temperature increase copes well with the superheating at the exit of the cascade heat  
359 exchanger (evaporator  $E_2$  in Fig. 2), yielding acceptable heat transfer irreversibility.

360

361 Table 4 - Performance parameters with 100% cooling capacity given to *RS*.

Brayton cycle mass flow rate ( $\text{kg}\cdot\text{s}^{-1}$ )	$\dot{m}_{air}$	5.49
Cooling capacity (kW)	$Q_{f,RS}$	57.6
Power consumption, vapour compression cycle (kW)	$W_{VC}$	26.5
Power consumption, Brayton cycle (kW)	$W_B$	50.1
Coefficient Of Performance	COP	0.75
Water vapour subtracted ( $\text{kg}\cdot\text{h}^{-1}$ )	$\dot{m}_{H_2O}$	3.06

362

363

364 Note also the amount of vapour subtracted to the *RS*, which highlights the significant de-  
365 humidification potential of this system. Obviously the details of the ice-capturing device are outside the  
366 scope of this paper and must be tailored on the quantity and quality (particle dimension, density, etc.) of the  
367 removed ice by a careful experimental analysis.

368 The COP value shown in Table 4 may be compared with the data listed in Table 1 and Fig. 1.  
369 However, these values should be decreased to account for internal loads related to evaporator fans and  
370 defrosting. According to ASHRAE Refrigeration Handbook [24], these contributions may amount to 15% of  
371 the total cooling load. This power penalty enters in the COP calculation both as a reduction of cooling  
372 capacity and as an increase of energy consumption. Another term of comparison can be a stand-alone

373 Brayton cycle covering all the temperature range between ambient and refrigerated space. In this case the  
374 COP would fall to 0.55.

375 As the cooling power delivered to the loading dock increases, the cascade system shows a relentless  
376 performance improvement, up to a COP of 1.4 when half of the cooling capacity from the top cycle is  
377 delivered at the temperature level of the LD. Obviously the aforementioned results are strictly dependent on  
378 the parameters chosen for the simulation.

379

### 380 3.1 – Effect of compressor and turbine efficiency

381 If the compressor and/or turbine efficiency are improved or decreased, the system COP is heavily  
382 influenced, as shown in Fig. 8 for  $Q_{LD}/Q_{VC} = 0.25$ . In general, for given cold store and loading dock  
383 temperatures, higher expander and compressor efficiency are associated to lower required pressure ratios.  
384 The analytic expression of the dependence of the COP of the Brayton cycle on the polytropic efficiency of  
385 the turbine and the compressor has been described by Giannetti and Milazzo in [18].

386 The inclined surface drawn in Fig. 8 is practically symmetric, i.e. the effect of improving the  
387 compressor or the turbine is equally important. This result could change if the effect of pressure losses  
388 through heat exchangers, piping and ice filter were included in the analysis. A further pressure reduction may  
389 be due to the need to introduce the air within the *RS* at a suitable speed in order to promote circulation.

390

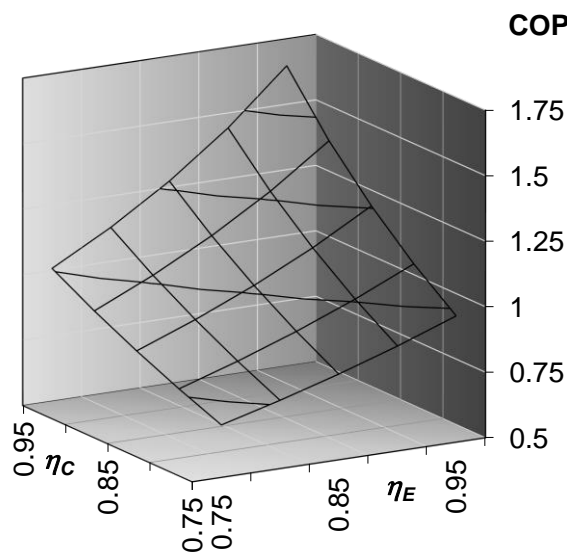

391

392 Figure 8. Cascade system COP v/s compressor and turbine efficiencies ( $Q_{LD}/Q_{VC} = 0.25$ )

393

### 394 3.2 Effect of Regenerator effectiveness

395 The regenerator effectiveness  $\varepsilon_R$  also has a significantly beneficial influence, especially at high values,  
396 as shown in Fig. 9 for the same value of  $Q_{LD}/Q_{VC}$ . *Ceteris paribus*, a higher  $\varepsilon_R$  reduces the gap between the  
397 source temperature and the inlet temperature to the turbine or compressor, lowering the compression ratio  $\pi$   
398 required for a specific application case.

399

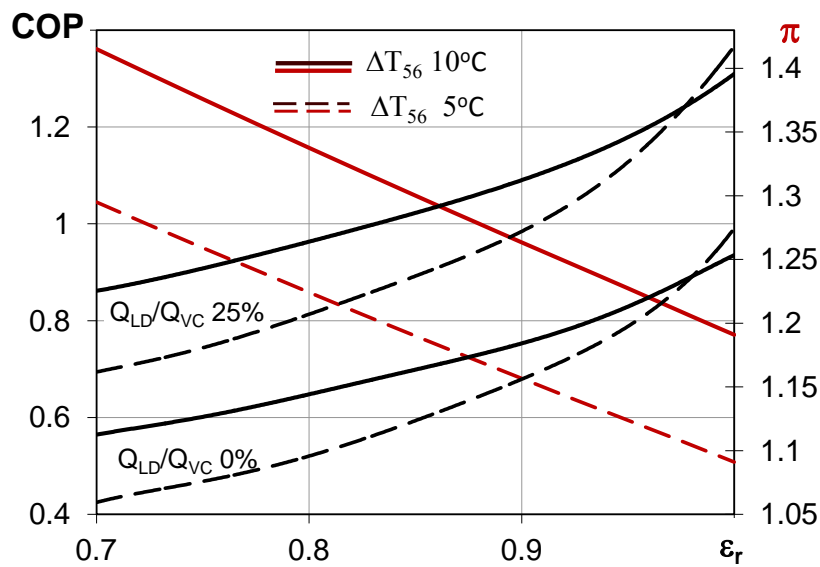

400

401 Figure 9. Cascade system COP v/s regenerator effectiveness

402

403 Increasing the regenerator surface is probably the simplest way to improve the air cycle performance,  
404 though a great care must be taken to avoid a corresponding increase in pressure loss [18]. The high reference  
405 value assumed for effectiveness has been proven to be feasible in terms of heat exchange surface by the  
406 conceptual design reported in the previous section. The same can be said of evaporators and condenser,  
407 where rather low temperature differences have been imposed.

408

### 409 3.3 Effect of cold air inlet temperature

410 Another significant parameter is the temperature difference between refrigerated space and air inlet  
411 ( $\Delta T_{5-6}$ ). Figure 10 shows how a reduction of this temperature difference yields a corresponding decrease of  $\pi$ .

412 A higher regenerator effectiveness better matches lower  $\Delta T_{5-6}$  and, conversely, lower values of the latter  
 413 parameter turn out to be beneficial when a highly efficient regenerator is not available. The effect of  $\Delta T_{5-6}$  on  
 414 the system COP is also visible in Fig. 10, which shows a well-defined maximum for each value of  $Q_{LD}/Q_{VC}$ .  
 415 Specifically, the value of  $\Delta T_{5-6}$  yielding the maximum performance increases as the regenerator effectiveness  
 416 is reduced. The same behaviour was also shown in terms of air flow rate or specific cooling capacity in [18].  
 417

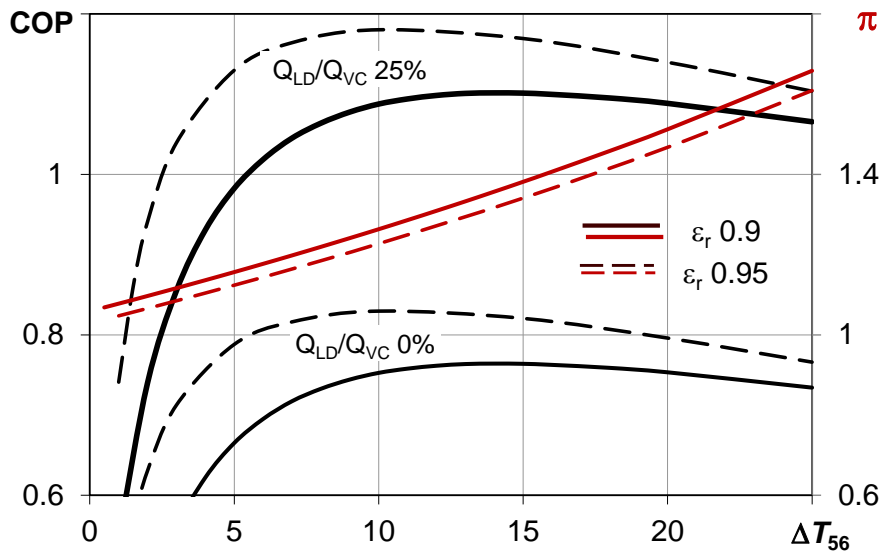

418

419

420

421 Every refrigeration system faces finite capacity heat sources that can be approximated to isothermal  
 422 sources with different degrees of approximation. However, some applications, counter current products  
 423 refrigeration on contact belt freezers for instance, require large temperature variations of the low temperature  
 424 heat source. In these cases, if the system is designed to deliver the refrigerant in counter-current to the belt  
 425 movement, a higher  $\Delta T_{5-6}$  could indeed minimize heat transfer irreversibility and lead to higher overall  
 426 system efficiency.

427 As the temperature difference increases (i.e. the air flow decreases), so does the difference in absolute  
 428 humidity between inlet flow and *RS* air, enhancing the drying capability of the system. On the other hand, a  
 429 lower flowrate directly implies a lower rate of humid air processed within the Brayton cycle. Figure 11  
 430 highlights a maximum of the humidity removal rate (i.e. amount of ice formed per unit time) at a specific

431 value of  $\Delta T_{5-6}$ . If the cold-store temperature decreases from -30 to -50, the maximum removal rate moves to  
432 the right.

433

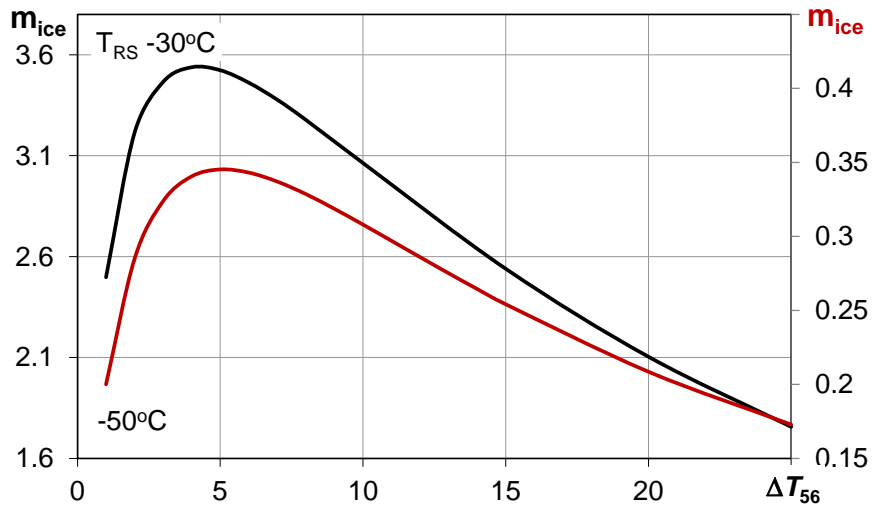

434

435 Figure 11. Rate of humidity extracted for different cold-store temperatures

436

#### 437 3.4 Effect of inter-cooled compression

438 As already mentioned, the efficiency gap of the Brayton cycle decreases at lower cold space  
439 temperatures. Therefore, further calculations have been made for values below  $-30^\circ C$ . In this case, an inter-  
440 cooled compression could be advantageous in order to keep the compression ratio and compressor exit  
441 temperature at low values (Fig. 13). A possible scheme is shown in Fig. 12.

442

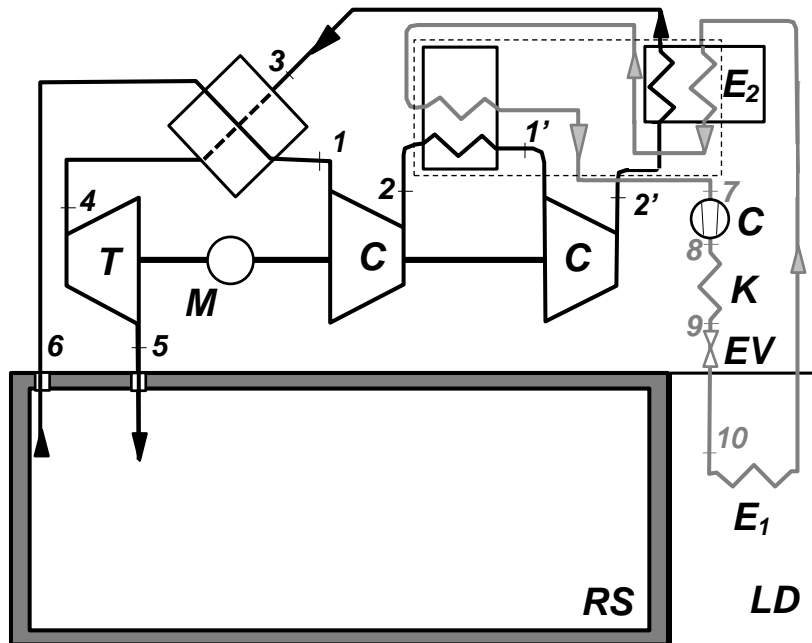

443

444 Figure 12. Scheme of the cascade system featuring inter-cooled staged compression on the Brayton cycle

445

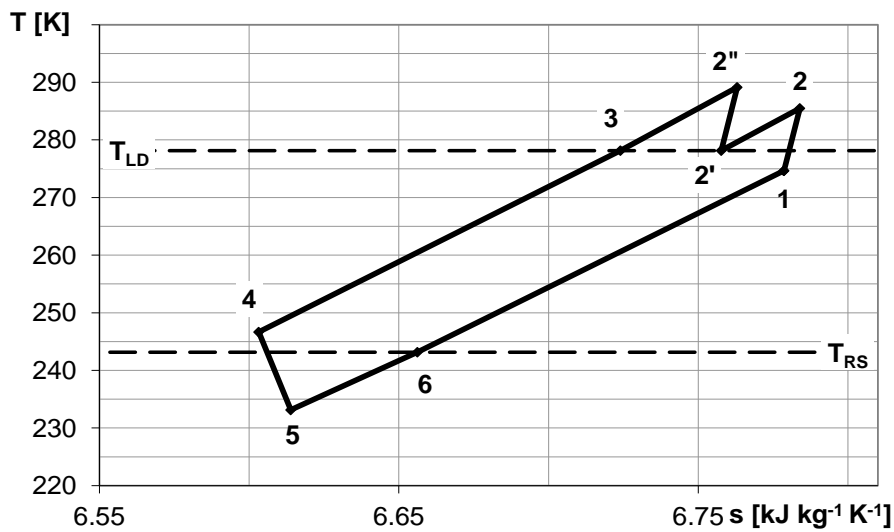

446

447 Figure 13. Temperature-entropy diagram for Brayton cycle with inter-cooled compression ( $\Delta T_{5,6} = 7^\circ C$ )

448 When compared with single stage compression, the intercooled configuration copes with higher  
 449 temperature variation at the cold storage, i.e. lower air flowrates. As shown in Fig.14 the COP gain is not  
 450 dramatic, but may become worth the effort at high values of  $\Delta T_{5,6}$ .

451

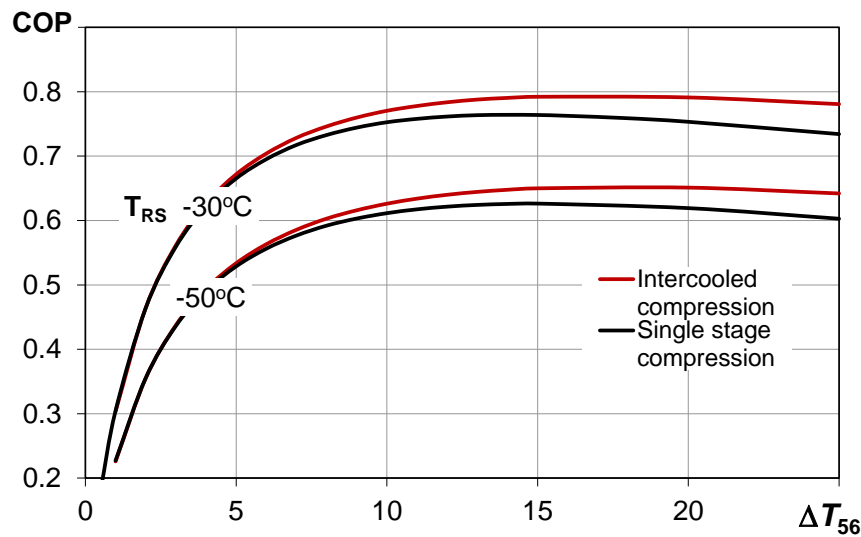

452

453 Figure 14. COP as a function of  $\Delta T_{5-6}$  for various cold space temperatures, with (grey lines) and without  
 454 (black lines) intercooling ( $Q_{LD}/Q_{VC} = 0\%$ )

455

### 456 3.5 Effect of cold space temperature

457 When the cold space temperature is used as a parameter, the comparison between conventional  
 458 systems (Table 1, Fig. 1) and the one presented here (continuous lines in Figure 15) becomes clearer:  
 459 accounting for COP losses due to defrosting and cold air circulation of the conventional systems the  
 460 performance of the cascade Brayton system becomes competitive at low storage temperatures. A pure  
 461 Brayton cycle is shown for comparison (dashed line in Fig. 15).

462 Systems requiring very low temperature, e.g. fast freezing of food, may represent a promising  
 463 application for the proposed scheme. Air, in this case, may be the sole option, as shown e.g. by the  
 464 experiments performed at  $-124.5^\circ\text{C}$  by Hongli et al. [30].

465



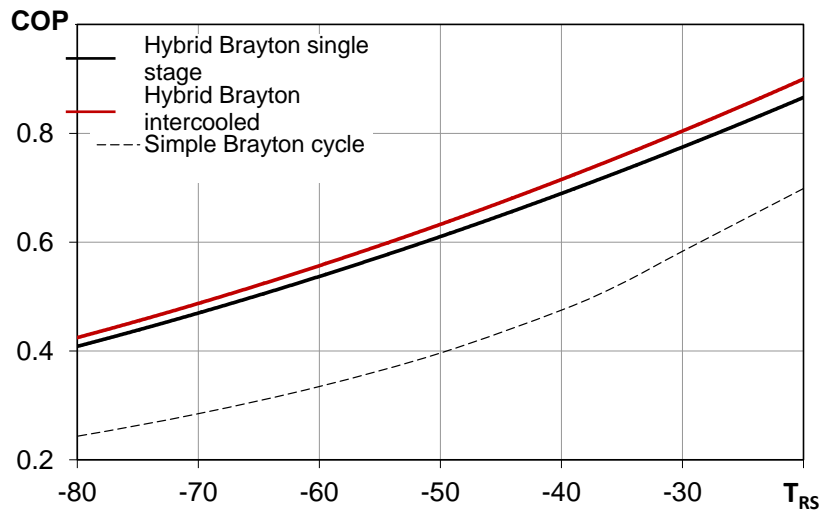

Figure 15. COP as a function of  $T_{RS}$  for various system configurations

#### 4. CONCLUSIONS

A zero-GWP cascade configuration featuring an ammonia vapour compression cycle at the top and an inverse Brayton cycle at the bottom is proposed for cold store applications. The use of air as a working fluid in the bottom cycle eliminates the evaporator and the related thermal loads due to defrosting, as well as to the fan for air circulation. In a cascade configuration the regenerated Brayton cycle is characterized by a very low compression ratio, hence enabling the use of simple and highly efficient turbine and compressor. At the same time, this condition yields a lower temperature rise within the compressor and reduces the thermal irreversibility in the cascade heat exchanger.

The top cycle may also serve for loading dock refrigeration. The penalty in terms of COP can be low or even null, as soon as efficient compressor, turbine and regenerator are available. This target is becoming technically feasible as design and manufacturing of turbomachinery and heat exchangers progress. Additionally, as the operating temperature is lowered the efficiency gap with respect to conventional systems decreases or even vanishes, while other fluids (e.g.  $\text{CO}_2$ ) reach their triple point and become unusable.

An optimum value exists for the temperature difference between cold air admission and refrigerated space. Latent load may be handled by an ice capturing device installed at the turbine outlet port.

If the refrigerated space temperature is very low, a staged-intercooled compression may offer a further slight increase in efficiency.

486 The proposed configuration seems promising in terms of safety (low pressure, ammonia used only  
487 outside of the cold space), reliability (no need to defrost, no electric fan in the cold space) and environment  
488 protection (both cycles use “natural” fluids). The system turns out to be readily feasible, given the well-  
489 established background of each of the two integrated refrigeration technologies.

490 As long as the loading dock temperature is moderate (e.g. 5°C as assumed herein), this concept can be  
491 extended by coupling the Brayton cycle with a heat driven refrigeration system, i.e. an absorption or ejector  
492 chiller, in lieu of the electric-driven ammonia cycle. In this way, the electric energy consumed by the  
493 Brayton cycle and the thermal energy for the heat driven chiller could be both produced by a combined heat  
494 and power system (CHP), allowing significant energy savings.

495

496

## ACKNOWLEDGMENT

497 This work has been supported by MIUR of Italy within the framework of PRIN2015 project «Clean  
498 Heating and Cooling Technologies for an Energy Efficient Smart Grid»

499

## REFERENCES

- 500 [1] Bingming, W., Huagen, W., Jianfeng, L., Ziwen, X. 2009, Experimental investigation on the  
501 performance of NH<sub>3</sub>/CO<sub>2</sub> cascade refrigeration system with twin-screw compressor, *Int. J. Refrig.* 32:  
502 1358-1365.
- 503 [2] Kilicarslan A., Hosoz M. 2010, Energy and irreversibility analysis of a cascade refrigeration system  
504 for various refrigerant couples: *Energy Conversion and Management* 51 (12): 2947-2954.
- 505 [3] Lee, T.S., Liu, C.H., and Chen, T.W. 2006, Thermodynamic analysis of optimal condensing  
506 temperature of cascade-condenser in CO<sub>2</sub>/NH<sub>3</sub> cascade refrigeration systems, *Int. J. Refrig.* 29: 1100-  
507 1108.
- 508 [4] Di Nicola. G., Giuliani, G., Polonara, F., Stryjek, R., Arteconi, A. 2011, Performance of cascade  
509 cycles working with blends of CO<sub>2</sub> + natural refrigerants, *Int. J. Refrig.* 34: 1436-1445.
- 510 [5] Aminyavari M., Najafi B., Shirazi A., Rinaldi F. 2014, Exergetic, economic and environmental (3E)  
511 analyses, and multi-objective optimization of a CO<sub>2</sub>/NH<sub>3</sub> cascade refrigeration system, *Applied*  
512 *Thermal Eng.* 65 (1-2): 42-50.
- 513 [6] Nasruddin, Sholahudin S., Giannetti N., Arnas 2016, Optimization of a cascade refrigeration system  
514 using refrigerant C<sub>3</sub>H<sub>8</sub> in high temperature circuits (HTC) and a mixture of C<sub>2</sub>H<sub>6</sub>/CO<sub>2</sub> in low  
515 temperature circuits (LTC), *Applied Thermal Eng.* 104: 96-103.
- 516 [7] Gettu. H.M, Bansal. P.K. 2008, Thermodynamic analysis of an R744-R717 cascade refrigeration  
517 system, *Int. J. Refrig.* 31: 45-54.
- 518 [8] Mosaffa A.H., Garousi Farshi L., Infante Ferreira C.A., Rosen M.A. 2016, Exergoeconomic and  
519 environmental analyses of CO<sub>2</sub>/NH<sub>3</sub> cascade refrigeration systems equipped with different types of  
520 flash tank intercoolers, *Energy Conversion and Management* 117: 442-453.

- 521 [9] Dopazo, J.A., Fernandez-Seara J. 2011, Experimental evaluation of a cascade refrigeration system  
522 prototype with CO<sub>2</sub> and NH<sub>3</sub> for freezing process applications, *Int. J. Refrig.* 34 (1): 257-267.
- 523 [10] Sanz-Kock C., Llopis R., Sánchez D., Cabello R., Torrella E. 2014, Experimental evaluation of a  
524 R134a/CO<sub>2</sub> cascade refrigeration plant, *Applied Thermal Eng.* 73 (1): 41-50.
- 525 [11] [www.ammonia21.com](http://www.ammonia21.com)
- 526 [12] Zhang Y., Chen J., He J., Wu C. 2007, Comparison on the optimum performance of the irreversible  
527 Brayton refrigeration cycles with regeneration and non-regeneration, *Applied Thermal Eng.* 27: 401-  
528 407.
- 529 [13] Chen L., Tu Y., Sun F. 2011, Exergetic efficiency optimization for real regenerated air refrigerators,  
530 *Applied Thermal Eng.* 31: 3161-3167.
- 531 [14] Ust Y. 2009, Performance analysis and optimization of irreversible air refrigeration cycles based on  
532 ecological coefficient of performance criterion, *Applied Thermal Eng.* 29: 47-55.
- 533 [15] Yannopoulos S.I., Lyberatos G., Theodossiou N., Li W., Valipour M., Tamburrino A., Angelakis A.N.,  
534 Evolution of Water Lifting Devices (Pumps) over the Centuries Worldwide, *Water* 2015, 7(9), 5031-  
535 5060.
- 536 [16] Gladstone J., John Gorrie the visionary, *ASHRAE Journal*, December 1998.
- 537 [17] Grazzini G, Milazzo A. 2010, Air cycle air conditioning: analysis of different configurations, *Proc.*  
538 *Sustainable Refrigeration and Heat Pump Technology Conference: 1-8.*
- 539 [18] Giannetti N, Milazzo A. 2014, Thermodynamic analysis of regenerated air-cycle refrigeration in high  
540 and low pressure configuration, *Int. J. Refrig.* 40: 97-110.
- 541 [19] Nóbrega C.E.L, Sphaier L.A. 2012, Modelling and simulation of a Desiccant-Brayton Cascade  
542 refrigeration cycle, *Energy and Buildings*, 55: 575-584.
- 543 [20] Elsayed S.S., Miyazaki T., Hamamoto Y., Akisawa A., Kashiwagi T. 2008, Performance analysis of  
544 air cycle refrigerator integrated desiccant system for cooling and dehumidifying warehouse, *Int. J.*  
545 *Refrig.* 31 (2): 189-196.
- 546 [21] Boone J., Machida A. 2011, Development of air refrigeration system “Pascal Air”. *Proc. 23rd Int.*  
547 *Congr. Refrig., IIF/IIR*: 1597-1605.

- 548 [22] Kikuchi S, Igawa H, Mitsuhashi M, Okuda S, Morii S, Higashimori H. 2005, Development of air cycle  
549 system for refrigeration. *Mitsubishi Heavy Ind. Tech. Rev.* 42: 1-4.
- 550 [23] Gigiel A, Giuliani G, Vitale C, Polonara F. 2006. An open air cycle freezer. *Proc. 7th Gustav*  
551 *Lorentzen Conf. Nat. Work. Fluids, IIF/IIR*: 325-328.
- 552 [24] ASHRAE. 2010, *Handbook - Refrigeration*, American Society of Heating, Refrigeration and Air-  
553 Conditioning Engineers, inc. Atlanta, GA.
- 554 [25] <https://www.bitzer.de/websoftware/Calculate.aspx>
- 555 [26] Lemmon E.W., Huber M.L., McLinden M.O. 2013, *NIST Standard Reference Database 23: Reference*  
556 *Fluid Thermodynamic and Transport Properties-REFPROP, Version 9.1*. National Institute of  
557 Standards and Technology, Standard Reference Data Program, Gaithersburg, Maryland, USA.
- 558 [27] ASHRAE. 2009, *Handbook - Fundamentals*, American Society of Heating, Refrigeration and Air-  
559 Conditioning Engineers, inc. Atlanta, GA.
- 560 [28] NEDO PROJECT SUCCESS STORIES November 2013, *Documents*, エネルギー問題解決に挑む、  
561 空気冷媒でマイナス 60 を実現する超低温冷凍システム (*An ultra-low temperature refrigeration*  
562 *system that realizes minus 60 with air refrigerant, challenging energy problem solution*, Maekawa  
563 *Manufacturing co., Ltd.*)、株式会社前川製作所 (*Mayekawa Co. Ltd.*), Japan (in Japanese).
- 564 [29] Kays W. M. and London A. L. 1964, *Compact Heat Exchangers*, 2nd edition, McGraw-Hill, New  
565 York.
- 566 [30] Hongli Z., Yu H., Liang C. 2009, Experimental study on a small Brayton air refrigerator under -120  
567 °C, *Applied Thermal Eng.* 29: 1702-1706.
- 568