

Advanced Blind Adaptive Multi-User Detector for Communications in Nonstationary Multipath Fading Channel

Enrico Del Re, *Senior Member, IEEE*, Romano Fantacci, *Senior Member, IEEE*, Simone Morosi, *Student Member, IEEE*, and Andrea Pugi

Abstract—This paper deals with an adaptive multi-user detector for direct sequence code division multiple access (DS/CDMA) wireless communication systems, named advanced blind adaptive multi-user detector (ABA-MUD), whose main features are low complexity and joint utilization of time diversity and adaptive blind processing techniques. Differently from known blind adaptive detectors, the proposed scheme achieves remarkable performance even in critical time-varying environments by means of a suitable window reprocessing technique. The ABA-MUD avoids the use of training sequences and only needs knowledge of timing and signature waveform of the desired user, number of active users and a rough evaluation of the signal-to-interference ratio (SIR) for a proper setting of the detection algorithm. Numerical results, shown here in terms of bit error rate (BER), highlight good behavior and remarkable near-far resistance of the proposed ABA-MUD receiver with respect to different alternatives, in particular, in the case of worst fading environments.

Index Terms—Blind adaptive techniques, code division multiple access (CDMA) communications, multi-user detection for wireless communications.

I. INTRODUCTION

THE choice of direct sequence code division multiple access (DS/CDMA) systems for the third-generation wireless communications is the base for the IMT-2000 global standard definition.¹

As it is well known, the benefits of the DS/CDMA technique can be summarized in potential increase of system capacity, ability to support universal frequency reuse, graceful degradation under loaded conditions, soft handoff capability, easy adaptation to variable rate services, low-power flux density emission and, finally, the possibility to use classical time diversity techniques to cope with multipath fading effects. On the other hand, this technique is basically interference limited; that is to say that bit error rate (BER) performance is limited by multiple access interference (MAI). Hence, suitable multi-user detection approaches have to be considered in order to lower this drawback.

Several (multi-user) algorithms have been recently proposed [2]: they significantly improve performance by mitigating the

disadvantages associated with the use of conventional rake receiver [17] but, unfortunately, also increase implementation complexity. As a consequence research activity has been focused on suboptimal approaches: in particular, growing attention has been devoted to adaptive detectors [3]–[6]. This type of detectors is based on the minimization of the mean square error (MSE) and requires for each user the transmission of a training sequence (TS) at the startup and, eventually, also during data transmissions to counteract dramatic environment changes.

In order to avoid TS transmission, Honig *et al.* [1] have proposed in an minimum MSE (MMSE) receiver based on the minimization of the output energy (OE) for contexts characterized by synchronous users and additive white gaussian noise (AWGN). Anyway, this receiver, named here as blind adaptive multi-user detector (BA-MUD), supports completely asynchronous and uncoordinated transmissions and needs only essential information about all the users, i.e., the number of active users and the processing gain. In this receiver, a convergence procedure to desired user vector subspace is realized by exploiting low values of cross correlation between the informative sequence and interfering user signals and by resorting to a simple implementation of the steepest descent rule, with no further overhead but a proper energy threshold definition to prevent from cancellation of the desired signal.

Generalization of the adaptive blind detection to the case of asynchronous users and time invariant multipath scenarios² have been recently considered in several papers [7]–[14]: in particular, in [12]–[14] a minimum OE (MOE) receiver is derived with multiple (vector) constraints, thus allowing its utilization in a frequency selective environment. This procedure is based on a suitable combination of the multipath components of the user of interest and guarantees MAI minimization under appropriate constraints with no signal cancellation.

Nevertheless, in time-varying environments, benefits due to the adoption of this strategy are not fully exploited, mainly because the spreading waveform is not exactly known at the detector end; in fact, wireless fading channel causes additional multipath components or amplitude fluctuations.

Besides, it is important to highlight that blind adaptive algorithm convergence to OE local minimum becomes difficult to achieve in this case because signal amplitude variations due to

Manuscript received November 18, 1999; revised September 8, 2000.

The authors are with the Dipartimento di Elettronica e Telecomunicazioni, Università di Firenze, Firenze I-50139, Italy.

Publisher Item Identifier S 0018-9545(01)09847-4.

¹W-CDMA, CDMA2000, and TD-CDMA TDD standards are based on DS/CDMA technique.

²That is to say that multiple replicas are assumed to be received but their amplitude, phase, and delay values are supposed constant during the whole simulation.

fading phenomena imply variations of the OE functional and, as a consequence, of its local minimum.

The advanced blind adaptive MUD (ABA-MUD), proposed in this paper, overcomes this drawback by the introduction of a suitable window reprocessing method. In this scheme, faster convergence of the blind algorithm with respect to the classical approach is achieved by performing steepest descent algorithm more than once over the same informative bit frame, thus attaining a reduction of the time-varying channel impairments. This procedure can be described as a freezing of a particular frame in order to execute the same recursive operations for a proper number of times.

The organization of this paper is as follows. The system model together with the blind adaptive approach and the BA-MUD structure and performance in time invariant multipath channel are presented in Section II. The behavior of the proposed ABA-MUD in the case of a time-varying multipath fading channel is discussed in Section III. Finally, concluding remarks are given in Section IV.

II. BLIND ADAPTIVE MULTI-USER DETECTOR IN TIME-INVARIANT MULTIPATH CHANNEL

This section deals with a BA-MUD receiver in a time invariant multipath channel; in particular, each user signal is characterized by L replicas with constant delay, phase, and attenuation. This environment is defined here as multipath static channel (MSC).

Under the assumption of K asynchronous users, the received signal is equal to

$$r(t) = \sum_{k=1}^K \left(\sum_{l=1}^L A_{k,l} s_k(t - \tau_{k,l}) b_k \cos(\omega_0 t + \phi_{k,l}) \right) + n(t) \quad (1)$$

where

$A_{k,l}$	amplitude of l th replica of k th user;
b_k	k th user informative sequence, with a bit rate equal to R_b ;
$s_k(t)$	k th user spreading chip sequence, with a chip rate equal to R_c ;
$n(t)$	AWGN with two sided power spectral density equal to $N_0/2$;
$N = T_b/T_c$	processing gain, where T_b is the bit period and T_c the chip period;
K	total number of active users;
$\tau_{k,l}$ and $\phi_{k,l}$	l th replica k th user time delay and phase: they are independent identically distributed (i.i.d.) uniform random variables in $[0, T_b)$ and $[0, 2\pi)$, respectively.

The shaping of the bit and chips is rectangular.³ Bit values are i.i.d. random values with probability 0.5 in $\{\pm 1\}$. We assume knowledge of the spreading sequence of user of interest, but no other users spreading codes knowledge is assumed. Moreover, in the following, the receiver structure is considered after carrier recovery and chip-rate sampling, i.e., base-band equivalent

³This assumption is only for the simplicity of the analysis. Different pulse shapes may be adopted.

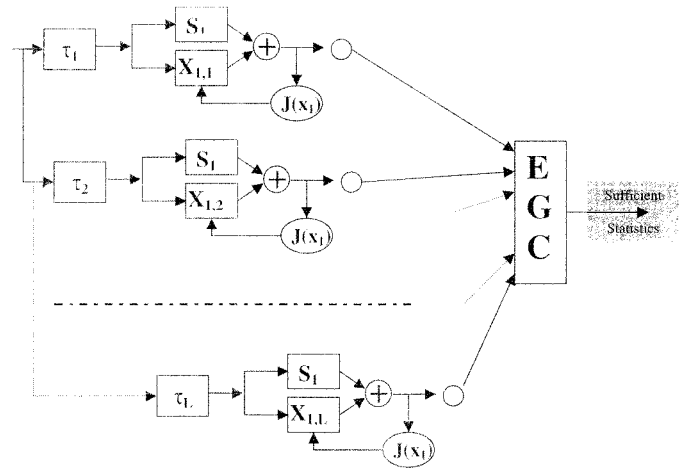

Fig. 1. BA-MUD for multireplica signals.

sampled signals are assumed. For convenience, the user of interest is assumed to be the first. The delay and phase of each signal replica is supposed to be perfectly tracked and compensated. Hence, without any loss of generality, $\phi_{k,l} = 0 \forall k, l$ is assumed.

As it is known [1], [2], any linear detector can be canonically represented as the sum of two orthogonal components, one equal to the signature waveform of the desired user, the other orthogonal to it. Hence, the canonical representation of the detector is the following:

$$c_1 = s_1 + x_1 \quad (2)$$

with

$$\langle s_1, x_1 \rangle = 0. \quad (3)$$

Moreover, the following constraint is assumed:

$$\langle c_1, s_1 \rangle = \|s_1\|^2 = 1. \quad (4)$$

An MOE detector is designed with the goal to minimize

$$E\{\langle y, s_1 + x_1 \rangle^2\} \quad (5)$$

where y is the base-band sampled received signal. This receiver has been demonstrated in [1] to be equivalent to the MMSE detector. In particular, the steepest descent algorithm is adopted in order to achieve an MOE BA-MUD. In this case, adaptive component x_1 for the considered detector results to be

$$x_1^{j+1} = x_1^j - \mu \langle y^j, s_1 + x_1^j \rangle (y^j - \langle y^j, s_1 \rangle s_1) \quad (6)$$

where j means adaptive algorithm time index, i.e., considered bit position from the start of the procedure. It has been demonstrated in [15] that this algorithm converges regardless of the initial condition to the MMSE detector if the step size μ decreases as $1/j$.

In an MSC environment, a generalization of the classical BA-MUD [1] is needed. In particular, the implementation solution considered here is based on the utilization of a single blind receiver for each signal replica (see Fig. 1) in order to face all the other replicas as pure interference. This receiver modification does not affect convergence procedure since each delayed signal is effectively seen as a further interfering

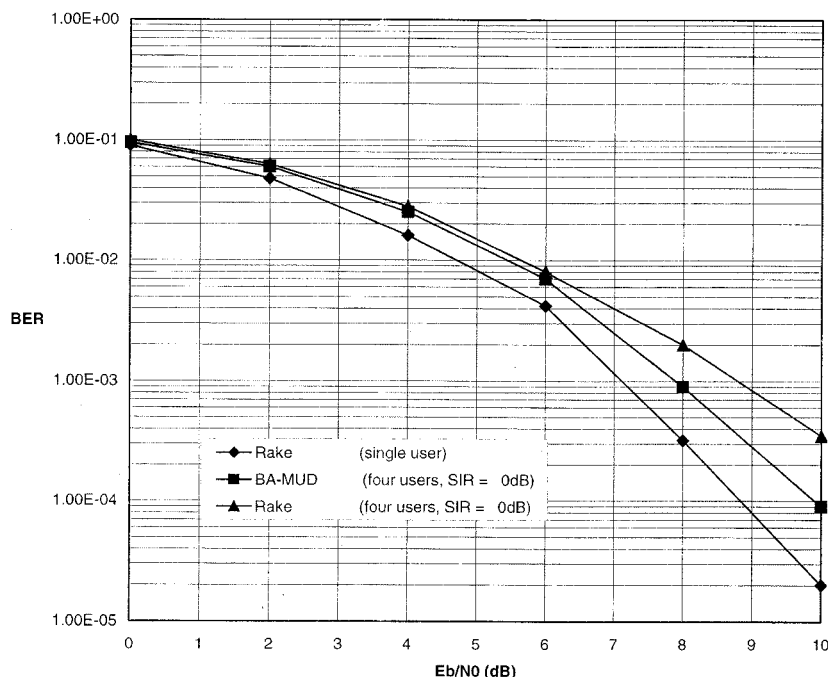

Fig. 2. BER comparisons (MSC channel, ideal power control).

user and its perturbation contribution is defined by signature waveform autocorrelation corresponding to the replica relative delays. In blind adaptive detection the definition of an energy threshold is mandatory to avoid cancellation of the desired user signal, eventually caused by signature waveforms mismatch. In particular, the receiver impulse response energy has to be constrained according to the following relation:

$$\|c_1\|^2 = \|s_1\|^2 + \|x_1\|^2 \leq 1 + \chi_I. \quad (7)$$

For this MSC environment, parameter $\chi_{I, \text{MSC}}$ is determined according to [1] as

$$\chi_{I, \text{MSC}} = \frac{2(LK - 1)}{N - 2(LK - 1)} \quad (8)$$

by assuming that any interfering replicas can be considered as an additional single-replica interfering user.⁴

Moreover, a new embedded adaptive procedure is considered: starting from (6), an adaptive impulse response $x_{1,l}$ $l = 1, \dots, L$ is derived for each single replica; if impulse response energy $\|x_{1,l}^j\|^2$ results to be less or equal than threshold $\chi_{I, \text{MSC}}$, adaptive algorithm is carried on, otherwise a new adaptive impulse response is defined as

$$\tilde{x}_{1,l}^j = \frac{x_{1,l}^j}{\|x_{1,l}^j\|} \cdot \sqrt{\chi_{I, \text{MSC}}}. \quad (9)$$

After this normalization, impulse response $\tilde{x}_{1,l}^j$ is assumed to be the receiver adaptive component and the recursive relation (6) is carried out with $x_{1,l}^j = \tilde{x}_{1,l}^j$.

For this adaptive procedure, a proper step size μ has also to be defined. In particular, according to [16], step size can be derived

⁴The value of parameter χ_i has been demonstrated to be related to number of interfering users [13]; errors in the determination of the number of replicas at the receiving end causes slight performance loss (see Section III).

as a function of the mean energy $\overline{E_{1,l}}$ at the output of the filter matched to the l th replica of user of interest as

$$\mu = \frac{0.1}{j \cdot \overline{E_{1,l}}} \quad (10)$$

where j is the algorithm index defined in (6) and $\overline{E_{1,l}} = (1/T_b) \int_0^{T_b} r(t) s_1(t - \tau_l) dt$. The same updating rule is assumed for each path, i.e., for each single BA-MUD.

Numerical results have been obtained in the MSC case by means of computer simulations assuming the following:

- binary PSK modulated signals with bit-rate equal to 31.496 Kb/s;
- spreading obtained through gold sequences with processing gain equal to 127;
- number of replicas L equal to six.

The BA-MUD performance in the case of three interfering users in an MSC environment is reported in Figs. 2–4: in particular, an ideal power control is assumed in Fig. 2, while 10- and 20-dB power unbalance between interfering signals and the user of interest has been considered in Figs. 3 and 4, respectively. As can be clearly seen, the BA-MUD shows an excellent near-far resistance even in critical MSC environments and fully prevents from the irreducible error floor of the conventional rake receiver.

For what concerns BA-MUD computational complexity, assuming that the normalization operation (9) happens with probability 0.5, for each bit, the following operations are accomplished:

$$- 8 \cdot N \quad \text{additions} \quad (11a)$$

$$- 8 \cdot N \quad \text{multiplications.} \quad (11b)$$

It is worth noting that if an oversampling operation is performed by considering N_s samples per chip, possible spreading waveforms mismatch is reduced. The computational complexity in this case may be, again, given by (11) via a substitution of N

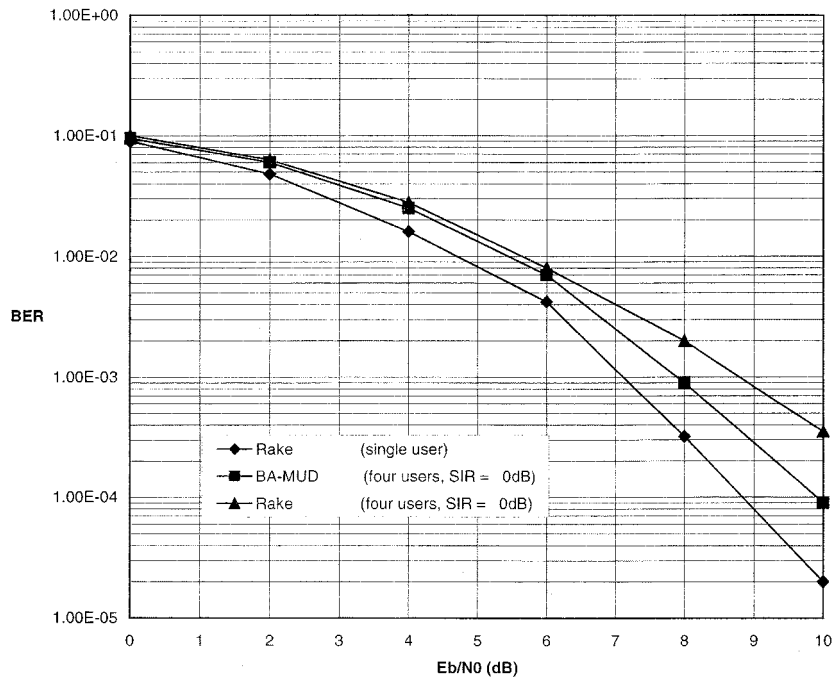

Fig. 3. BER comparisons (MSC channel, power unbalance between the desired user signal and the interfering signals equal to 10 dB).

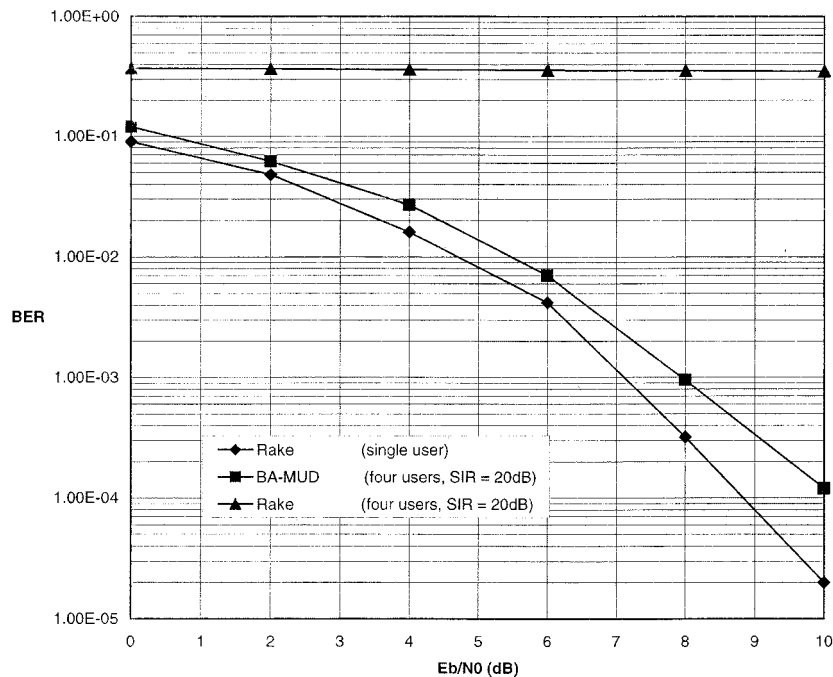

Fig. 4. BER comparisons (MSC channel, power unbalance between the desired user signal and the interfering signals equal to 20 dB).

with $N \cdot N_s$. For all the systems considered in this paper, oversampling has been exploited by taking two samples per chip in order to minimize coarse chip timing negative effects.

It is important to point out that, for the BA-MUD, the detection is not reliable until the recursive procedure has led to the proximity of the minimum output energy. Generally, this transient lasts from 10 to 20 times the spreading sequences length, e.g., in the case of a 127 chips Gold sequence signature wave-

forms, BER performance during the first 2000's bits is remarkably high. Moreover, if a new user begins transmitting after procedure convergence, a new transient period takes place. From these considerations, it is straightforward to note that any environment variation dramatically affects BA-MUD receiver performance.

The vulnerability to time varying phenomena of the BA-MUD receiver is highlighted in Figs. 8–10 where BER

performance is given for a typical multipath fading environment [20]. In this case, the BA-MUD is not able to converge to the OE local minimum before a location change happens: steepest descent algorithm is not as fast as it should to avoid performance degradation. In the next section, a modified BA-MUD is presented in order to lower this drawback at the expense of a light computational complexity increase.

III. ADVANCED BLIND ADAPTIVE MULTI-USER DETECTOR IN MULTIPATH FADING CHANNEL

In the case of a time-varying multipath fading channel (MFC), the received signal for each user is assumed to be composed of L replicas with constant relative delays: each replica amplitude and phase are time varying, the former having Rayleigh statistics, the latter being uniformly distributed in $[0, 2\pi)$

$$r(t) = \sum_{k=1}^K \left(\sum_{l=1}^L A_{k,l}(t) s_k(t - \tau_{k,l}) b_k \times \cos(\omega_0 t + \phi_{k,l}(t)) \right) + n(t). \quad (12)$$

The considered channel model has been derived in conformity with [16]: in particular a Rayleigh classical Doppler spectrum, generally known as CLASS, has been assumed with a Doppler spread equal to 100 Hz. Perfect knowledge of the delays and phase are assumed, i.e., these two parameters are tracked ideally, and phase compensation is performed by employing perfect mean value upon the whole bit epoch.

In order to face the BA-MUD drawbacks highlighted in the previous section, we propose here an advanced blind adaptive multi-user detector (ABA-MUD), based on a joint use of a window reprocessing procedure and a classical steepest descent strategy.

The informative bit data flow is divided in equal length frames that are buffered in the detector: the steepest descent algorithm (6) is performed upon the bits inside the frame, with the control operations addressed in (10); once the recursive procedure has been performed for each bit of the frame, the adaptive impulse response $x_{1,l}^j$ is used as a starting point for another iteration of the updating procedure upon the bits of the same frame. In the second iteration, the adaptive procedure attempts to obtain new values of the orthogonal sequence $x_{1,l}^j$ for each bit of the frame. In this way, the estimation accuracy is increased if the processing window is long enough to neglect correlation property between first and second iteration on the same bits. After the completion of second iteration, adaptive sequence final value is used to start third lap and so on. If $x_{1,l}^{n_b \cdot M_l + m}(i)$ indicates the adaptive impulsive sequence obtained for the l th replica of the user of interest at the i th iteration upon the same frame for the m th bit inside the n_b th frame, the adaptive procedure can be described as

$$\begin{aligned} x_{1,l}^{n_b \cdot M_l + m + 1}(i) &= x_{1,l}^{n_b \cdot M_l + m}(i) \\ &\quad - \mu \left\langle y^{n_b \cdot M_l + m}, s_1 + x_{1,l}^{n_b \cdot M_l + m}(i) \right\rangle \\ &\quad \times (y^{n_b \cdot M_l + m} - \langle y^{n_b \cdot M_l + m}, s_1 \rangle s_1) \\ \forall 1 < m \leq M_l, \quad \forall 1 \leq i \leq I_{MAX}, \quad \forall n_b \end{aligned} \quad (13a)$$

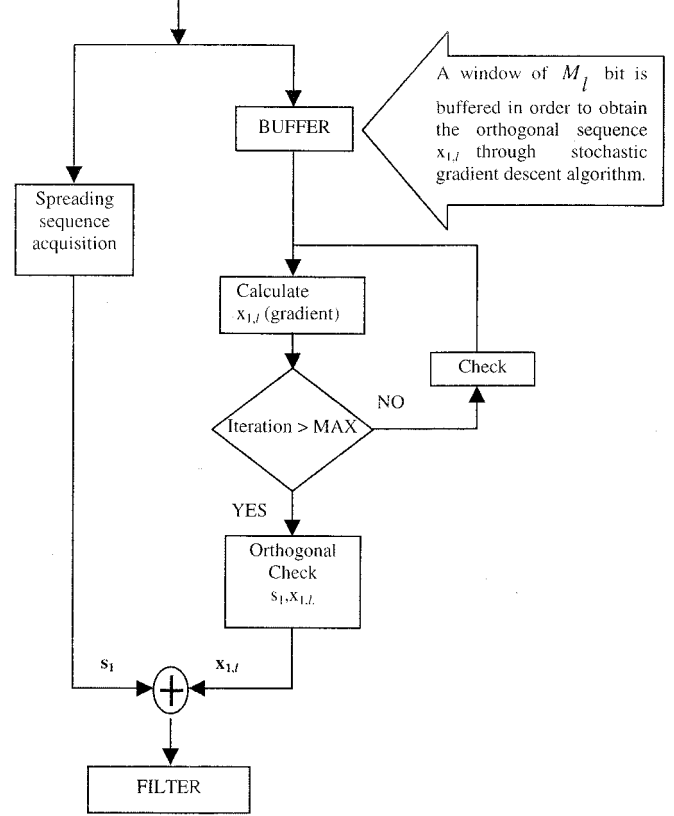

Fig. 5. Advanced blind adaptive multi-user detector (ABA-MUD) logical flow.

$$\begin{aligned} x_{1,l}^{n_b \cdot M_l + 1}(i+1) &= x_{1,l}^{n_b \cdot M_l + M_l}(i) \\ &\quad - \mu \left\langle y^{n_b \cdot M_l + M_l}, s_1 + x_{1,l}^{n_b \cdot M_l + M_l}(i) \right\rangle \\ &\quad \times (y^{n_b \cdot M_l + M_l} - \langle y^{n_b \cdot M_l + M_l}, s_1 \rangle s_1) \\ \forall 1 \leq i \leq I_{MAX}, \quad \forall n_b \end{aligned} \quad (13b)$$

where index i represents iteration number, i.e., the i th iteration upon the same frame, apex $n_b \cdot M_l + m$ locates the m th bit inside the n_b th frame, I_{MAX} , M_l and n_b indicate the maximum number of iterations per frame, the frame length and the buffer number, respectively. The adaptive procedure logical flow and graphical trajectory are sketched in Figs. 5 and 6. Any iteration of the above algorithm permits to obtain a more accurate definition of the adaptive impulse response and, as a consequence, a more reliable detection.

When the last iteration has been performed, normal steepest descent algorithm is restored starting from the first bit of the successive frames: as a general rule, the impulse response obtained for last bit of the previous window in the first iteration is used, thus saving the original trajectory of the steepest descent procedure. This interbuffer seam can be represented by the following relation:

$$\begin{aligned} x_{1,l}^{(n_b+1) \cdot M_l + 1}(1) &= x_{1,l}^{n_b \cdot M_l + M_l}(I_{MAX}) \\ &\quad - \mu \left\langle y^{n_b \cdot M_l + M_l}, s_1 + x_{1,l}^{n_b \cdot M_l + M_l}(I_{MAX}) \right\rangle \\ &\quad \times (y^{n_b \cdot M_l + M_l} - \langle y^{n_b \cdot M_l + M_l}, s_1 \rangle s_1) \quad \forall n_b. \end{aligned} \quad (13c)$$

The associated flow diagram is shown in Fig. 6(c).

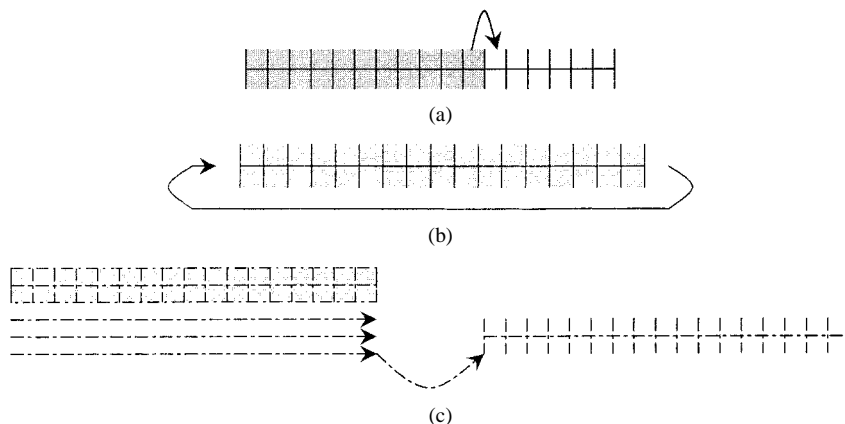

Fig. 6. ABA-MUD procedure trajectories.

For each bit inside the frame, (13a)–(c) determine orthogonal impulse response values, that are the starting points for the following step, i.e., for the successive bit; all the values of sequence $x_{1,l}^j$, corresponding to a particular iteration upon the frame, can be seen as a soft input for the following iteration on the same frame. In time-varying MFC's, iterating this procedure several times allows better performance than a direct hard detection.⁵ It is worth stressing that this approach cannot be considered as a decision-directed detector since no hard decision is performed before the completion of the iterative procedure.

In the proposed approach, the buffered frame is frozen and detected by means of the described iterative procedure while the successive incoming frame is stored in another buffer, in order not to lose any information. During iterative procedure baseband sampled received signal values $y^{m_b \cdot M_l + m}$ are frozen and processed without any variation between an iteration and the following. This convergence improvement takes place at the expense of a processing delay increase since complete buffer filling is needed before the second iteration and the following ones can be performed. Anyway, this additional delay, ideally equal to the bit epoch times the buffer length, is not too long: if a too long buffer is considered, channel features cannot be assumed constant for all the bits in the buffer since window duration could be comparable with channel coherence time. In this case, the proposed reprocessing technique would not cause better adaptive filter impulse response determination. As a consequence, buffer length has to be chosen according to the following condition:

$$M_l \cdot T_b \ll \Delta t_c \quad (14)$$

where Δt_c is the channel coherence time [17], in order to have negligible channel variation upon buffered bits.

Moreover, the number of iterations per frame cannot be arbitrarily high: in fact, apart the computational complexity increase assessed in the following, too many iterations would enhance the effects of the correlation properties between bits of interfering signals since iterations are performed on the same frame and performance degradation would be introduced. The proposed

⁵This philosophy of taking advantage of previous steps reminds turboencoding principles [21].

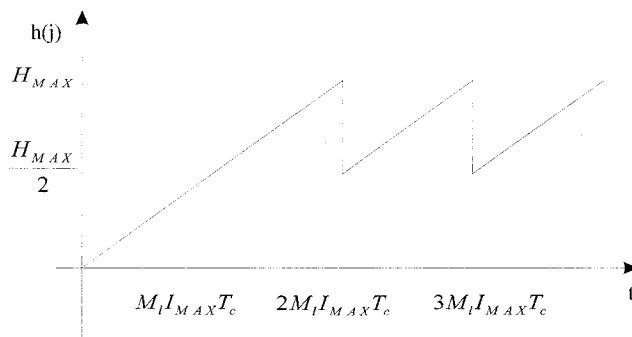

Fig. 7. Step index function.

approach is equivalent to consider adaptive procedure upon a sequence composed by the same frame repeated as many times as the number of iterations; hence, performing a great number of iterations would mean to deny the MOE and MMSE detectors equivalence (see proposition 1 in [1]).

As a consequence, the iteration number is to be properly chosen in order to achieve a tradeoff between benefits due to window reprocessing in facing time-varying MFC and drawbacks due to correlation property and complexity.

As for the BA-MUD, in the proposed ABA-MUD receiver a single detector per replica is introduced so that the contribution due to the other paths are again faced as pure interference. Moreover, the step updating rule (10) has been modified in order to achieve best adaptation to a time varying environment. In particular, the monotonous decreasing rule proposed by Györfi in [15] does not seem to be a proper choice because of variations of the output energy local minimum produced by fading phenomena.

Hence, the following step updating rule has been adopted:

$$\mu(j) = \frac{0.1}{\frac{1}{10} \sum_{p=0}^9 E_{1,l}(j-p)} \cdot \frac{1}{h(j)} \quad (15)$$

where parameter $h(j)$ increases linearly from 1 to H_{MAX} and, successively, from $H_{MAX}/2$ to H_{MAX} as sketched in Fig. 7. In this way, the opposite requests of fast tracking and stable convergence are both assured.

It is worth stressing that, since the considered user received power is time-varying, the output energy of the filter matched

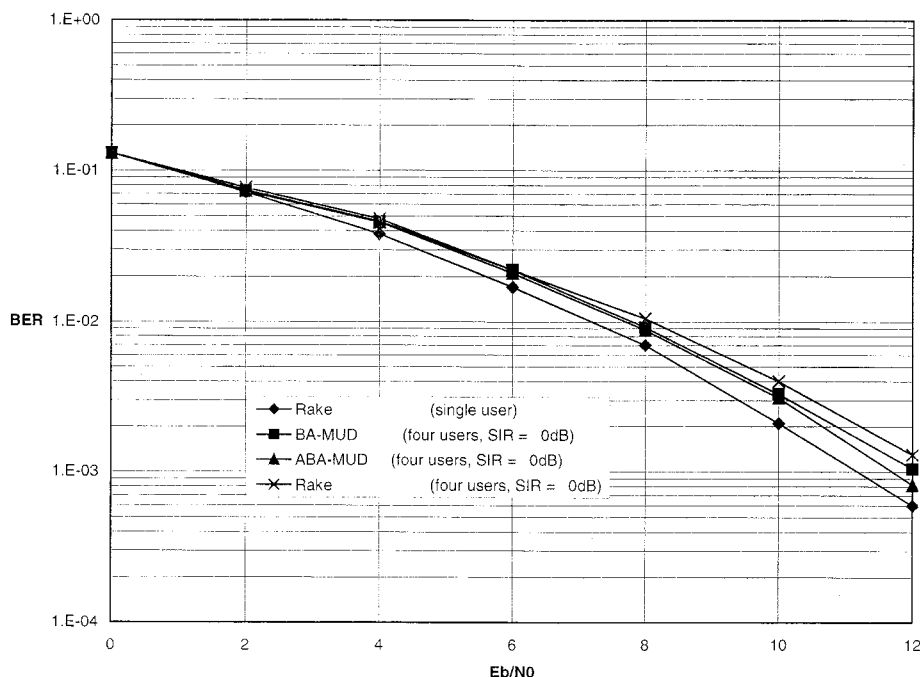

Fig. 8. BER comparisons (MFC channel, ideal power control).

to the l th replica of the desired user $\overline{E}_{1,l}$ has to be replaced in (15) by the term

$$\frac{1}{10} \sum_{p=0}^9 \overline{E}_{1,l}(j-p) \quad (16)$$

that represents the desired user l th replica received energy averaged on a ten bit epochs interval: this solution helps keeping a fair evaluation of the desired signal energy.

As for the MSC environment, a new value of parameter χ_I has to be defined by taking into account that time varying phenomena cause strong mismatch between the nominal signature waveform and the received one. Threshold $\chi_{I,MFC}$ expression can be derived from (8) as

$$\chi_{I,MFC} = \frac{\tilde{\alpha}(LK-1)}{N - \tilde{\alpha}(LK-1)}. \quad (17)$$

Because of model complexity, analytical determination of the proper energy threshold does not seem to be possible so that an optimization procedure has been carried out by computer simulation in order to determine the value of parameter $\tilde{\alpha}$ that causes the lowest desired signal suppression.

Numerical results have been obtained in the MFC case by means of computer simulations assuming that

- binary PSK modulated signals with rate equal to 31.496 Kbits/s;
- spreading obtained through gold sequences with processing gain equal to 127;
- number of signal replicas L equal to six;
- buffer length M_t equal to 40;
- number of iterations I_{MAX} equal to 25;
- maximum step value H_{MAX} equal to 2000.

The delay and phase of each signal replica are ideally tracked and compensated at the receiving end.

It is worth emphasizing that all the paths are again assumed to be discriminated at the receiving end and that the iterative procedure (13) is individually performed for each signal replica of the user of interest in order to fully exploit potential benefits of the proposed algorithm.

Since in practical applications some of the received replicas of the signal of interest sometimes may not be discriminated, performance loss may be introduced. Anyway, for each discriminated replica the adaptive procedure keeps on facing whole interference and, as a consequence, performance loss is only due to a not complete exploitation of the rake diversity.⁶ In the case that all the signal replicas are discriminated but their number results to be greater than L , only the strongest L replicas have to be considered in order to lower performance loss.

Figs. 8–10 show the BER performance of the ABA-MUD in comparison with a classical rake receiver and BA-MUD for a case of an MFC environment and three interfering users. An ideal power control is assumed in Fig. 8, while 10- and 20-dB power unbalance between interfering signals and the user of interest has been considered in Figs. 9 and 10, respectively.

As it can be clearly seen in these figures, the ABA-MUD receiver remarkably improves BA-MUD performance; it is worth stressing that the 2-dB gain shown by the ABA-MUD in Figs. 9–10 with respect to BA-MUD allows a sensible reduction of BER irreducible floor with a consequent capacity improvement for DS/CDMA wireless systems.

For each system considered, a different optimization procedure of parameter $\tilde{\alpha}$ is needed: in general, the bigger the MAI contribution is, the greater the part of the signal to be suppressed is, the longer adaptive algorithm has to be carried out to eliminate its impairments on the detected signal. As a consequence, since implementation of the proposed receiver

⁶It is important to point out that wrong determination of delay is likely to happen for weaker replicas, thus implying slight performance loss.

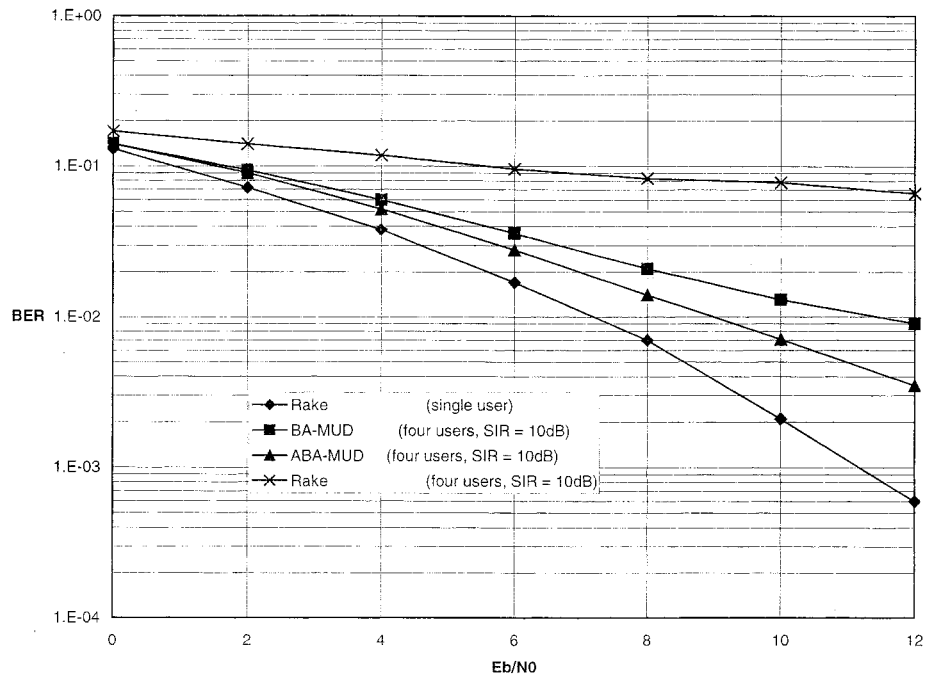

Fig. 9. BER comparisons (MFC channel, power unbalance between the desired user signal and the interfering signals equal to 10 dB).

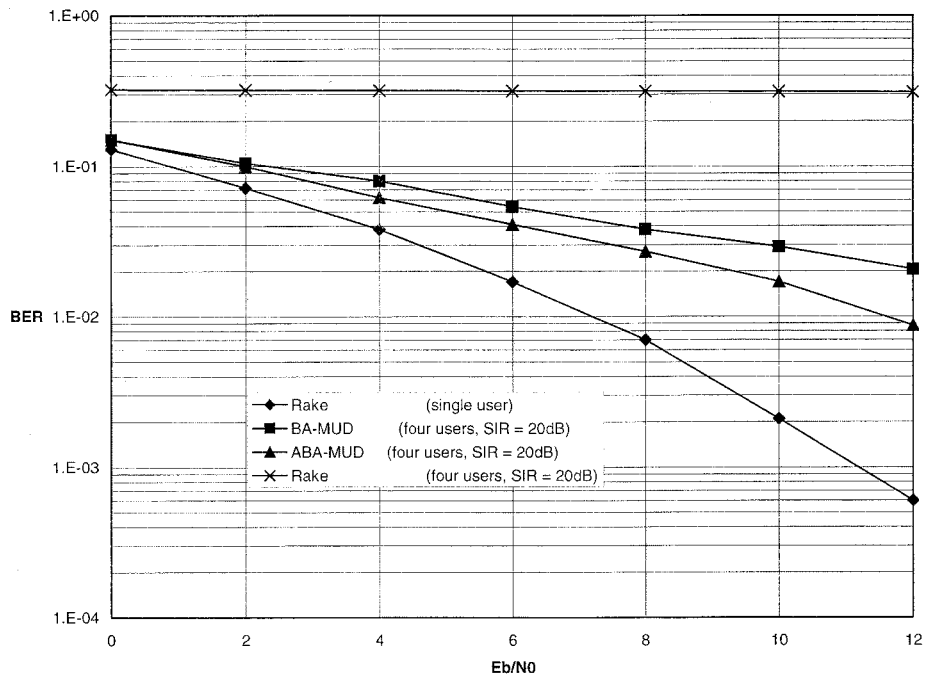

Fig. 10. BER comparisons (MFC channel, power unbalance between the desired user signal and the interfering signals equal to 20 dB).

in wireless channel cannot prevent from energy threshold appropriate determination, rough knowledge of MAI interference level is needed. This requirement seems not too hard to be fulfilled since any loose transmission power control (TPC) is based on these measurements and future third-generation standard explicitly demands fast TPC.

For what concerns ABA-MUD transient behavior, it is important to note that the convergence condition is reached

very quickly thanks to the window reprocessing technique: the target of this procedure is to reach the proximity of the minimum output energy for each frame and, consequently, reliable detection can be obtained after very few frames (typically two), even if a new user starts a transmission. Therefore, it is possible to state that any environment change does not appreciably affect ABA-MUD receiver performance.

For what regards ABA-MUD computational complexity, it can be noted that for each bit, the following operations per user are accomplished:

$$-\frac{5NM_t + 2N}{M_t} \cdot I_{MAX} \cong 5 \cdot I_{MAX} \cdot N \quad \text{additions} \quad (18a)$$

$$-\frac{6NM_t + 2N}{M_t} \cdot I_{MAX} \cong 6 \cdot I_{MAX} \cdot N \quad \text{multiplications} \quad (18b)$$

Computational burden is nearly equal to BA-MUD complexity times the number of iteration upon the buffered stream so that an adequate processing speed has to be granted. Even if computational complexity increase is apparent, it is worth stressing that this approach permits to obtain a complexity value per user that does not depend on the number of users in the system: if multiple users have to be detected as in any typical base station, total complexity is linear in the number of users.

As for the previous schemes, oversampling has been exploited also for the ABA-MUD. Hence, evaluation of implementation complexity in terms of number of operations can be still achieved by (18) via substitution of N with $N * N_s$.

IV. CONCLUDING REMARKS

In this paper, an adaptive blind detector suitable for DS/CDMA wireless communication systems, ABA-MUD, has been proposed. The main features of such a detector are moderate complexity and joint utilization of the time diversity and adaptive blind processing techniques.

Detector motivation lies in the purpose of limiting growing impairments undergone by classical blind adaptive detector, in time varying systems: this goal is achieved by the introduction of a window reprocessing technique in order to improve performance, even in multipath fading environment.

Moreover, the ABA-MUD requires knowledge of the same channel parameters needed by the conventional single-user receiver and, as in BA-MUD schemes, no training sequence is needed. Besides, only essential information about the number of active users, the processing gain and a rough knowledge of MAI interference level, i.e., desired user SIR evaluation, is requested for an accurate setting of the recursive algorithm. Finally, the proposed detector gives rise to a moderate complexity increase in comparison with the classical blind detector.

REFERENCES

- [1] M. L. Honig, U. Madhow, and S. Verdú, "Blind adaptive multi-user detection," *IEEE Trans. Inform. Theory*, vol. 41, pp. 944–960, July 1995.
- [2] S. Verdú, *Multisuser Detection*. Cambridge, U.K.: Cambridge Univ. Press, 1998.
- [3] P. Rapajic and B. Vucetic, "Adaptive receiver structures for asynchronous CDMA systems," *IEEE J. Select. Areas Commun.*, vol. 12, pp. 685–697, May 1994.
- [4] S. Miller, "An adaptive direct-sequence code-division multiple-access receiver for multi-user interference rejection," *IEEE Trans. Commun.*, vol. 43, pp. 1746–1755, Apr. 1995.
- [5] U. Madhow and M. L. Honig, "MMSE interference suppression for direct-sequence spread spectrum," *IEEE Trans. Commun.*, vol. 42, pp. 3178–3188, Dec. 1994.
- [6] M. Abdulrahman, A. U. Sheikh, and D. D. Falcomer, "Decision feedback equalization for CDMA in indoor wireless communications," *IEEE J. Select. Areas Commun.*, vol. 12, pp. 698–706, May 1994.

- [7] H. Huang and S. Verdú, "Linear differentially coherent multiuser detection for multipath channel," *Wireless Personal Commun.*, vol. 6, no. 1–2, pp. 113–136, Jan. 1998.
- [8] R. De Gaudenzi, F. Giannetti, and M. Luise, "Design of a low-complexity adaptive interference-mitigating detector for DS/SS receivers in CDMA radio networks," *IEEE Trans. Commun.*, vol. 46, pp. 125–134, Jan. 1998.
- [9] D. You and T. J. Lim, "A modified blind adaptive multiuser detector," in *Proc. 1998 Int. Symp. Spread Spectrum Techniques and Applications*, Sun City, South Africa, Sept. 1998, pp. 878–882.
- [10] J. Shen and Z. Ding, "Blind adaptive multi-user CDMA detection based on a linear projection constraint," in *Proc. 1997 IEEE Signal Processing Workshop Signal Conf.*, Paris, France, Apr. 1997, pp. 261–264.
- [11] H. Liu and K. Li, "Low complexity receivers for CDMA communications over frequency-selective channels," in *Proc. SPAWC'97*, Paris, France, Apr. 1997, pp. 261–264.
- [12] M. K. Tsatsanis and Z. Xu, "Performance analysis of minimum variance CDMA receivers," *IEEE Trans. Signal Processing*, vol. 46, pp. 3014–3021, Nov. 1998.
- [13] —, "Adaptive blind interference cancellation in CDMA systems," in *Proc. GLOBECOM'99*, Rio de Janeiro, Brazil, Dec. 1999.
- [14] J. B. Schodorf and D. B. Williams, "A constrained optimization approach to multi-user detection," *IEEE Trans. Signal Processing*, vol. 45, pp. 258–262, Jan. 1997.
- [15] L. Györfi, "Adaptive linear procedure under general conditions," *IEEE Trans. Inform. Theory*, vol. IT-30, pp. 262–267, Mar. 1984.
- [16] R. F. Smith and S. L. Miller, "Acquisition performance of an adaptive receiver for DS-CDMA," *IEEE Trans. Commun.*, vol. 47, pp. 1416–1424, Sept. 1999.
- [17] J. G. Proakis, *Digital Communications*, 3rd ed. New York: Mc Graw-Hill, 1995.
- [18] U. Madhow and M. L. Honig, "MMSE detection of CDMA signals: Analysis for random signature sequences," in *Proc. IEEE Int. Symp. Inform. Theory*, San Antonio, TX, Jan. 1993.
- [19] S. Y. Miller, M. L. Honig, M. Shensa, and L. Milstein, "MMSE reception of DS-CDMA for frequency-selective fading channels," in *Proc. IEEE Int. Symp. Inform. Theory*, Ulm, Germany, July 1997, p. 51.
- [20] *GSM Recommendations 05.05*.
- [21] C. Berrou and A. Glavieux, "Near optimum error correcting coding and decoding: Turbo-codes," *IEEE Trans. Commun.*, vol. 44, pp. 1261–1271, Oct. 1996.

Enrico Del Re (M'78–SM'84) was born in Florence, Italy, in 1947. He received the Dr. Ing. degree in electronics engineering from the University of Pisa, Pisa, Italy, in 1971.

Until 1975, he was engaged in public administration and private firms involved in the analysis and design of the telecommunication and air traffic control equipment and space systems. Since 1975, he has been with the Department of Electronics Engineering, University of Florence, Florence, Italy, first as a Research Assistant, then as an Associate Professor, and since 1986 as Professor. During the academic year 1987–1988, he was on leave from the University of Florence for a nine-month period of research at the European Space Research and Technology Centre, European Space Agency, The Netherlands. He is the head of the Digital Signal Processing and Telematics Laboratory of the Department of Electronics and Telecommunications of the University of Florence. He is a member of the Executive Board of the Italian Interuniversity Consortium for Telecommunications (CNIT). His main research interest are digital signal processing, mobile and satellite communications and communication networks, on which he has published more than 150 papers, in international journals and conferences. He is the Co-Editor of *Satellite Integrated Communications Networks* (Amsterdam, The Netherlands: North Holland, 1988), one of the authors of *Data Compression and Error Control Techniques with Applications* (New York: Academic, 1985) and the editor of *Mobile and Personal Communications* (Amsterdam, The Netherlands: Elsevier, 1995) and *Software Radio Technologies and Services* (New York: Springer-Verlag, 2001).

Dr. Del Re has been the Chairman of the European Project COST 227 Integrated Space/Terrestrial Mobile Networks and the EU COST Action 252 Evolution of Satellite Personal Communications From Second to Future Generation Systems. He received the 1988/1989 premium from the Institute of Electrical Engineering, U.K., for the paper "Multicarrier demodulator for digital satellite communication systems." He is a member of the European Association for Signal Processing (EURASIP).



Romano Fantacci (S'82–M'87–SM'91) was born in Pistoia, Italy. He received the Dr.Ing. degree in electronics engineering and the Ph.D. degree in telecommunication engineering, both from the University of Florence, Florence, Italy, in 1982 and 1987, respectively.

In 1982, he joined the Electronics and Telecommunications Department, University of Florence, first as Researcher, then as an Associate Professor and currently as Full Professor of Telecommunication Networks. During the first stage of his research activity, he worked on satellite communication systems. In particular, he has been involved in several European Space Agency (ESA) and INTELSAT advanced research projects. He is the author of several publications, some of which have been published in the most acknowledged journals in communication science. He has also been involved in several European and nationwide research projects. His present research interests involve digital communications, computer communications, queueing theory, fast packet switching, and mobile communication networks.

Simone Morosi (S'97) was born in Florence, Italy, in 1968. He received the Dr.Ing. degree in electronics engineering and the Ph.D. degree in information and telecommunication engineering from the University of Florence, Florence, Italy, in 1996 and 2000, respectively.

Since 2000, he has been with the Department of Electronics and Telecommunications, University of Florence, as a Research Assistant. His present research interests involve code-division multiple-access communications, multi-user detection techniques, adaptive antenna array systems, turbo coding, digital communications, and third generation mobile communication standards.

Andrea Pugi was born in Florence, Italy, in 1970. He received the Dr.Ing. degree in electronics engineering from the University of Florence, Florence, Italy, in 1998.

From 1998 to 2000, he was with the Florence Department of Marconi Communication, Florence, Italy, as part of the Technical Support Project Staff for Mobile TETRA product. Since 2000, he has been with the Infogroup S.P.A., Florence, Italy, as the Account and Project Manager, where he is responsible for bid management, sales, and project manager processes.