

# Running dynamics and contact mechanics comparison of two freight bogies running in plain line and through switches and crossings

G. Megna<sup>1</sup>, H. Magalhaes<sup>2,3</sup>[0000-0001-7070-7958], Y. Bezin<sup>2</sup>[0000-0002-0599-8696] and A. Bracciali<sup>1</sup>

<sup>1</sup> Department of Industrial Engineering, Università degli Studi di Firenze, Firenze, Italy

<sup>2</sup> Institute of Railway Research, University of Huddersfield, Huddersfield, UK

<sup>3</sup> LAETA, IDMEC, Instituto Superior Técnico, Universidade de Lisboa, Portugal

gianluca.megna@unifi.it

**Abstract.** The present joint research deals with the evaluation of the running dynamics and contact mechanics of two different freight bogies, the “standard” Y25 and the innovative 4L. The behavior of this lightweight bogie is compared to the Y25 using several track irregularities, to analyze the effect of a new primary suspension arrangement and its track friendliness. Stationary and transient vertical response of the bogies are used as relevant parameters for irregularities on tangent track at the maximum speed and different loading conditions. The paper also focuses on the impact of the new bogie when running on switches in both diverging and through directions.

**Keywords:** Freight bogie, Y25 bogie, 4L bogie, Track forces, Switches and Crossings

## 1 Introduction

The reference bogie of this comparative study is the Y25 type, which runs across Europe for more than 50 years. Owing to its simplicity and to a continuous design and manufacturing optimization process, it is the absolute benchmark in a market that has always considered investment (capital) costs more important than life cycle costs. Purchasing cost of a modern Y25 bogie is extremely low, and this makes developing new bogies extremely challenging. It is well known that Y25 has limitations in terms of “smoothness” of running dynamics, steering capability and vertical suspension behavior due to a highly non-linear friction damping mechanism (the “Lenoir link”). However, they were a reasonable combination in the ‘60s and still ensure an acceptable behaviour although at limited speeds, in the order of 100 km/h.

Previous attempts led to the development of improved bogies regarding running dynamics (as retro-fits of Y25, Leila bogie, TF25, LTF25, etc.) but none of these proved to significantly erode market slices to Y25 [1]. This is mainly due to the presence of

2

“delicate” components such as rubber elements (subject to ageing) or viscous dampers (subject to maintenance) and often to complex architectures, including two-stage suspension or disc brakes.

Preliminarily the bogies are compared in terms of safety against derailment ( $Y/Q$ ) and track shifting forces ( $\Sigma Y$ ) according to EN14363 [2] evaluating both wheels unloading due to track twist and lateral guiding forces in a tight radius and flat curve. Then, the paper focuses on the comparison of Y25 and 4L in a number of typical and/or critical running situations involving speed, track irregularities and loading conditions. The primary goal of the research is to analyze the interaction between empty, partially laden and fully laden vehicles and a tangent track with different kinds of vertical track quality (local defects or representative section irregularities). The 4L peculiar suspension arrangement has indeed a static stiffness equal to the Y25 but a half stiffness under local loads acting on a wheel at a time and it performs better in terms of track friendliness for all kind of defects that are not entire fractions of the wheelbase. The behaviour when running through switches is analysed as well, to find out any improvements to be gained, especially for short switches where conventional freight vehicles have proven particularly damaging with regards to their poor curving performance in the diverging direction, as well as leading to high vertical impact loads in crossing panels.

## 2 The 4L bogie

The 4L bogie uses full metal friction elements and a continuously increasing stiffness with no sharp changes while keeping the interface elements of the classical Y25 frame. Being an inside frame (inboard bearings) bogie, its running dynamic properties are markedly better than the Y25 thanks to a 15% lighter architecture and a 30% reduction of the yaw moment of inertia [3]. **Fig. 1** shows the main frame of the innovative bogie composed by 1: pyramidal frame; 2: supporting arm for side bearer and brake calipers for wheel web mounted discs (or compact tread braking units); 3: centre bowl; 4: side bearers; 5: horizontal coil springs with single-stage progressive stiffness; 6: swinging arm; 7: non-rotating axlebridge for AIR Wheelset [4] (or inboard bearings axle). The primary suspension acts in longitudinal direction and each spring connects the two swinging arms on one side and consequently the two wheelsets, replacing the eight springs used on each side of a Y25 bogie. Therefore, vertical movements of the wheelset and the bogie are transformed in horizontal movements by the swinging arm and energy is dissipated by friction (load dependent) in the cylindrical pin connection between the arm and the frame. The cylindrical pin is composed by wear resistance elements in manganese steel. The bogie is designed with a conventional centre bowl and two side bearers, to guarantee a straightforward replacement on standard wagons. With the inside frame architecture, it is possible to reduce the overall dimensions with respect to a conventional Y25 bogie and the mass of the main frame results in about 1000 kg. AIR Wheelset mass is about 1400 kg with wheel web mounted brake discs and brake calipers weight 100 kg each. The final mass of the bogie equipped with AIR Wheelset and brake discs is therefore 4200 kg. Brake calipers and discs impact on the total mass is considerable and the version with with inboard bearings wheelset with thermostable

wheels (about 1100 kg) and four compact tread braking units (60 kg each) can reduce further the weight up to 3600 kg.

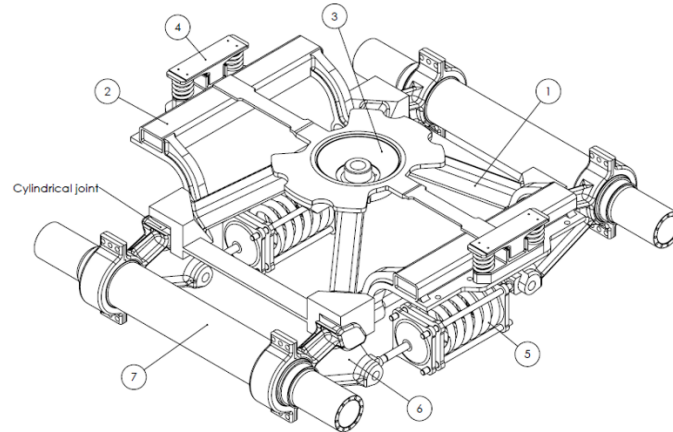

**Fig. 1.** Sketch of the main frame of the innovative bogie. Each component is described inside the text.

The multibody modelling of this bogie is made considering the centre bowl as a spherical joint with Coulomb friction with a friction coefficient  $\mu=0.2$ , while side bearers are modelled by means of non-linear elastic elements considering a 1 mm clearance in longitudinal direction before solid-to-solid contact (modelled with high stiffness) and a preload of 16 kN in vertical direction. Vertical stiffness is  $5.7 \times 10^5$  N/m, and a maximum vertical movement of 12 mm is allowed before solid-to-solid contact. Friction is modelled according to Kolsch method with a friction coefficient  $\mu=0.35$ . The swinging arms are connected with a cylindrical joint connection to the frame and Coulomb friction is added with  $\mu=0.3$ .

### 3 Model of the reference bogie Y25

The multibody model of the freight vehicle featuring the two Y25 bogies comprises one carbody supported by two bogies through the centre bowls and side bearers. Each carbody-bogie interconnection consists of a set of a bushing and a spherical friction element, representing the forces developed in the centre bowl and in the side bearers. Each side bearer is represented by a notional mass that is constrained to move in the horizontal plane of the carbody and a set of bushing and frictional elements are considered to connect the bogie frame. Thus, the transversal forces are mainly transmitted through the centre bowl, while the carbody weight and yaw resistance is distributed between the centre bowls and side bearers. In turn, each bogie comprises two wheelsets and four axleboxes that are assembled at the extremities of the wheelsets, allowing the rolling of the wheelsets with respect to the axleboxes. The suspension elements that interconnect the axleboxes and the bogie frame consists of the primary suspension. The

4

tare spring, which supports part of the suspended masses, is modelled by a spring element characterized by a stiffness in the vertical, lateral and longitudinal directions. Although the laden spring serves to support suspended masses when carrying enough weight, this component is modelled with a bumpstop with a vertical clearance of 6 mm in tare conditions. Another bumpstop element is used to model the lateral primary bumpstop that limit the lateral relative motion between the wheelsets and the bogie frames. The dissipative forces developed in the frictional surfaces are represented by a friction model which depends on the carbody weight, where the normal force in the contacting surfaces is made through the Lenoir link.

## 4 Simulated scenarios

The two multibody models are developed with the VI-Rail software package [5] to investigate the dynamic behaviour of the new bogie. Three loading conditions has been modelled: empty (5.5 t/axle), half loaded (11 t/axle) and fully loaded (22.5 t/axle).

### 4.1 Safety against derailment

Derailment coefficient has been evaluated considering method 2 of EN14363, measuring the lateral force  $Y_a$  of the outer wheel on flat track with radius  $R = 150$  m and no transition and the minimum vertical force  $Q_{\min}$  due to a twist of 0.42% applied during static test.  $(Y/Q)_a$  has then been calculated according to

$$\left(\frac{Y}{Q}\right)_a = \frac{Y_a}{Q_{\min} + (Y_a + Y_i)\frac{h}{s}} \quad (1)$$

in which  $Y_i$  is the lateral force on the inner wheel,  $h$  is height of application of lateral forces (i.e. the wheel radius) and  $s$  is distance between contact points (i.e. 1500 mm). Both bogies show a maximum derailment ratio lower than the safety limit of 1.2 (1.06 for the Y25 and 1.01 for the 4L). Obviously, the empty is the most critical condition due to the highest wheel unloading and therefore the lower value of  $Q_{\min}$ . However, it is worth to highlight that the maximum value of the lateral force  $Y_a$  occurs in different zones while the bogies approach the flat curve. **Fig. 2** shows the lateral forces of the outer leading wheels of the two bogies in empty conditions. While the stationary value for the Y25 is about 15 kN, the peak value at the beginning of the curve is almost double and it is higher than the 4L for about 20 m. Both zones are evaluated according to EN14363, to consider the influence of the presence of both leading and trailing bogies inside the curved track portion. It is worth to highlight that in this running condition (5 km/h) the steering effect due to the 4L suspension arrangement is completely avoided, as the non-compensated acceleration and therefore the roll angle of the wagon is zero.

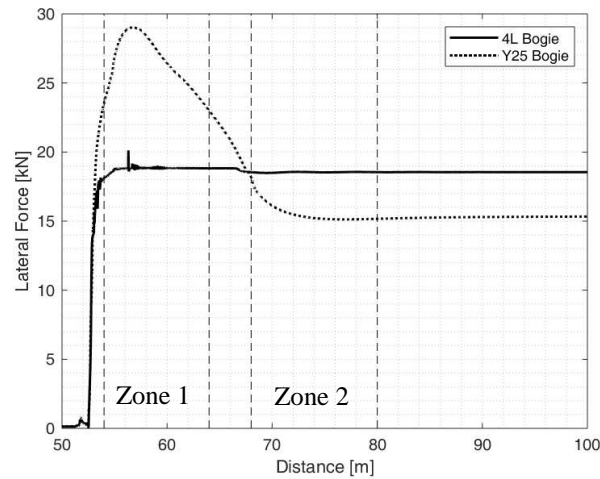

**Fig. 2.** Lateral force of outer leading wheel of both bogies in empty conditions. According to EN14363, the track is divided in zone 1 (only the first bogie is entered in the curve) and zone 2 (both bogies are entered in the curve).

#### 4.2 Sinusoidal vertical irregularities

The horizontal suspension arrangement is particularly effective on vertical uneven track, without introducing rubber element or hydraulic dampers. This is particularly true for such irregularities with wavelengths that let two wheels on the same side to move in counterphase, generating a suspension “short-circuit effect” which is able to equalize the vertical contact force between the front and the rear wheel. This effect is not possible on a conventional suspension system as the two wheelsets are always free to move independently. While this kind of behavior has been already evaluated considering random PSD vertical irregularities in [3], in this paper simulations on a track with sinusoidal defects are performed. The wavelengths of these irregularities are chosen to let the wheels move in phase, in counterphase and in quadrature, while the excitation frequency has been set to 10 Hz in order to keep a wide range of speed with wavelengths values closest as possible to bogie wheelbase ( $1.2 \div 3.6$  m). The resulting speeds are from 45 km/h to 130 km/h and a summary of the whole set of simulations is shown in **Fig. 3** (left). The irregularities are in phase on both the rails, in order to get an in-plane movement of the vehicle and to avoid cross effect due to twist and the stationary value of the dynamic vertical force is evaluated and compared between the two bogies.

The natural equalization offered by the “short-circuit” effect of the suspension is clearly visible in **Fig. 3** (right), in which the vertical contact force of the first wheel running over the uneven track section is plotted for the 1.2 m wavelength defect. As the two wheelsets move in counterphase the two swinging arms act on the spring with the same direction and its stationary reaction is zero, resulting in a nearly perfect equalization of the load between the wheels.

6

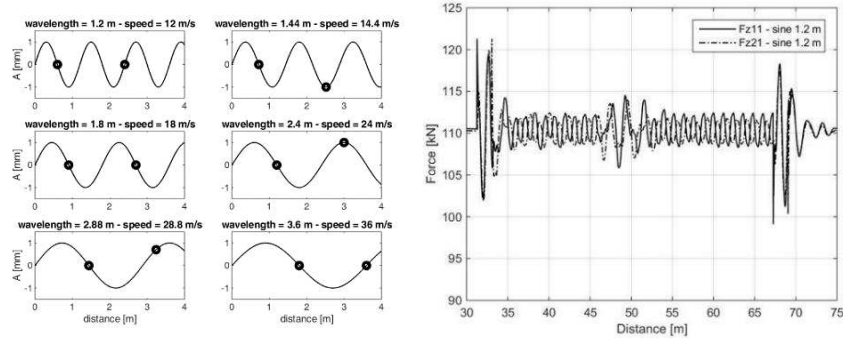

**Fig. 3.** Left: summary of the simulated sinusoidal irregularities (dots represent the wheel position). Right: “Short-circuit effect” of the 4L bogie for the 1.2 m wavelength case in laden condition.

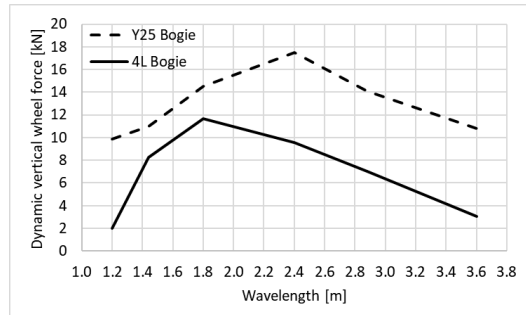

**Fig. 4.** Dynamic vertical force plotted against the wavelength in laden condition.

As expected the maximum dynamic force is reached for the 4L bogie at the wavelength of 1.8 m, while a reduction of 8 kN is obtained when the wheelsets move in counterphase, i.e. at wavelength of 1.2 m and 3.6 m. This difference reduces up to 2 kN in partially laden and in the empty case.

### 4.3 Locally isolated defect

These kinds of defects are usually responsible for high frequency impact forces influenced mainly by unsprung masses and track stiffness [6]. However, for frequencies up to 10÷20 Hz, the track has very little effect and a great part of the dynamic force is due to the suspension reaction. Therefore, to evaluate the response of the new suspension, a short-ramped defect has been created and simulated. This is shown in **Fig. 5** and it is characterized by a wavelength of 1.25 m, that at 25 m/s can give an excitation up to 20 Hz. Higher frequencies are not interesting as the elasticity and the structural vibrations of single components become more important and rigid bodies are not suitable for that kind of evaluation.

7

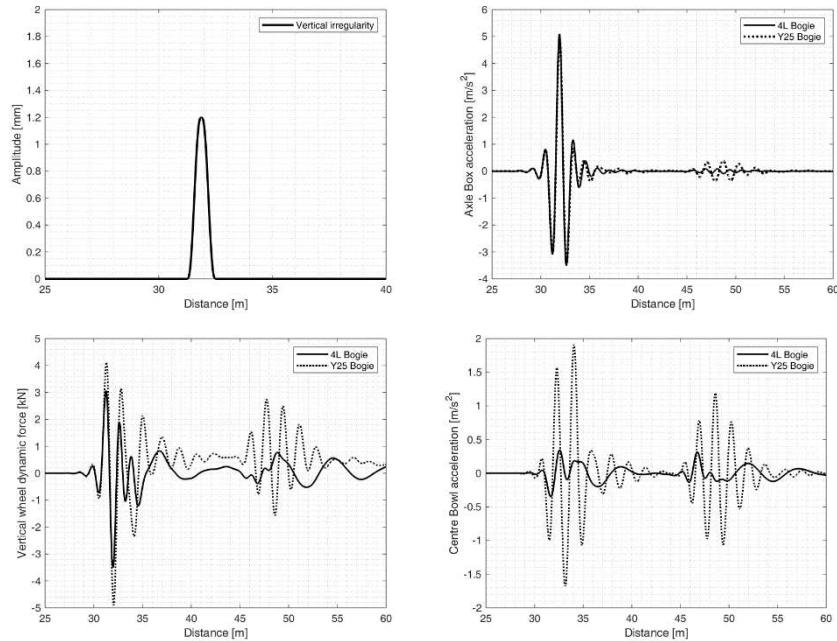

**Fig. 5.** Up-left: representation of the local defect (applied to both rails). Up-right: vertical axlebox acceleration. Below-left: Vertical wheel dynamic force. Below-right: Centre bowl acceleration. Signals are shown for the empty case.

Acceleration at the axlebox level and at the centre bowl level have been evaluated as well as the vertical dynamic force at the contact point. All the signals were low-pass filtered at 20 Hz to cut out all the higher frequencies. As shown in **Fig. 5**, even if the acceleration at the axlebox level is the same, the acceleration over the bogie frame at the centre bowl, is strongly reduced. The higher value of centre bowl acceleration for the Y25 ( $3.4 \text{ m/s}^2$ ) is found for the partially laden case, mainly due to the discontinuity of the primary suspension stiffness in these conditions, while the axlebox acceleration remains nearly constant (about  $5 \text{ m/s}^2$ ) between the load cases for both bogies. However, the difference between the peak dynamic force increase with the static load, as shown in **Fig. 6**, resulting in a beneficial effect of the suspension.

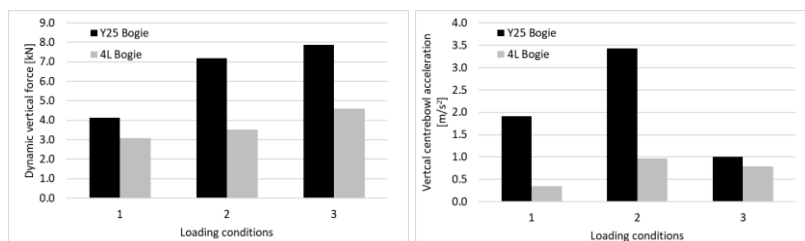

**Fig. 6.** Dynamic vertical force (left) and vertical centre bowl acceleration (right) in empty condition (1), partially laden condition (2), fully laden condition (3).

#### 4.4 Switches and Crossings

The Network Rail CV 56E1 vertical switch panel is a short switch used on lines with 56kg rail sections, covering most of the British rail network and still common on intercity lines (up to 200km/h). Rails are installed vertical to ease the fixing/baseplate designs onto concrete or oak bearers. The lead length between toe and crossing nose is 25.025 m and a switch radius of 245.767 m matching that of the turnout curve for the natural crossing angle of 1 in 9.25. This gives a maximum turnout speed of 43km/h. The switch 3D geometry, produced in the In2Track EU project [7] project has been reproduced using the actual machining operation (cutting tools and path) on a nominal CEN56E1 switch rail, including inside head cut (interface switch-stock rail), switch head cut (corner radius and plane) and topping. Individual cross sections are then extracted from the 3D geometry in longitudinal steps of 100 mm for the switch, as shown in **Fig. 7**. The dynamic behavior in the previously described switch has been simulated in both through and diverging directions. In the first case the dynamic vertical force of the wheel passing over the toe and the switch rail has been evaluated at the reference speed of 80 km/h, while in the second case the wear number of the outer wheel (front and rear) has been considered. All the time histories have been filtered at 20 Hz. The results are described in **Fig. 8** for the through case and **Fig. 9** for the diverging case, both considering the laden condition.

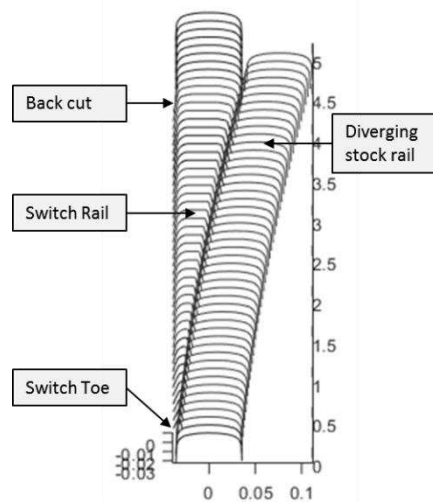

**Fig. 7.** Components for the CEN56E1 vertical switch showing the rail cross sections defined for simulation

As shown in **Fig. 8** the benefits of the new suspension with respect to the vertical response of the vehicle are not only confirmed but even more evident due to the very poor behavior of the Y25 bogie, which shows very high values.



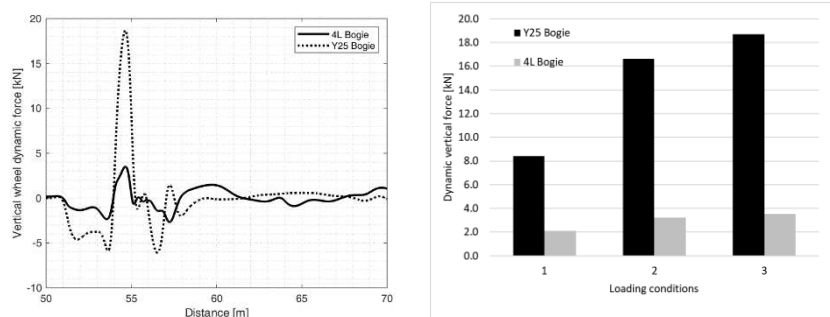

**Fig. 8.** Left: Vertical dynamic force in the laden case. Right: Vertical dynamic peak force in empty condition (1), partially laden condition (2), fully laden condition (3). Reference speed 80 km/h.

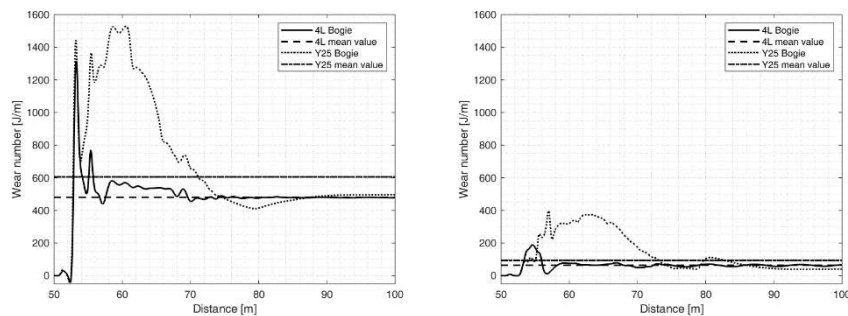

**Fig. 9.** Wear Number of the front right wheel (left) and the rear right wheel (right) at the maximum speed of 43 km/h. Dashed lines represent the mean value calculated over the length of the diverging part of the switch.

The results in terms of wear number must be discussed according to the considered zone of the switch. The initial peak value at switch toe is practically the same for both bogies for the leading wheel, while the rear wheel of 4L bogie initially increases more rapidly than the Y25's but quickly comes back down. While negotiating the diverging part of the switch the Y25 shows a large increase of the wear number covering almost the entire lead length between toe and crossing nose. Significant wear will ensue, which is not the case for the 4L bogie. Beyond the lead length, the stationary value is about the same for both bogies but the mean value (calculated as the area under the wear number curve divided for the length of the curved part of the switch) is always favorable for the new bogie. In conclusion the new bogie would impose far less wear than current freight bogies in the initial transition areas of switch panels, where severe wear leads to increased maintenance and early switch rail replacement.

## 5 Conclusions

The comparison between the standard freight bogie Y25 and an innovative bogie named 4L has shown how a lighter design combined with a new suspension arrangement can improve the dynamic behavior especially considering the vertical response of the bogie. The dynamic vertical contact force is naturally reduced and equalised by only two single stage progressive springs, that connect the two wheelsets.

The new bogie shows superior features in all the simulated scenario, and therefore a better track friendliness of the developed suspension in the vertical direction. The bogie shows comparable behavior also in terms of lateral contact forces and wear numbers in the switch rail, with even smoother steering due to the lower mass, lower moment of inertia around the vertical axis and simpler friction damping system. Wear of the switch toe and the switch rail can be therefore reduced with savings in terms of maintenance time and costs.

Even if improvements and further investigations must be performed the concept of the innovative 4L proves to be a valid alternative with respect to the classical Y25.

## References

1. Iwnicki S.D., Stichel S., Orlova A., Hecht M.: Dynamics of railway freight vehicles, *Vehicle System Dynamics*, 53(7), 995-1033 (2015).
2. EN 14363:2016. Railway applications – Testing and Simulation for the acceptance of running characteristics of railway vehicles – Running behaviour and stationary tests.
3. Bracciali A., Megna G.: Track friendliness of an innovative freight bogie, In: Li Z., Nunez A. (eds.), 11th International Conference on Contact Mechanics and Wear of Rail/Wheel Systems (CM 2018), pp. 81-89, Delft, The Netherlands, September 24-27, 2018.
4. Bracciali A and Megna G. Inside Frame Bogies & Air Wheelset A Winning Marriage. In: 10th International Conference on Railway Bogies and Running Gears, Budapest, Hungary, 12-15 September 2016.
5. Vi-Grade Engineering Software & Service. Vi-Rail 18.0 Documentation, Vi-Grade GmbH, 2017.
6. Jenkins H.H, Stephenson J.E, Clayton G.A et al. The effect of track and vehicle parameters on wheel/rail vertical dynamic forces. *Railway Engineering Journal* 1974;
7. EU Report D2.2, In2Track project “Enhanced S&C Whole System Analysis, Design and Virtual Validation”, S2R-CFM-IP3-01-2016.